

Your partner for
Innovative connections

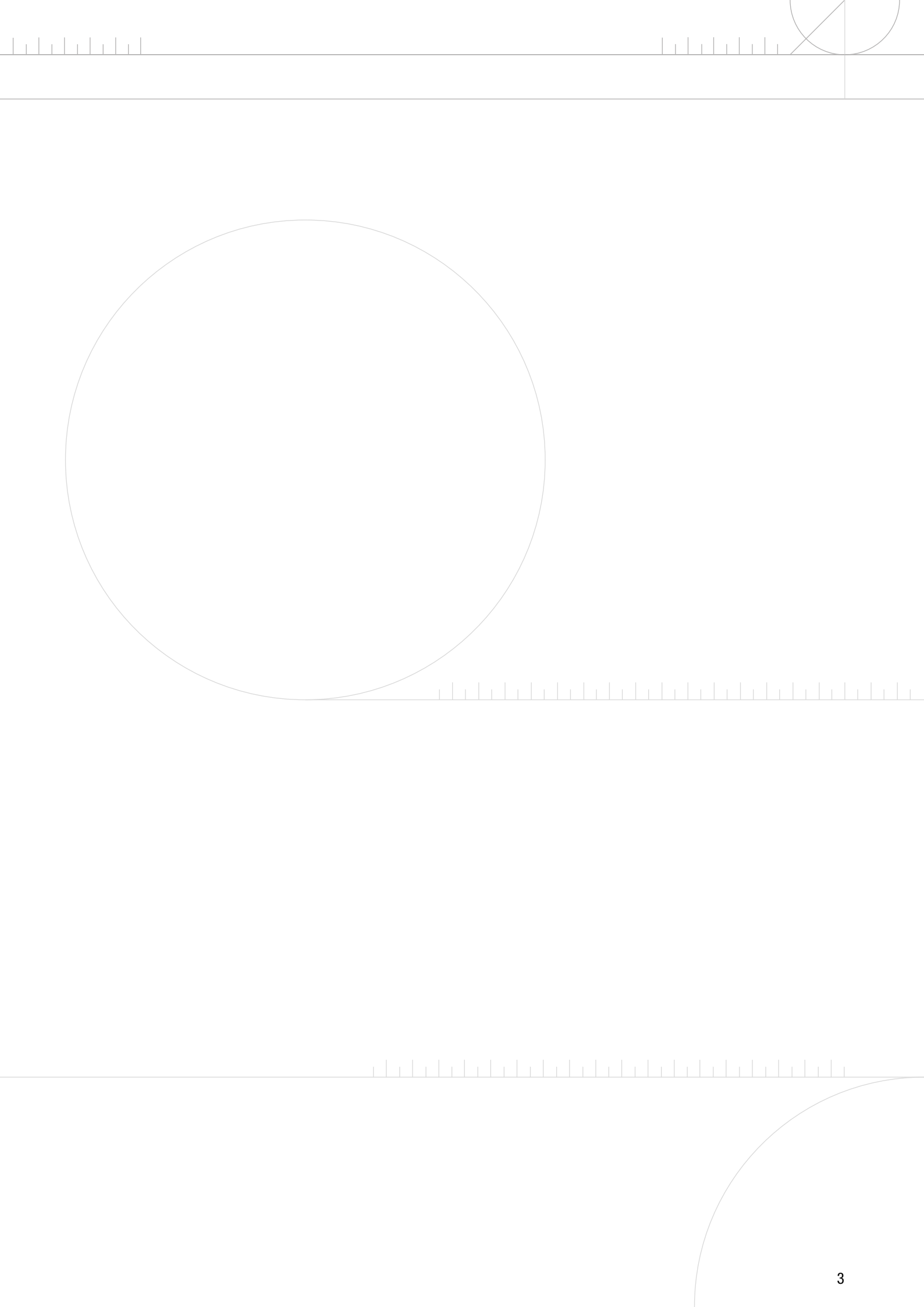

NORMA[®] DISTRIBUTION SERVICES

**INCLUDING
24 NEW
PRODUCTS**



NORMA® – Your partner for innovative connections



Naturally – **you demand the best**

Wherever you are in the world, and whenever you need superior clamping products, there is always one of our products for your first choice.

For over sixty years we have been dedicated to working closely with our suppliers and customers to develop products that achieve outstanding functional performance. We enjoy support from dedicated employees, all of whom have the goal of exceeding the expectations that customers bring us on a daily basis.

Hose clamps, pipe connections, retaining products or plastic products. Regardless of its use, every NORMA brand product is designed, produced and delivered within the framework of a certified quality-management system. This development procedure is essential for achieving the innovative yet robust designs demanded by end-users.

Our distribution partners rely on both the quality we offer and our cooperation and support. Quality has always been and remains our hallmark.

About **NORMA Group**

NORMA Group is a global market and technology leader with strong growth prospects in attractive niche markets for engineered joining technologies.

The company manufactures and sells a wide range of high-quality engineered joining technology solutions in three product categories: clamp, connect and fluid. These are often mission-critical for the performance, reliability and quality of the respective customer end products.

Headquartered in Maintal, Germany, NORMA Group operates a global network of 30 production facilities as well as numerous sales and distribution sites across Europe, the Americas, and Asia-Pacific. The company offers more than 40,000 high-quality products and solutions to approximately 10,000 customers in a wide range of industries, including agricultural machinery, commercial vehicles, construction equipment, engines, aviation, infrastructure/construction/water management, passenger vehicles, railway, white goods, wholesalers and technical distributors.



NORMA Group distributes its products in more than 100 countries using two distinct ways-to-market: Engineered Joining Technology (“EJT”) and Distribution Services (“DS”). In the EJT way-to-market, NORMA Group delivers customized, engineered solutions meeting the specific application requirements of original equipment manufacturers. In the DS way-to-market, the company sells a wide range of high-quality standardized engineered joining technology products for a broad range of applications through various distribution channels under its well known brands ABA®, BREEZE®, NORMA®, R.G. RAY®, Serflex®, Serratub®, TERRY® and Torca®.



NORMA® Quality



For NORMA Group quality is an all-embracing value, ranging from product design to delivery and beyond, to cover all aspects of the Group's activity including its service to customers.

Regardless of the sector in which a NORMA product is to be used, that product will be designed, produced and delivered within the framework of a IATF 16949 certified quality-management system developed for the critical demands of the automotive industry. An impeccable development procedure is essential to achieving robust designs and delivering optimal product quality.

Within this context, Advanced Product Quality Planning (APQP) and associated quality tools such as Failure Mode and Effect Analysis (FMEA) are all fundamental to the development of reliable parts and error-proof production processes. Checks carried out during production are in accordance with control plans and best performed automatically, removing operator influence. NORMA's production lines are mostly automated, as befits a Group in the forefront of its industrial sector.



Teamwork and **Superior products**

“The high quality of our products, solutions and services relies on close collaboration with our customers.”

At NORMA, teamwork is a decisive watchword, ensuring, for example, that workshop operators and engineers combine their very specific experience and work together on product design and production practicalities. In order to meet customer delivery schedules, Production and Logistics work in close collaboration, ensuring on-time delivery of materials from sub-suppliers. NORMA's careful attention to these factors – and indeed to all aspects of quality – contributes to the all-round excellence for which the Group is known. In addition, NORMA's products are nothing less than remarkable, from a performance and reliability point of view, offering technical solutions that are among the leaders of the industry.



A spirit of **partnership**

Just as product development requires good dialogue between NORMA and its' customers, so quality performance during production and delivery involves the closest communication. Besides the internal tracking system with which NORMA monitors and analyzes its own performance, the Group applies so-called “8D” methodology to production-phase problem solving, liaising closely with customers in a spirit of transparency.

Continually striving to improve quality, delivery and service performance, NORMA aims to remain a market leader through its solutions, maintaining a benchmark level that customers can rely on.



Product development – a creative partnership with customers



As the leading solution provider in its sector, the NORMA Group's aim is to always stay a step ahead in innovation and the development of new products. NORMA's strengths as a solution provider are considerable.

To start with, the unrivaled breadth of our product range – the result of continually developing new solutions for our customers' needs – puts the Group in a class of its own. Offering both plastic fluid systems and a vast range of metal clamps and couplings, NORMA can often propose different solutions for a single application. New product development benefits from extensive lifetime-testing and validation facilities that allow NORMA to carry out virtually all necessary tests in-house, and to analyze each and every solution and application thoroughly and effectively.

Foresight and anticipation

Developing the right products and ensuring they are ready for customers at the right time requires thinking ahead – often as much as five years – keeping abreast of legislation that will impact future technical specifications. In the automotive sector, for example, NORMA continually strives to enhance its complete solutions for exhaust after-treatment, help customers improve the efficiency of their engines and develop systems that perform optimally at higher mechanical and thermal stresses. Technical requirements in all NORMA's markets are becoming more challenging. The Group works closely with its customers' pre-development departments to discuss their plans and initiate and prioritize development projects related to future applications.

“By closely following worldwide statistics concerning market growth and future markets, we attempt to discern mega-trends and further anticipate tomorrow’s product requirements.”



A resourceful partner

In addition to responding to customer solution requests, NORMA is proactive in proposing new solutions developed from studying current and future market needs. The Group's business model is based on succeeding through creative technical leadership rather than being a “follower” in the market. NORMA drives cutting-edge innovation for its customers.







Materials explanation

MATERIALS EXPLANATION	
W1	All parts entirely made from galvanized steel
W2	NORMACLAMP® TORRO®: Band and housing stainless steel AISI 430; Screw: Galvanized mild steel NORMACLAMP® GBS: Band and housing stainless steel AISI 439; Bolt: Galvanized mild steel NORMACONNECT® FGR/DCS: see pages 68 and 96
W2B	Band: stainless steel AISI 430 Screw and housing: galvanized steel
W3	All parts entirely made from stainless steel AISI 430
W4	All parts entirely made from stainless steel AISI 304 (or comparable)
W5	All parts entirely made from stainless steel AISI 316 (or comparable)





Materials International standard designations						
	DIN	AISI/AS	BS	AFNOR NF	SS	SUS
W1	Entirely galvanized steel					
Band and housing						
W2	1.4016	430	430 S 17	Z8 C17	2320	430
Bolt	Galvanized steel					
W3	1.4016	430	430 S 17	Z8 C17	2320	430
W4	1.4301	304	304 S 15	Z6 CN 18-09	2332	304
W5	1.4401	316	316 S 31	Z3 CND 17-11-1	2347	316
Spring insert	1.4310	301	301 S 22	Z12 CN 18-09	2331	301

Bolts

BOLTS	
Bolt type	Meaning
M	Bolt thread diameter in mm
Sk 	Hexagonal-head bolt
Sz 	Slotted hexagonal-head bolt
Zy 	Cylinder-head bolt
Isk 	Inside hexagonal screw

Pictogram explanation

NORMA® offers different tools, kits, assortments and displays to fit the needs of its customers. The drawings below will help you to know, at a quick glance, if the product is available in another packaging type and/or if it has a special tool.

PICTOGRAM	
Pictogram	Meaning
	A tool exists for this product, please refer to the Assortment chapter
	This product is available in a kit, please refer to the Assortment chapter
	This product is available in an assortment box, please refer to the Assortment chapter
	This product is available in display, please refer to the Assortment chapter

PRODUCT FAMILY	PRODUCT CATEGORY	PRODUCT NAME	PAGE
WORM DRIVE HOSE CLAMPS	PLAIN BAND	TORRO®	20
		TORRO® WF	23
		TORRO® TORQUE CAP	25
		TORRO® THUMBSCREW	26
		TORRO® TAMPERPROOF	27
		TORRO® NOTCH	28
		TORRO® PREFIX SYSTEM	28
		TORRO® PREFIX SYSTEM WF	28
		TORRO® PREFIX CLIP	29
		NEW: TORRO® PREFIX DOUBLE CLIP	29
		TORRO® RADIAL INSERT	29
	TORRO® SAFETY CAP	30	
	NEW: TORRO® SAFETY COLLAR	30	
	HD	31	
	PERFORATED BAND	HI-TORQUE	32
	PROFILE BAND	NEW: CC CLAMP	33
	QUICK LOCK	QUICK LOCK 9 MM	34
		QUICK LOCK 12 MM	36
		STRIP STEEL	37
		QUICK LOCK HOUSING	38
HEAVY DUTY CLAMPS	TRUNNION CLAMPS	GBS HOLLOW TRUNNION	39
		GBS STC	41
		GBS QRC	42
		GBS MULTI PART	43
QUICK RELEASE	STANDARD	SVS	44
		SVS P	46
		SVS EYELET BOLT	46
RETAINING CLAMPS	METAL	S/SP	47
		SP SINGLE	49
		SP DOUBLE	49
		SPGU	49
		HMK	50
		HMK SINGLE-PART HEAVY DUTY	52
		HMK TWO-PART HEAVY DUTY	52
HMK K1	52		
ONE PIECE CLAMPS	SCREWLESS CLAMP	COBRA	53
	SPRING BAND HOSE CLIPS	FBS	55
		FBS R	57
		FBS C	57
		FBS HC	57
		FBS MC	57
EAR CLIPS	ONE EAR CLIPS	EARCLIP SINGLE	58
		EARCLIP SAFE	59
		NEW: CV BOOT CLAMP	60
	TWO EAR CLIPS	EARCLIP DOUBLE	61

PLAIN BAND



PERFORATED BAND



PROFILE BAND

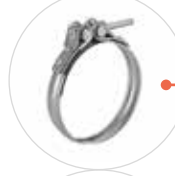

NEW

QUICK LOCK



TRUNNION CLAMPS

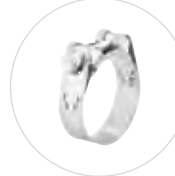

QUICK RELEASE



RETAINING CLAMPS



SCREWLESS CLAMP



SPRING BAND HOSE CLIPS



EAR CLIPS



CV BOOT CLAMP

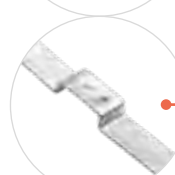

NEW

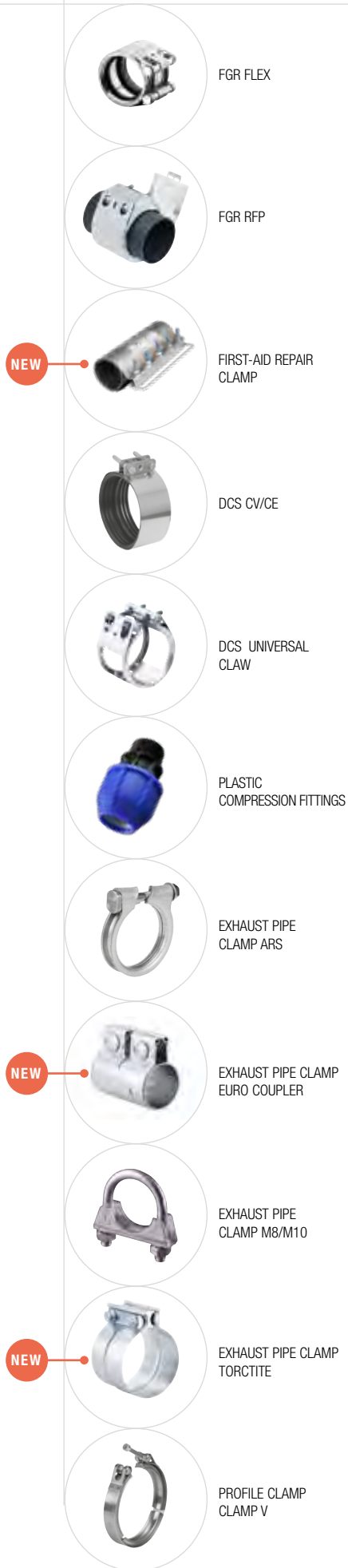

PRODUCT FAMILY	PRODUCT CATEGORY	PRODUCT NAME	PAGE
INFRASTRUCTURE CONNECTORS	FGR	FLEX now also available with FKM sealing sleeve	69
		FLEX E	72
		FLEX 3	74
		GRIP now also available with FKM sealing sleeve	77
		GRIP E	80
		GRIP E-FP	82
		RFP	84
		PLAST GRIP	85
		PLAST GRIP E	86
		COMBI GRIP	87
	COMBI GRIP E	88	
	SUPPORT SLEEVE	89	
	REP E	91	
	NEW : FIRST-AID REPAIR CLAMP	93	
	DCS	RAPID	98
		RAPID MSM	99
		CV/CE	100
		SVE	101
		UNIVERSAL CLAW	102
		RECORD CLAW	103
COMPRESSION FITTINGS	PLASTIC COMPRESSION FITTINGS	MALE THREADED ADAPTOR (MA)	108
		FEMALE THREADED ADAPTOR (FA)	108
		MALE THREADED TEE (MT)	109
		FEMALE THREADED TEE (FT)	109
		MALE THREADED ELBOW - MALE BEND 90 (MB)	110
		FEMALE THREADED ELBOW - FEMALE BEND 90 (FB)	110
		STRAIGHT COUPLER (SC)	111
		EQUAL BEND (EB)	111
		EQUAL TEE (ET)	111
		END CAP (EC)	112
		REDUCING COUPLER (RC)	112
		REDUCING TEE (RT)	113
		FLANGE ADAPTOR (FLA)	113
		POP-UP EQUAL BEND (PE)	113
WALL PLATE ELBOW (WPE)	114		
MALE THREADED ADAPTOR WITH BRASS INSERT (MAB)	114		
FEMALE THREADED ADAPTOR WITH BRASS INSERT (FAB)	114		
FEMALE THREADED BEND WITH BRASS INSERT (FBB)	114		
PIPE CLAMPS	EXHAUST PIPE CLAMP	SEC	115
		ARS	116
		RS/DIN	118
		ACCUSEAL	120
		DURASEAL	122
		ACCULOCK	123
		NEW : EURO COUPLER	124
		PIPE CLAMP M8/M10	125
		EASYSEAL	126
		NEW : TORCTITE	127
WIDE BAND CLAMP	BRS / BRSP	128	
	PROFILE CLAMP	V STC	129
V QRC		133	
V SVS		133	

PRODUCT FAMILY	PRODUCT CATEGORY	PRODUCT NAME	PAGE
BANDING SYSTEMS	POLYAMIDE CABLE TIES	CABLE TIE WHITE	136
		CABLE TIE BLACK	136
		CABLE TIE COLORED	136
		NEW: CABLE TIE WITH METAL BARB	138
	STAINLESS STEEL CABLE TIES	NEW: STAINLESS STEEL TIE BALL LOCKING	139
	ENDLESS BAND	NORMETTA® SMOOTH BAND	141
		NORMETTA® STAMPED BAND	141
		NORMETTA® PERFORATED BAND	141
	BUCKLES	NB-A	142
		NB-D	142
		NB-G	142
		NB-H	143
		NB-K	143
FIXING CLIPS AND STRAPS	RUBBER CLIPS	RSGU 1	144
		RSGU 0	146
		RSGU 2	147
		NEW: RSGUV 1	148
	METAL CLIPS	RS 0	149
		RS 1	150
		RS 2	151
		NEW: RSV 1	152
		NEW: BSL	153
		NEW: BSN	157
		NEW: BSS	158
	NEW: BS	159	
	PLASTIC CLIPS	NEW: HVAC CLIP	160
MOUNTING ELEMENTS	TUBE CLAMP FITTINGS	SLEEVE JOINT	163
		EXPANDING CONNECTOR	163
		90° ELBOW	163
		SHORT T	164
		LONG T	164
		WALL FLANGE	164
		RAILING BASE FLANGE	165
		HANDRAIL BRACKET	165
		3 WAYS 90° ELBOW	165
		CORNER C/W THROUGH TUBE	166
		TWO SOCKET CROSS	166
		SIDE OUTLET TEE	166
		FOUR WAY CROSS AND CENTER	167
		FIXING PAD	167
		DOUBLE WALL COUPLER	167
		MALE SWIVEL	168
		FEMALE SWIVEL	168
		GATE EYE	168
		GATE HINGE	168
		DOUBLE MALE SWIVEL	169
		90° CORNER MALE SWIVEL	169
	90° CROSSOVER	169	
	SINGLE SWIVEL COMBINATION	170	
	BASE SWIVEL COMBINATION	170	
	DOUBLE SWIVEL COMBINATION	170	
	90° CORNER SWIVEL COMBINATION	171	
	SHORT TEE SWIVEL	171	
	CLAMP ON TEE	171	
	FENCE BUILDING CLAMP	171	
	TRAFFIC SIGN FIXATION	ALU BAND CLAMP	172
	UNIVERSAL UCC	173	

POLYAMIDE CABLE TIES



STAINLESS STEEL CABLE TIE



NEW

ENDLESS BAND

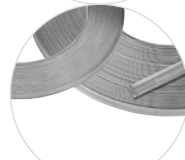

BUCKLES



RUBBER CLIP



METAL CLIPS



METAL CLIPS



HVAC CLIP









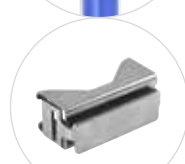

NEW

TUBE CLAMP FITTINGS

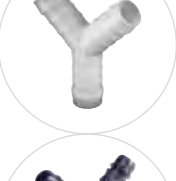
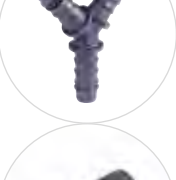

TRAFFIC SIGN FIXATION

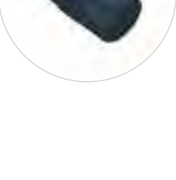

		PRODUCT FAMILY	PRODUCT CATEGORY	PRODUCT NAME	PAGE
	HOSE CONNECTORS TES	PLASTIC FITTINGS	HOSE CONNECTORS	SV	176
				GES	178
	HOSE CONNECTORS WES			BST	179
				TES	179
				WES	180
				GS	181
				GRS	181
				TS	181
				KS	182
				TRS	182
	HOSE CONNECTORS GS			YRS	182
				WS	183
				YS	183
				GN	183
	HOSE CONNECTORS KS			TN	184
				WN	184
				YN	184
				EG	185
				EWS	185
				ETS	185
	HOSE CONNECTORS YRS	ET	186		
		EW / WV	186		
		VT / VTR	187		
		VG / VGR	187		
	HOSE CONNECTORS YN				
	HOSE CONNECTORS ET				
	HOSE CONNECTORS EWS				
	HOSE CONNECTORS EW/WV				
	HOSE CONNECTORS VG/VGR				

PRODUCT FAMILY	PRODUCT CATEGORY	PRODUCT NAME	PAGE
NORMA® KITS ASSORTMENTS DISPLAYS TOOLS ACCESSORIES	KITS	NORMAFIX® NORMETTA® Mini repair kits	190
		NORMACLAMP® Quick lock Band-on-roll	190
	ASSORTMENTS	NORMACLAMP® TORRO® Assortment type 120 pcs	191
		NORMACLAMP® COBRA® kit type 500k	191
		NEW: NORMACLAMP® FBS ASSORTMENT	192
		NORMAQUICK® PLAST® Assortment	192
		NORMAPLAST® Assortment type 365 PA 6 and TORRO® W2	193
	DISPLAYS	NORMACLAMP® TORRO® Dispenser	194
		NORMACLAMP® TORRO® Drawer Box	194
		NORMACLAMP® TORRO® Pallet	194
NORMACLAMP® Quick lock Band-on-roll dispenser		194	
NORMA® - MOUNTING TOOLS	MOUNTING TOOLS	NORMACLAMP® TORRO Prepo Assembly fixture	195
		NORMACLAMP® COBRA® Pneumatic pliers	195
		NORMACLAMP® FBS Pneumatic pliers version S	195
		NORMACLAMP® FBS Pneumatic pliers version W	195
		NORMACLAMP® FBS C Multi-release tool	195
		NEW: NORMACONNECT® FGR Mounting aid for REP-E	196
		NORMAFIX® Cable tie pliers for 2.2 to 4.8 mm	196
		NORMAFIX® Cable tie pliers for 4.8 to 7.8 mm	196
		NORMAFIX® Cable tie pliers for 3.6 to 13 mm	196
		NEW: NORMAFIX® Cable tie pliers for 4.7 to 13 mm	196
		NEW: NORMAFIX® Pliers for stainless steel ball locking cable ties from 3.8 to 9 mm	196
		NORMAFIX® NORMETTA® Clamping and cutting tool	196
NORMA® - PLIERS	PLIERS	NORMACLAMP® Earclip pliers	197
		NORMACLAMP® Earclip pliers for flat mounting	197
		NORMACLAMP® COBRA® Hand-held pliers CHT1	197
		NORMACLAMP® COBRA® Hand-held pliers CHT2	197
		NORMACLAMP® FBS Hand-held pliers Type 1	198
		NORMACLAMP® FBS Hand-held pliers Type 2	198
		NEW: NORMAFIX® RSGUV 1 / RSV 1 Handheld pliers	198
NORMA® - SCREWDRIVERS	SCREWDRIVERS	NORMACLAMP® TORRO® Screwdriver SW6, SW7, SW6/7	199
		NORMACLAMP® Hi-torque T-screwdriver	199
		NEW: NORMACLAMP® Tamperproof screwdriver	199
		NORMAFIX® Tube clamp fittings Hexagonal key	199
NORMA® - ACCESSORIES	ACCESSORIES	NORMAFIX® Tube clamp fittings Aluminum End Cap	200
		NORMAFIX® Tube clamp fittings Plastic End Cap	200
		NORMAFIX® Tube clamp fittings Spare Screw	200
		NORMAFIX® Lamppost protection tape	200
		NORMAFIX® Cable tie Wall plug bases for cable tie	201
		NORMAFIX® Cable tie Mounting bases for cable tie	201

KITS



ASSORTMENTS



DISPLAYS



DISPLAYS



MOUNTING TOOLS



MOUNTING TOOLS



SCREWDRIVERS



PLIERS

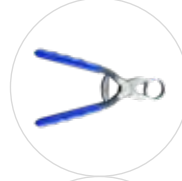

SCREWDRIVERS



ACCESSORIES



PRODUCTS AND APPLICATIONS

		Machine building	White goods	Chemical industry	Irrigation systems	Ship manufacturing
NORMACLAMP®		<ul style="list-style-type: none"> NORMACLAMP® TORRO® NORMACLAMP® HD NORMACLAMP® S/SP NORMACLAMP® GBS NORMACLAMP® SVS NORMACLAMP® COBRA NORMACLAMP® FBS 	<ul style="list-style-type: none"> • • • • • • • 	<ul style="list-style-type: none"> • • • • • • • 	<ul style="list-style-type: none"> • • • • • • • 	<ul style="list-style-type: none"> • • • • • • •
NORMACONNECT®		<ul style="list-style-type: none"> NORMACONNECT® FGR NORMACONNECT® BRS NORMACONNECT® ARS NORMACONNECT® RS/DIN NORMACONNECT® SEC NORMACONNECT® V 	<ul style="list-style-type: none"> • • • • • • 	<ul style="list-style-type: none"> • • • • • • 	<ul style="list-style-type: none"> • • • • • • 	<ul style="list-style-type: none"> • • • • • •
NORMAFIX®		<ul style="list-style-type: none"> NORMAFIX® RS/RSGU NORMAFIX® HMK/K NORMAFIX® NORMETTA® NORMAFIX® CABLE TIE 	<ul style="list-style-type: none"> • • • • 	<ul style="list-style-type: none"> • • • • 	<ul style="list-style-type: none"> • • • • 	<ul style="list-style-type: none"> • • • •
NORMAPLAST®		<ul style="list-style-type: none"> NORMAPLAST® SV 	<ul style="list-style-type: none"> • 	<ul style="list-style-type: none"> • 	<ul style="list-style-type: none"> • 	<ul style="list-style-type: none"> •

	Food and beverage industry	Railway industry	Agricultural machines	Building machines	Engine manufacturing	Pump and filter	Mining industry	Building and site drainage	
	•	• • • • •	• • • • •	• • • • •	• • • • •	• • • • •	• • •	•	NORMACLAMP®
	•	•	• • • •	• • • •	• • • • •	• •	•	•	NORMACONNECT®
	• • •	• • • •	• • • •	• • • •	• • • •	• • • •	• •	•	NORMAFIX®
	•	•	•	•	•	•			NORMAPLAST®



NORMACLAMP® – Hose Clamps



NORMACONNECT® – Pipe Connections



NORMAFIX® – Retaining Products

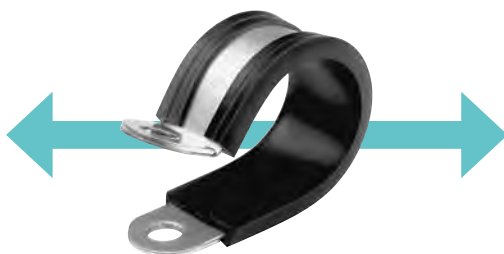

NORMAPLAST® – Hose Connectors**



* Can be designed into a complete system in conjunction with NORMAFLEX® smooth and/or corrugated tube.
 ** Several of the **NORMACLAMP** products can be used.

NORMACLAMP® – Hose Clamps

A comprehensive range to suit diverse applications

Whether you're looking for static hose clamps without springs or dynamic ones with springs, single-range or multi-range clamps, with NORMACLAMP® you'll find the perfect solution for any application.





- 1 Improved asymmetric housing**
– even distribution of forces and safe assembly
- 2 Screw support**
– ease of assembly due to the safe guidance of the emerging band end
- 3 Material and clamping range stamped on the band**
– prevention of errors
- 4 Asymmetric extension**
– prevents the housing from tilting over when the clamp is tightened
- 5 Short housing saddle**
– even contact pressure
- 6 Smooth or stamped inside of band**
– optimal hose protection

Worm drive hose clamps in accordance with DIN 3017

NORMACLAMP® TORRO® multi-range hose clamps are ideally suited to applications with high mechanical loads. Thanks to the continuous developments these products have undergone, they remain the benchmark within modern clamp construction. Within the NORMACLAMP® range, only the TORRO® has its trademark asymmetrical construction.



The asymmetric housing provides high force, superior torque and even distribution of clamping pressure. Clamp aligns perfectly on the hose and ensures the optimal sealing of the connection.

Advantages at a glance

- Multi-range hose clamp
- No chromium(VI) used for coating purposes
- Clamping ranges in acc. with DIN 3017: 8-12 mm to 140-160 mm
- Larger diameters available on request

Applications

- Joining cooling water lines
- Depressurized and pressurized fuel lines and ventilation systems
- Oil lines
- Joining lines in sanitary applications
- Joining lines in machine building applications
- Lines in the household appliance industry
- Hose lines in the commercial vehicle industries

Materials

W1*	W2	W3	W4	W5
x	x	x	x	x

* No chromium(VI) used for the coating on the closure components

Material	Corrosion resistance in salt spray testing
W1	Min. 144 h
W2	Min. 72 h
W3	Min. 200 h*
W4	Min. 400 h
W5	Min. 1000 h

*Max 10% base metal corrosion permissible

Types of clamp band and screw

	W1	W2	W3	W4	W5
Phillips head SW 7*	•	•			
Slotted head SW 7			•	•	•

* Band width 7.5 mm = SW 6

Band width 7.5 mm

- W2, W3 with smooth inside

Band width 9 mm

- W1 with smooth inside
- W2, W3, W4, W5 with stamped inside

Band width 12 mm

- W1, W2, W3 with smooth inside
- W4, W5 with stamped inside

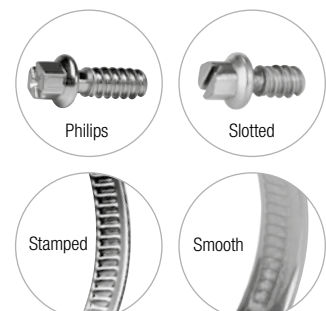

Technical data & Ordering information

NORMACLAMP® TORRO®													
Width	Designation	Clamping ranges		B	h	L	s	S (W1 only)	W1 Product No.	W2 Product No.	W3 Product No.	W4 Product No.	W5 Product No.
		in mm	in inches										
7.5	TORRO 8-12/7.5	8-12	5/16-1/2"	11.5	9	17	0.6			0116 7602 010	0116 7603 010		
	TORRO 10-16/7.5	10-16	3/8-5/8"	11.5	9	17	0.6			0116 7602 013	0116 7603 013		
	TORRO 12-18/7.5	12-18	1/2-11/16"	11.5	9	17	0.6			0116 7602 015	0116 7603 015		
	TORRO 12-22/7.5	12-22	1/2-7/8"	11.5	9	17	0.6			0116 7602 017	0116 7603 017		
	TORRO 16-27/7.5	16-27	5/8-1 1/16"	11.5	9	17	0.6			0116 7602 021	0116 7603 021		
9	TORRO 8-12/9	8-12	5/16-1/2"	13.0	11.0	21.0	0.65	0.8	0126 7565 010	0126 7702 010	0126 7703 010	0126 7704 010	
	TORRO 10-16/9	10-16	5/16-5/8"	13.0	11.0	21.0	0.65	0.8	0126 7565 013	0126 7702 013	0126 7703 013	0126 7704 013	0126 7705 013
	TORRO 12-22/9	12-22	1/2-7/8"	13.0	11.0	24.0	0.65	0.8	0126 7565 017	0126 7702 017	0126 7703 017	0126 7704 017	0126 7705 017
	TORRO 16-27/9	16-27	5/8-1 1/16"	13.0	11.0	24.0	0.65	0.8	0126 7565 021	0126 7702 021	0126 7703 021	0126 7704 021	0126 7705 021
	TORRO 20-32/9	20-32	13/16-1 1/4"	13.0	11.0	24.0	0.65	0.8	0126 7565 026	0126 7702 026	0126 7703 026	0126 7704 026	0126 7705 026
	TORRO 23-35/9	23-35	15/16-1 3/8"	13.0	11.0	24.0	0.65	0.8	0126 7565 029	0126 7702 029	0126 7703 029	0126 7704 029	0126 7705 029
	TORRO 25-40/9	25-40	1-1 9/16"	13.0	11.0	26.0	0.65	0.8	0126 7565 032	0126 7702 032	0126 7703 032	0126 7704 032	0126 7705 032
	TORRO 30-45/9	30-45	1 3/16-1 3/4"	13.0	11.0	26.0	0.65	0.8	0126 7565 037	0126 7702 037	0126 7703 037	0126 7704 037	0126 7705 037
	TORRO 35-50/9 (32-50)	35-50	1 3/8-2"	13.0	11.0	26.0	0.65	0.8	0126 7565 043	0126 7702 041	0126 7703 041	0126 7704 041	0126 7705 041
	TORRO 40-60/9	40-60	1 9/16-2 3/8"	13.0	11.0	26.0	0.65	0.8	0126 7565 050	0126 7702 050	0126 7703 050	0126 7704 050	0126 7705 050
	TORRO 50-70/9	50-70	2-2 3/4"	13.0	11.0	26.0	0.65	0.8	0126 7565 060	0126 7702 060	0126 7703 060	0126 7704 060	0126 7705 060
	TORRO 60-80/9	60-80	2 3/8-3 1/8"	13.0	11.0	26.0	0.65	0.8	0126 7565 070	0126 7702 070	0126 7703 070	0126 7704 070	0126 7705 070
	TORRO 70-90/9	70-90	2 3/4-3 9/16"	13.0	11.0	26.0	0.65	0.8	0126 7565 080	0126 7702 080	0126 7703 080	0126 7704 080	0126 7705 080
	TORRO 80-100/9	80-100	3 1/8-3 15/16"	13.0	11.0	26.0	0.65	0.8	0126 7565 090	0126 7702 090	0126 7703 090	0126 7704 090	0126 7705 090
	TORRO 90-110/9	90-110	3 9/16-4 5/16"	13.0	11.0	26.0	0.65	0.8	0126 7565 100	0126 7702 100	0126 7703 100	0126 7704 100	0126 7705 100
	TORRO 100-120/9	100-120	3 15/16-4 3/4"	13.0	11.0	26.0	0.65	0.8	0126 6565 110	0126 6702 110	0126 6703 110	0126 6704 110	0126 6705 110
	TORRO 110-130/9	110-130	4 5/16-5 1/8"	13.0	11.0	26.0	0.65	0.8	0126 6565 120	0126 6702 120	0126 6703 120	0126 6704 120	0126 6705 120
	TORRO 120-140/9	120-140	4 3/4-5 1/2"	13.0	11.0	26.0	0.65	0.8	0126 6565 130	0126 6702 130	0126 6703 130	0126 6704 130	0126 6705 130
	TORRO 130-150/9	130-150	5 1/8-5 15/16"	13.0	11.0	26.0	0.65	0.8	0126 6565 140	0126 6702 140	0126 6703 140	0126 6704 140	0126 6705 140
TORRO 140-160/9	140-160	5 1/2-6 5/16"	13.0	11.0	26.0	0.65	0.8	0126 6565 150	0126 6702 150	0126 6703 150	0126 6704 150	0126 6705 150	
12	TORRO 16-27/12	16-27	5/8-1 1/16"	14.6	12.5	30.0	0.8	0.8	0136 7352 021	0136 7702 021	0136 7703 021	0136 7704 021	0136 7705 021
	TORRO 20-32/12	20-32	13/16-1 1/4"	14.6	12.5	30.0	0.8	0.8	0136 7352 026	0136 7702 026	0136 7703 026	0136 7704 026	0136 7705 026
	TORRO 23-35/12	23-35	15/16-1 3/8"	14.6	12.5	30.0	0.8	0.8	0136 7352 029	0136 7702 029	0136 7703 029	0136 7704 029	0136 7705 029
	TORRO 25-40/12	25-40	1-1 9/16"	14.6	12.5	30.0	0.8	1.0	0136 7352 032	0136 7702 032	0136 7703 032	0136 7704 032	0136 7705 032
	TORRO 30-45/12	30-45	1 3/16-1 3/4"	14.6	12.5	30.0	0.8	1.0	0136 7352 037	0136 7702 037	0136 7703 037	0136 7704 037	0136 7705 037
	TORRO 35-50/12	35-50	1 3/8-2"	14.6	12.5	30.0	0.8	1.0	0136 7352 043	0136 7702 043	0136 7703 043	0136 7704 043	0136 7705 043
	TORRO 40-60/12	40-60	1 9/16-2 3/8"	14.6	12.5	30.0	0.8	1.0	0136 7352 050	0136 7702 050	0136 7703 050	0136 7704 050	0136 7705 050
	TORRO 50-70/12	50-70	2-2 3/4"	14.6	12.5	30.0	0.8	1.0	0136 7352 060	0136 7702 060	0136 7703 060	0136 7704 060	0136 7705 060
	TORRO 60-80/12	60-80	2 3/8-3 1/8"	14.6	12.5	30.0	0.8	1.0	0136 7352 070	0136 7702 070	0136 7703 070	0136 7704 070	0136 7705 070
	TORRO 70-90/12	70-90	2 3/4-3 9/16"	14.6	12.5	36.0	0.8	1.0	0136 7352 080	0136 7702 080	0136 7703 080	0136 7704 080	0136 7705 080
	TORRO 80-100/12	80-100	3 1/8-3 15/16"	14.6	12.5	36.0	0.8	1.0	0136 7352 090	0136 7702 090	0136 7703 090	0136 7704 090	0136 7705 090
	TORRO 90-110/12	90-110	3 9/16-4 5/16"	14.6	12.5	36.0	0.8	1.0	0136 7352 100	0136 7702 100	0136 7703 100	0136 7704 100	0136 7705 100
	TORRO 100-120/12	100-120	3 15/16-4 3/4"	14.6	12.5	36.0	0.8	1.0	0136 6352 110	0136 6702 110	0136 6703 110	0136 6704 110	0136 6705 110
	TORRO 110-130/12	110-130	4 5/16-5 1/8"	14.6	12.5	36.0	0.8	1.0	0136 6352 120	0136 6702 120	0136 6703 120	0136 6704 120	0136 6705 120
	TORRO 120-140/12	120-140	4 3/4-5 1/2"	14.6	12.5	36.0	0.8	1.0	0136 6352 130	0136 6702 130	0136 6703 130	0136 6704 130	0136 6705 130
TORRO 130-150/12	130-150	5 1/8-5 15/16"	14.6	12.5	36.0	0.8	1.0	0136 6352 140	0136 6702 140	0136 6703 140	0136 6704 140	0136 6705 140	
TORRO 140-160/12	140-160	5 1/2-6 5/16"	14.6	12.5	36.0	0.8	1.0	0136 6352 150	0136 6702 150	0136 6703 150	0136 6704 150	0136 6705 150	

Additional diameters on request (up to 700 mm)



Refer to pages 191, 193, 194 and 199

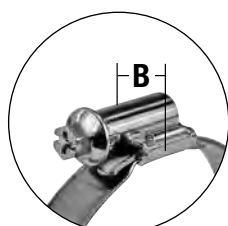

B = overall width
housing

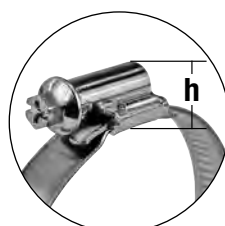

h = overall height
bolt and housing

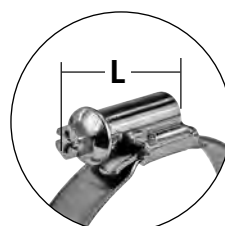

L = overall length
bolt and housing

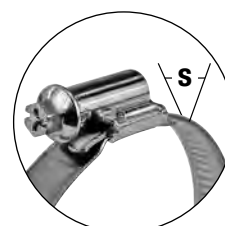

s = band thickness
clamp band

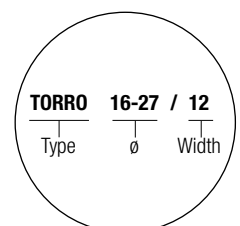

Name structure
clamp band





The TORRO® WF clamp is fitted with a wave spring which automatically re-tensions to ensure optimal radial clamping force. The TORRO® WF is the ideal choice for applications under extreme temperature changes (e.g. charged air), under extremely low temperatures or for the retention of hoses with a tendency of “creeping”/ hose relaxation.

Advantages at a glance

- Automatic re-tensioning effect in the event of hose relaxation
- Increased sealing reliability across a wide temperature range



Materials

W3, W4

NORMACLAMP® TORRO® WF									
Width	Designation	Clamping ranges		B	h	L	s	W3 Product No.	W4 Product No.
		in mm	in inches						
9	TORRO WF 10-16/9	10-16	3/8 - 5/8"	13.0	11.0	21.0	0.65	0127 7708 013	0127 7711 013
	TORRO WF 12-18/9	12-18	1/2-11/16"	13.0	11.0	24.0	0.65	0127 7708 018	0127 7711 015
	TORRO WF 12-20/9	12-20	1/2-13/16"	13.0	11.0	24.0	0.65	0127 7708 016	0127 7711 016
	TORRO WF 12-22/9	12-22	1/2-7/8"	13.0	11.0	24.0	0.65	0127 7708 017	0127 7711 017
	TORRO WF 16-25/9	16-25	5/8-1"	13.0	11.0	24.0	0.65	0127 7708 020	0127 7711 020
	TORRO WF 16-27/9	16-27	5/8-1 1/16"	13.0	11.0	24.0	0.65	0127 7708 021	0127 7711 021
	TORRO WF 20-32/9	20-32	13/16-1 1/4"	13.0	11.0	24.0	0.65	0127 7708 026	0127 7711 026
	TORRO WF 23-35/9	23-35	15/16-1 3/8"	13.0	11.0	24.0	0.65	0127 7708 029	0127 7711 029
	TORRO WF 25-40/9	25-40	1-1 9/16"	13.0	11.0	26.0	0.65	0127 7708 032	0127 7711 032
	TORRO WF 30-45/9	30-45	1 3/16-1 3/4"	13.0	11.0	26.0	0.65	0127 7708 037	0127 7711 037
	TORRO WF 32-50/9	32-50	1 3/8-2"	13.0	11.0	26.0	0.65	0127 7708 041	0127 7711 041
	TORRO WF 40-60/9	40-60	1 9/16-2 3/8"	13.0	11.0	26.0	0.65	0127 7708 050	0127 7711 050
	TORRO WF 45-65/9	45-65	1 3/4-2 9/16"	13.0	11.0	26.0	0.65	0127 7708 055	0127 7711 055
	TORRO WF 50-70/9	50-70	2-2 3/4"	13.0	11.0	26.0	0.65	0127 7708 060	0127 7711 060
	TORRO WF 60-80/9	60-80	2 3/8-3 1/8"	13.0	11.0	26.0	0.65	0127 7708 070	0127 7711 070
	TORRO WF 70-90/9	70-90	2 3/4-3 9/16"	13.0	11.0	26.0	0.65	0127 7708 080	0127 7711 080
	TORRO WF 80-100/9	80-100	3 1/8-3 15/16"	13.0	11.0	26.0	0.65	0127 7708 090	0127 7711 090
TORRO WF 90-110/9	90-110	3 9/16-4 5/16"	13.0	11.0	26.0	0.65	0127 7708 100	0127 7711 100	
TORRO WF 100-120/9	100-120	3 15/16-4 3/4"	13.0	11.0	26.0	0.65	0127 7708 110	0127 7711 110	
TORRO WF 110-130/9	110-130	4 3/8-5 1/8"	13.0	11.0	26.0	0.65	0127 7708 120	0127 7711 120	
12	TORRO WF 16-27/12	16-27	5/8-1 1/16"	14.6	12.5	30.0	0.8	0137 7708 021	0137 7711 021
	TORRO WF 20-32/12	20-32	13/16-1 1/4"	14.6	12.5	30.0	0.8	0137 7708 026	0137 7711 026
	TORRO WF 25-40/12	25-40	1-1 9/16"	14.6	12.5	30.0	0.8	0137 7708 032	0137 7711 032
	TORRO WF 30-45/12	30-45	1 3/16-1 3/4"	14.6	12.5	30.0	0.8	0137 7708 037	0137 7711 037
	TORRO WF 35-50/12	35-50	1 3/8-2"	14.6	12.5	30.0	0.8	0137 7708 043	0137 7711 043
	TORRO WF 40-60/12	40-60	1 9/16-2 3/8"	14.6	12.5	30.0	0.8	0137 7708 050	0137 7711 050
	TORRO WF 50-70/12	50-70	2-2 3/4"	14.6	12.5	30.0	0.8	0137 7708 060	0137 7711 060
	TORRO WF 60-80/12	60-80	2 3/8-3 1/8"	14.6	12.5	30.0	0.8	0137 7708 070	0137 7711 070
	TORRO WF 70-90/12	70-90	2 3/4-3 9/16"	14.6	12.5	36.0	0.8	0137 7708 080	0137 7711 080
	TORRO WF 80-100/12	80-100	3 1/8-3 15/16"	14.6	12.5	36.0	0.8	0137 7708 090	0137 7711 090
TORRO WF 90-110/12	90-110	3 9/16-4 5/16"	14.6	12.5	36.0	0.8	0137 7708 100	0137 7711 100	

Available in W2 on request



Refer to page 199

Table of torques

TORRO 7.5 W2-W3

Diameter	8-12	10-16	12-18	12-22	16-27	20-32	25-40	30-45	35-50	40-60
TT	max 1.5	max 1.5	max 1.5	max 1.5	max 1.5					
FRT max										

TORRO 9 W1

Diameter	8-12	10-16	12-18	12-22	16-27	20-32	25-40	30-45	35-50	40-60
TT	2.5 +0.5	3 +0.5	3 +0.5	3 +0.5	3 +0.5	3 +0.5	3 +0.5	3 +0.5	3 +0.5	3 +0.5
FRT max	1.2	1.2	1.2	1.2	1.2	1.2	1.2	1.2	1.2	1.2

Diameter	50-70	60-80	70-90	80-100	90-110	100-120	110-130	120-140	130-150	140-160
TT	3 +0.5	3 +0.5	3 +0.5	3 +0.5	3 +0.5	3 +0.5	3 +0.5	3 +0.5	3 +0.5	3 +0.5
FRT max	1.2	1.2	1.2	1.2	1.2	1.2	1.2	1.2	1.2	1.2

TORRO 9 W2

Diameter	8-12	10-16	12-18	12-22	16-27	20-32	25-40	30-45	35-50	40-60
TT		2 +0.5		3 +0.5	3 +0.5	3 +0.5	3 +0.5	3 +0.5	3 +0.5	3 +0.5
FRT max		0.7		0.7	0.7	0.7	0.7	0.7	0.7	0.7

Diameter	50-70	60-80	70-90	80-100	90-110	100-120	110-130	120-140	130-150	140-160
TT	3 +0.5	3 +0.5	3 +0.5	3 +0.5	3 +0.5	3 +0.5	3 +0.5	3 +0.5	3 +0.5	3 +0.5
FRT max	0.7	0.7	0.7	0.7	0.7	0.7	0.7	0.7	0.7	0.7

TORRO 9 W3-W5

Diameter	8-12	10-16	12-18	12-22	16-27	20-32	25-40	30-45	35-50	40-60
TT		2 +0.5		3 +0.5	3 +0.5	3 +0.5	3 +0.5	3 +0.5	3 +0.5	3 +0.5
FRT max		0.7		0.7	0.7	0.7	0.7	0.7	0.7	0.7

Diameter	50-70	60-80	70-90	80-100	90-110	100-120	110-130	120-140	130-150	140-160
TT	3 +0.5	3 +0.5	3 +0.5	3 +0.5	3 +0.5	3 +0.5	3 +0.5	3 +0.5	3 +0.5	3 +0.5
FRT max	0.7	0.7	0.7	0.7	0.7	0.7	0.7	0.7	0.7	0.7

TORRO 12 W1

Diameter	8-12	10-16	12-18	12-22	16-27	20-32	25-40	30-45	35-50	40-60
TT					5 +0.5	5 +0.5	5 +0.5	5 +0.5	5 +0.5	5 +0.5
FRT max					1.2	1.2	1.2	1.2	1.2	1.2

Diameter	50-70	60-80	70-90	80-100	90-110	100-120	110-130	120-140	130-150	140-160
TT	5 +0.5	5 +0.5	5 +0.5	5 +0.5	5 +0.5	5 +0.5	5 +0.5	5 +0.5	5 +0.5	5 +0.5
FRT max	1.2	1.2	1.2	1.2	1.2	1.2	1.2	1.2	1.2	1.2

TORRO 12 W2/W3

Diameter	8-12	10-16	12-18	12-22	16-27	20-32	25-40	30-45	35-50	40-60
TT					5 +0.5	5 +0.5	5 +0.5	5 +0.5	5 +0.5	5 +0.5
LD max					1	1	1	1	1	1

Diameter	50-70	60-80	70-90	80-100	90-110	100-120	110-130	120-140	130-150	140-160
TT	5 +0.5	5 +0.5	5 +0.5	5 +0.5	5 +0.5	5 +0.5	5 +0.5	5 +0.5	5 +0.5	5 +0.5
FRT max	1	1	1	1	1	1	1	1	1	1

TORRO 12 W4/W5

Diameter	8-12	10-16	12-18	12-22	16-27	20-32	25-40	30-45	35-50	40-60
TT					5 +0.5	5 +0.5	5 +0.5	5 +0.5	5 +0.5	5 +0.5
FRT max					1	1	1	1	1	1

Diameter	50-70	60-80	70-90	80-100	90-110	100-120	110-130	120-140	130-150	140-160
TT	5 +0.5	5 +0.5	5 +0.5	5 +0.5	5 +0.5	5 +0.5	5 +0.5	5 +0.5	5 +0.5	5 +0.5
FRT max	1	1	1	1	1	1	1	1	1	1

TT = Tightening Torque

FRT = Free Running Torque



The torque cap shears off when the permissible tightening torque is reached, thus saving the need to use a torque wrench. The bolt slot can still be accessed even after the break-off point, meaning that the clamp can be removed and/or re-tensioned if necessary.

Advantages at a glance

- Defined tightening torque without the need for special tools
- Installation can be checked visually

Materials

W1, W2, W3, W4

NORMACLAMP® TORRO® WITH TORQUE CAP												
Width	Designation	Clamping ranges		B	h	L	s	S (W1 only)	W1 Product No.	W2 Product No.	W3 Product No.	W4 Product No.
		in mm	in inches									
9	TORRO TORQUE CAP 8-12/9	8-12	5/16-1/2"	13.0	11.0	27.0	0.65	0.8	0126 7562 010	0126 7516 010	0126 7432 010	0126 7490 010
	TORRO TORQUE CAP 8-16/9	8-16	5/16-5/8"	13.0	11.0	27.0	0.65	0.8	0126 7562 013	0126 7516 013	0126 7432 013	0126 7490 013
	TORRO TORQUE CAP 12-22/9	12-22	1/2-7/8"	13.0	11.0	30.0	0.65	0.8	0126 7562 017	0126 7516 017	0126 7432 017	0126 7490 017
	TORRO TORQUE CAP 16-27/9	16-27	5/8-1 1/16"	13.0	11.0	30.0	0.65	0.8	0126 7562 021	0126 7516 021	0126 7432 021	0126 7490 021
	TORRO TORQUE CAP 20-32/9	20-32	13/16-1 1/4"	13.0	11.0	30.0	0.65	0.8	0126 7562 026	0126 7516 026	0126 7432 026	0126 7490 026
	TORRO TORQUE CAP 23-35/9	23-35	15/16-1 3/8"	13.0	11.0	30.0	0.65	0.8	0126 7562 029	0126 7516 029	0126 7432 029	0126 7490 029
	TORRO TORQUE CAP 25-40/9	25-40	1-1 9/16"	13.0	11.0	32.0	0.65	0.8	0126 7562 032	0126 7516 032	0126 7432 032	0126 7490 032
	TORRO TORQUE CAP 30-45/9	30-45	1 3/16-1 3/4"	13.0	11.0	32.0	0.65	0.8	0126 7562 037	0126 7516 037	0126 7432 037	0126 7490 037
	TORRO TORQUE CAP 35-50/9 (32 - 50)	35-50	1 3/8-2"	13.0	11.0	32.0	0.65	0.8	0126 7562 043	0126 7516 041	0126 7432 041	0126 7490 041
	TORRO TORQUE CAP 40-60/9	40-60	1 9/16-2 3/8"	13.0	11.0	32.0	0.65	0.8	0126 7562 050	0126 7516 050	0126 7432 050	0126 7490 050
	TORRO TORQUE CAP 50-70/9	50-70	2-2 3/4"	13.0	11.0	32.0	0.65	0.8	0126 7562 060	0126 7516 060	0126 7432 060	0126 7490 060
	TORRO TORQUE CAP 60-80/9	60-80	2 3/8-3 1/8"	13.0	11.0	32.0	0.65	0.8	0126 7562 070	0126 7516 070	0126 7432 070	0126 7490 070
	TORRO TORQUE CAP 70-90/9	70-90	2 3/4-3 9/16"	13.0	11.0	32.0	0.65	0.8	0126 7562 080	0126 7516 080	0126 7432 080	0126 7490 080
	TORRO TORQUE CAP 80-100/9	80-100	3 1/8-3 15/16"	13.0	11.0	32.0	0.65	0.8	0126 7562 090	0126 7516 090	0126 7432 090	0126 7490 090
	TORRO TORQUE CAP 90-110/9	90-110	3 9/16-4 5/16"	13.0	11.0	32.0	0.65	0.8	0126 7562 100	0126 7516 100	0126 7432 100	0126 7490 100
	TORRO TORQUE CAP 100-120/9	100-120	3 15/16-4 5/16"	13.0	11.0	32.0	0.65	0.8	0126 6562 110	0126 6516 110	0126 6432 110	0126 6490 110
	TORRO TORQUE CAP 110-130/9	110-130	4 5/16-5 1/8"	13.0	11.0	32.0	0.65	0.8	0126 6562 120	0126 6516 120	0126 6432 120	0126 6490 120
TORRO TORQUE CAP 120-140/9	120-140	4 3/4-5 1/2"	13.0	11.0	32.0	0.65	0.8	0126 6562 130	0126 6516 130	0126 6432 130	0126 6490 130	
TORRO TORQUE CAP 130-150/9	130-150	5 1/8-5 15/16"	13.0	11.0	32.0	0.65	0.8	0126 6562 140	0126 6516 140	0126 6432 140	0126 6490 140	
TORRO TORQUE CAP 140-160/9	140-160	5 1/2-6 5/16"	13.0	11.0	32.0	0.65	0.8	0126 6562 150	0126 6516 150	0126 6432 150	0126 6490 150	
12	TORRO TORQUE CAP 16-27/12	16-27	5/8-1 1/16"	14.6	12.5	36.0	0.8	0.8	0136 7135 021		0136 7181 021	
	TORRO TORQUE CAP 20-32/12	20-32	13/16-1 1/4"	14.6	12.5	36.0	0.8	0.8	0136 7135 026		0136 7181 026	
	TORRO TORQUE CAP 23-35/12	23-35	15/16-1 3/8"	14.6	12.5	36.0	0.8	0.8	0136 7135 029		0136 7181 029	
	TORRO TORQUE CAP 25-40/12	25-40	1-1 9/16"	14.6	12.5	36.0	1.0	1.0	0136 7135 032		0136 7181 032	
	TORRO TORQUE CAP 30-45/12	30-45	1 3/16-1 3/4"	14.6	12.5	36.0	1.0	1.0	0136 7135 037		0136 7181 037	
	TORRO TORQUE CAP 35-50/12	35-50	1 3/8-2"	14.6	12.5	36.0	1.0	1.0	0136 7135 043		0136 7181 043	
	TORRO TORQUE CAP 40-60/12	40-60	1 9/16-2 3/8"	14.6	12.5	36.0	1.0	1.0	0136 7135 050		0136 7181 050	
	TORRO TORQUE CAP 50-70/12	50-70	2-2 3/4"	14.6	12.5	36.0	1.0	1.0	0136 7135 060		0136 7181 060	
	TORRO TORQUE CAP 60-80/12	60-80	2 3/8-3 1/8"	14.6	12.5	36.0	1.0	1.0	0136 7135 070		0136 7181 070	
	TORRO TORQUE CAP 70-90/12	70-90	2 3/4-3 9/16"	14.6	12.5	42.0	1.0	1.0	0136 7135 080		0136 7181 080	
	TORRO TORQUE CAP 80-100/12	80-100	3 1/8-3 15/16"	14.6	12.5	42.0	1.0	1.0	0136 7135 090		0136 7181 090	
	TORRO TORQUE CAP 90-110/12	90-110	3 9/16-4 5/16"	14.6	12.5	42.0	1.0	1.0	0136 7135 100		0136 7181 100	
	TORRO TORQUE CAP 100-120/12	100-120	3 15/16-4 3/4"	14.6	12.5	42.0	1.0	1.0	0136 6135 110		0136 6181 110	
	TORRO TORQUE CAP 110-130/12	110-130	4 5/16-5 1/8"	14.6	12.5	42.0	1.0	1.0	0136 6135 120		0136 6181 120	
	TORRO TORQUE CAP 120-140/12	120-140	4 3/4-5 1/2"	14.6	12.5	42.0	1.0	1.0	0136 6135 130		0136 6181 130	
	TORRO TORQUE CAP 130-150/12	130-150	5 1/8-5 15/16"	14.6	12.5	42.0	1.0	1.0	0136 6135 140		0136 6181 140	
	TORRO TORQUE CAP 140-160/12	140-160	5 1/2-6 5/16"	14.6	12.5	42.0	1.0	1.0	0136 6135 150		0136 6181 150	



The NORMACLAMP® TORRO® Thumb screw can be comfortably tightened by hand using the wide screw head.

Main advantage

The clamp can be tightened or opened manually

Materials

W1, W2, W3, W4, W5

NORMACLAMP® TORRO® THUMB SCREW														
Width	Designation	Clamping ranges		B	h	L	s	s (W1 only)	W1 Product No.	W2 Product No.	W3 Product No.	W4 Product No.	W5 Product No.	
		in mm	in inches											
9	TORRO THUMB SCREW 8-12/9	8-12	5/16-1/2"	13.0	11.0	21.0	0.65	0.8	0126 7269 010					
	TORRO THUMB SCREW 8-16/9	8-16	5/16-5/8"	13.0	11.0	21.0	0.65	0.8	0126 7269 013	0126 7270 013	0126 7271 013	0126 7272 013		
	TORRO THUMB SCREW 12-22/9	12-22	1/2-7/8"	13.0	11.0	24.0	0.65	0.8	0126 7269 017	0126 7270 017	0126 7271 017	0126 7272 017		
	TORRO THUMB SCREW 16-27/9	16-27	5/8-1 1/16"	13.0	11.0	24.0	0.65	0.8	0126 7269 021	0126 7270 021	0126 7271 021	0126 7272 021		
	TORRO THUMB SCREW 20-32/9	20-32	13/16-1 1/4"	13.0	11.0	24.0	0.65	0.8	0126 7269 026	0126 7270 026	0126 7271 026	0126 7272 026		
	TORRO THUMB SCREW 23-35/9	23-35	15/16-1 3/8"	13.0	11.0	24.0	0.65	0.8	0126 7269 029	0126 7270 029	0126 7271 029	0126 7272 029		
	TORRO THUMB SCREW 25-40/9	25-40	1-1 9/16"	13.0	11.0	26.0	0.65	0.8	0126 7269 032	0126 7270 032	0126 7271 032	0126 7272 032		
	TORRO THUMB SCREW 30-45/9	30-45	1 3/16-1 3/4"	13.0	11.0	26.0	0.65	0.8	0126 7269 037	0126 7270 037	0126 7271 037	0126 7272 037		
	TORRO THUMB SCREW 35-50/9 (32-50)	35-50	1 3/8-2"	13.0	11.0	26.0	0.65	0.8	0126 7269 043	0126 7270 041	0126 7271 041	0126 7272 041		
	TORRO THUMB SCREW 40-60/9	40-60	1 9/16-2 3/8"	13.0	11.0	26.0	0.65	0.8	0126 7269 050	0126 7270 050	0126 7271 050	0126 7272 050		
	TORRO THUMB SCREW 50-70/9	50-70	2-2 3/4"	13.0	11.0	26.0	0.65	0.8	0126 7269 060	0126 7270 060	0126 7271 060	0126 7272 060		
	TORRO THUMB SCREW 60-80/9	60-80	2 3/8-3 1/8"	13.0	11.0	26.0	0.65	0.8	0126 7269 070	0126 7270 070	0126 7271 070	0126 7272 070		
	TORRO THUMB SCREW 70-90/9	70-90	2 3/4-3 9/16"	13.0	11.0	26.0	0.65	0.8	0126 7269 080	0126 7270 080	0126 7271 080	0126 7272 080		
TORRO THUMB SCREW 80-100/9	80-100	3 1/8-3 15/16"	13.0	11.0	26.0	0.65	0.8	0126 7269 090	0126 7270 090	0126 7271 090	0126 7272 090			
TORRO THUMB SCREW 90-110/9	90-110	3 9/16-4 5/16"	13.0	11.0	26.0	0.65	0.8	0126 7269 100	0126 7270 100	0126 7271 100	0126 7272 100			
12	TORRO THUMB SCREW 16-27/12	16-27	5/8-1 1/16"	14.6	12.5	30.0	0.8	0.8	0136 7308 021	0136 7309 021	0136 7310 021	0136 7311 021	0136 7312 021	
	TORRO THUMB SCREW 20-32/12	20-32	13/16-1 1/4"	14.6	12.5	30.0	0.8	0.8	0136 7308 026	0136 7309 026	0136 7310 026	0136 7311 026	0136 7312 026	
	TORRO THUMB SCREW 23-35/12	23-35	15/16-1 3/8"	14.6	12.5	30.0	0.8	0.8	0136 7308 029	0136 7309 029	0136 7310 029	0136 7311 029	0136 7312 029	
	TORRO THUMB SCREW 25-40/12	25-40	1-1 9/16"	14.6	12.5	30.0	0.8	1.0	0136 7308 032	0136 7309 032	0136 7310 032	0136 7311 032	0136 7312 032	
	TORRO THUMB SCREW 30-45/12	30-45	1 3/16-1 3/4"	14.6	12.5	30.0	0.8	1.0	0136 7308 037	0136 7309 037	0136 7310 037	0136 7311 037	0136 7312 037	
	TORRO THUMB SCREW 35-50/12	35-50	1 3/8-2"	14.6	12.5	30.0	0.8	1.0	0136 7308 043	0136 7309 043	0136 7310 043	0136 7311 043	0136 7312 043	
	TORRO THUMB SCREW 45-55/12	45-55	1 3/4-2 3/16"	14.6	12.5	30.0	0.8	1.0	0136 7308 048	0136 7309 048	0136 7310 048	0136 7311 048	0136 7312 048	
	TORRO THUMB SCREW 40-60/12	40-60	1 9/16-2 3/8"	14.6	12.5	30.0	0.8	1.0	0136 7308 050	0136 7309 050	0136 7310 050	0136 7311 050	0136 7312 050	
	TORRO THUMB SCREW 45-65/12	45-65	1 3/4-2 9/16"	14.6	12.5	30.0	0.8	1.0	0136 7308 055	0136 7309 055	0136 7310 055	0136 7311 055	0136 7312 055	
	TORRO THUMB SCREW 50-70/12	50-70	2-2 3/4"	14.6	12.5	30.0	0.8	1.0	0136 7308 060	0136 7309 060	0136 7310 060	0136 7311 060	0136 7312 060	
	TORRO THUMB SCREW 55-75/12	55-75	2 3/16-2 15/16"	14.6	12.5	30.0	0.8	1.0	0136 7308 065	0136 7309 065	0136 7310 065	0136 7311 065	0136 7312 065	
	TORRO THUMB SCREW 60-80/12	60-80	2 3/8-3 1/8"	14.6	12.5	30.0	0.8	1.0	0136 7308 070	0136 7309 070	0136 7310 070	0136 7311 070	0136 7312 070	
	TORRO THUMB SCREW 65-85/12	65-85	2 9/16-3 3/8"	14.6	12.5	30.0	0.8	1.0	0136 7308 075	0136 7309 075	0136 7310 075	0136 7311 075	0136 7312 075	
	TORRO THUMB SCREW 70-90/12	70-90	2 3/4-3 9/16"	14.6	12.5	36.0	0.8	1.0	0136 7308 080	0136 7309 080	0136 7310 080	0136 7311 080	0136 7312 080	
	TORRO THUMB SCREW 75-95/12	75-95	2 15/16-3 3/4"	14.6	12.5	36.0	0.8	1.0	0136 7308 085	0136 7309 085	0136 7310 085	0136 7311 085	0136 7312 085	
	TORRO THUMB SCREW 80-100/12	80-100	3 1/8-3 15/16"	14.6	12.5	36.0	0.8	1.0	0136 7308 090	0136 7309 090	0136 7310 090	0136 7311 090	0136 7312 090	
	TORRO THUMB SCREW 90-110/12	90-110	3 9/16-4 5/16"	14.6	12.5	36.0	0.8	1.0	0136 7308 100	0136 7309 100	0136 7310 100	0136 7311 100	0136 7312 100	
	TORRO THUMB SCREW 100-120/12	100-120	3 15/16-4 3/4"	14.6	12.5	36.0	0.8	1.0	0136 7308 110	0136 7309 110	0136 7310 110	0136 7311 110	0136 7312 110	
	TORRO THUMB SCREW 110-130/12	110-130	4 5/16-5 1/8"	14.6	12.5	36.0	0.8	1.0	0136 7308 120	0136 7309 120	0136 7310 120	0136 7311 120	0136 7312 120	
	TORRO THUMB SCREW 120-140/12	120-140	4 3/4-5 1/2"	14.6	12.5	36.0	0.8	1.0	0136 7308 130	0136 7309 130	0136 7310 130	0136 7311 130	0136 7312 130	
	TORRO THUMB SCREW 130-150/12	130-150	5 1/8-5 15/16"	14.6	12.5	36.0	0.8	1.0	0136 7308 140	0136 7309 140	0136 7310 140	0136 7311 140	0136 7312 140	
TORRO THUMB SCREW 140-160/12	140-160	5 1/2-6 5/16"	14.6	12.5	36.0	0.8	1.0	0136 7308 150	0136 7309 150	0136 7310 150	0136 7311 150	0136 7312 150		
TORRO THUMB SCREW 150-170/12	150-170	5 15/16-6 11/16"	14.6	12.5	36.0	0.8	1.0	0136 7308 160	0136 7309 160	0136 7310 160	0136 7311 160	0136 7312 160		
TORRO THUMB SCREW 160-180/12	160-180	6 5/16-7 1/16"	14.6	12.5	36.0	0.8	1.0	0136 7308 170	0136 7309 170	0136 7310 170	0136 7311 170	0136 7312 170		



The NORMACLAMP® TORRO® Tamperproof can only be mounted and dismantled by using the Tamperproof Screwdriver – details on page 199. The specially designed screw head has three radial grooves, which means it cannot be adjusted with any commercially available tools. Automated assembly using a torque gun is particularly effective, as the special shape of the screw head allows for minimal misalignment or offset.

Main advantage

Non-dismountable clamps protect against manipulation

Materials

W3, W4



Refer to page 199



NORMACLAMP® TORRO® TAMPERPROOF									
Width	Designation	Clamping ranges		B	h	L	s	W3 Product No.	W4 Product No.
		mm	inches						
9	TORRO TAMPERPROOF 8-12/9	8-12	5/16-1/2"	13.0	11.0	21.0	0.65	0126 6468 010	0126 6469 010
	TORRO TAMPERPROOF 8-16/9	8-16	5/16-5/8"	13.0	11.0	21.0	0.65	0126 6468 013	0126 6469 013
	TORRO TAMPERPROOF 12-20/9	12-20	1/2-13/16"	13.0	11.0	24.0	0.65	0126 6468 016	0126 6469 016
	TORRO TAMPERPROOF 12-22/9	12-22	1/2-7/8"	13.0	11.0	24.0	0.65	0126 6468 017	0126 6469 017
	TORRO TAMPERPROOF 16-25/9	16-25	5/8-1"	13.0	11.0	24.0	0.65	0126 6468 020	0126 6469 020
	TORRO TAMPERPROOF 16-27/9	16-27	5/8-1 1/16"	13.0	11.0	24.0	0.65	0126 6468 021	0126 6469 021
	TORRO TAMPERPROOF 20-32/9	20-32	13/16-1 1/4"	13.0	11.0	24.0	0.65	0126 6468 026	0126 6469 026
	TORRO TAMPERPROOF 23-35/9	23-35	15/16-1 3/8"	13.0	11.0	24.0	0.65	0126 6468 029	0126 6469 029
	TORRO TAMPERPROOF 25-40/9	25-40	1-1 9/16"	13.0	11.0	26.0	0.65	0126 6468 032	0126 6469 032
	TORRO TAMPERPROOF 30-45/9	30-45	1 3/16-1 3/4"	13.0	11.0	26.0	0.65	0126 6468 037	0126 6469 037
	TORRO TAMPERPROOF 32-50/9	32-50	1 1/4-2"	13.0	11.0	26.0	0.65	0126 6468 041	0126 6469 041
	TORRO TAMPERPROOF 35-55/9	35-55	1 3/8-2 3/16"	13.0	11.0	26.0	0.65	0126 6468 045	0126 6469 045
	TORRO TAMPERPROOF 40-60/9	40-60	1 9/16-2 3/8"	13.0	11.0	26.0	0.65	0126 6468 050	0126 6469 050
	TORRO TAMPERPROOF 45-65/9	45-65	1 3/4-2 9/16"	13.0	11.0	26.0	0.65	0126 6468 055	0126 6469 055
	TORRO TAMPERPROOF 50-70/9	50-70	2-2 3/4"	13.0	11.0	26.0	0.65	0126 6468 060	0126 6469 060
	TORRO TAMPERPROOF 55-75/9	55-75	2 3/16-2 15/16"	13.0	11.0	26.0	0.65	0126 6468 065	0126 6469 065
	TORRO TAMPERPROOF 60-80/9	60-80	2 3/8-3 1/8"	13.0	11.0	26.0	0.65	0126 6468 070	0126 6469 070
	TORRO TAMPERPROOF 65-85/9	65-85	2 9/16-3 3/8"	13.0	11.0	26.0	0.65	0126 6468 075	0126 6469 075
	TORRO TAMPERPROOF 70-90/9	70-90	2 3/4-3 9/16"	13.0	11.0	26.0	0.65	0126 6468 080	0126 6469 080
	TORRO TAMPERPROOF 75-95/9	75-95	2 15/16-3 3/4"	13.0	11.0	26.0	0.65	0126 6468 085	0126 6469 085
TORRO TAMPERPROOF 80-100/9	80-100	3 1/8-3 15/16"	13.0	11.0	26.0	0.65	0126 6468 090	0126 6469 090	
TORRO TAMPERPROOF 90-110/9	90-110	3 9/16-4 5/16"	13.0	11.0	26.0	0.65	0126 6468 100	0126 6469 100	
TORRO TAMPERPROOF 100-120/9	100-120	3 15/16-4 3/4"	13.0	11.0	26.0	0.65	0126 6468 110	0126 6469 110	
TORRO TAMPERPROOF 110-130/9	110-130	4 5/16-5 1/8"	13.0	11.0	26.0	0.65	0126 6468 120	0126 6469 120	
TORRO TAMPERPROOF 120-140/9	120-140	4 3/4-5 1/2"	13.0	11.0	26.0	0.65	0126 6468 130	0126 6469 130	
TORRO TAMPERPROOF 130-150/9	130-150	5 1/8-5 15/16"	13.0	11.0	26.0	0.65	0126 6468 140	0126 6469 140	
TORRO TAMPERPROOF 140-160/9	140-160	5 1/2-6 5/16"	13.0	11.0	26.0	0.65	0126 6468 150	0126 6469 150	
12	TORRO TAMPERPROOF 16-27/12	16-27	5/8-1 1/16"	14.6	12.5	30.0	0.8	0136 6358 021	0136 6359 021
	TORRO TAMPERPROOF 20-32/12	20-32	13/16-1 1/4"	14.6	12.5	30.0	0.8	0136 6358 026	0136 6359 026
	TORRO TAMPERPROOF 23-35/12	23-35	15/16-1 3/8"	14.6	12.5	30.0	0.8	0136 6358 029	0136 6359 029
	TORRO TAMPERPROOF 25-40/12	25-40	1-1 9/16"	14.6	12.5	30.0	0.8	0136 6358 032	0136 6359 032
	TORRO TAMPERPROOF 30-45/12	30-45	1 3/16-1 3/4"	14.6	12.5	30.0	0.8	0136 6358 037	0136 6359 037
	TORRO TAMPERPROOF 35-50/12	35-50	1 3/8-2"	14.6	12.5	30.0	0.8	0136 6358 043	0136 6359 043
	TORRO TAMPERPROOF 40-55/12	40-55	1 9/16-2 3/16"	14.6	12.5	30.0	0.8	0136 6358 048	0136 6359 048
	TORRO TAMPERPROOF 40-60/12	40-60	1 9/16-2 3/8"	14.6	12.5	30.0	0.8	0136 6358 050	0136 6359 050
	TORRO TAMPERPROOF 45-65/12	45-65	1 3/4-2 9/16"	14.6	12.5	30.0	0.8	0136 6358 055	0136 6359 055
	TORRO TAMPERPROOF 50-70/12	50-70	2-2 3/4"	14.6	12.5	30.0	0.8	0136 6358 060	0136 6359 060
	TORRO TAMPERPROOF 55-75/12	55-75	2 3/16-2 15/16"	14.6	12.5	30.0	0.8	0136 6358 065	0136 6359 065
	TORRO TAMPERPROOF 60-80/12	60-80	2 3/8-3 1/8"	14.6	12.5	30.0	0.8	0136 6358 070	0136 6359 070
	TORRO TAMPERPROOF 65-85/12	65-85	2 9/16-3 3/8"	14.6	12.5	30.0	0.8	0136 6358 075	0136 6359 075
	TORRO TAMPERPROOF 70-90/12	70-90	2 3/4-3 9/16"	14.6	12.5	36.0	0.8	0136 6358 080	0136 6359 080
	TORRO TAMPERPROOF 75-95/12	75-95	2 15/16-3 3/4"	14.6	12.5	36.0	0.8	0136 6358 085	0136 6359 085
	TORRO TAMPERPROOF 80-100/12	80-100	3 1/8-3 15/16"	14.6	12.5	36.0	0.8	0136 6358 090	0136 6359 090
	TORRO TAMPERPROOF 90-110/12	90-110	3 9/16-4 5/16"	14.6	12.5	36.0	0.8	0136 6358 100	0136 6359 100
	TORRO TAMPERPROOF 100-120/12	100-120	3 15/16-4 3/4"	14.6	12.5	36.0	0.8	0136 6358 110	0136 6359 110
	TORRO TAMPERPROOF 110-130/12	110-130	4 5/16-5 1/8"	14.6	12.5	36.0	0.8	0136 6358 120	0136 6359 120
	TORRO TAMPERPROOF 120-140/12	120-140	4 3/4-5 1/2"	14.6	12.5	36.0	0.8	0136 6358 130	0136 6359 130
TORRO TAMPERPROOF 130-150/12	130-150	5 1/8-5 15/16"	14.6	12.5	36.0	0.8	0136 6358 140	0136 6359 140	
TORRO TAMPERPROOF 140-160/12	140-160	5 1/2-6 5/16"	14.6	12.5	36.0	0.8	0136 6358 150	0136 6359 150	

Notch



The notch is a clever means of pre-positioning the TORRO® hose clip on the hose. In this case the oval hole in the clamp band finds its exact counterpart on the hose surface. Thus the TORRO® is safely and accurately kept in place prior to the final assembly. Available in band widths of 9 and 12 mm and different angles on request.

Main advantage

Safe pre-assembly on rubber sleeves and molded pipes

Material

W3



Refer to page 199

Prefix system



The NORMACLAMP® TORRO® Prefix system is a concept for integrated clamps and clips on hoses and pipes. Demand for complete systems that include the appropriate sealing function is increasing. This system can only be fixed by using a special tool. Available in band widths of 9 and 12 mm on request.

Advantages at a glance

- Safe pre-assembly on hoses and molded pipes
- Two versions, left- and right-handed. Works on silicone and rubber hoses

Materials

W3, W4



Refer to page 195

WF Prefix system



The NORMACLAMP® TORRO® WF Prefix system is the combination of the NORMACLAMP® TORRO® WF and the NORMACLAMP® Prefix system. This system can only be fixed by using a special tool. Available in 9 and 12 mm band widths on request.

Advantages at a glance

- Axial and radial adjustment of the clamp
- Possible for multilayer hoses and blow molded pipes
- Already available in series for different hose thickness
- Clinch design
- Eliminates corrosion issues
- Two versions, left- and right-handed
- Works on silicone and rubber hoses

Materials

W3, W4



Refer to page 195

Prefix clip



With this feature the TORRO® can also be pre-positioned on the hose. The two 'teeth' of this device keep the TORRO® hose clip safely in place if it needs to be stocked or transported prior to its final assembly. Available in band widths of 9 and 12 mm on request.

Advantages at a glance

- Safe pre-assembly on the hose
- Two versions, left- and right-handed

Materials

W3, W4



Refer to page 199

Prefix Double clip



With this feature the TORRO® can also be pre-positioned on the hose. The 'teeth' of the clips keep the TORRO® hose clip safely in place if it needs to be stocked or transported prior to its final assembly. Available for the TORRO® with band width 12 mm.



Advantages at a glance

- Safe pre-assembly on the hose
- Two versions, left- and right-handed

Materials

W3, W4



Refer to page 199

Radial insert



Compared to standard worm drive hose clamps, the Radial Insert is a "Spring Clamp", which offers optimal contraction and expansion capabilities. It is suitable for all applications where the hose is exposed to temperature fluctuations. The special design ensures a reliable seal throughout the complete thermal cycle. Available for the TORRO® with band width 9 mm.

Advantages at a glance

- The internal sliding sleeve optimizes clamping pressure
- High contact pressure due to the radially corrugated design
- Compensates for temperature fluctuations

Material

W1



Refer to page 199

Safety collar



The NORMACLAMP® TORRO® safety collar 9/12 - 1043 0000 364 is a plastic ring that can be attached easily to the screw head of the clamp. By preventing the screwdriver from slipping off the head, it makes the installation process considerably safer. The safety collar is available for screws that correspond to wrench opening 7.

Main advantage

Screwdriver prevented from slipping during installation

Materials

For all materials

Safety cap



The NORMACLAMP® TORRO® safety cap is a small plastic cap which covers the end of the clamp band, thus stopping injuries from occurring and making a significant contribution to accident prevention measures.

Main advantage

Available for band widths 7.5 mm - 0045 8000 021, 9 mm - 0045 8000 022 and 12 mm - 0045 8000 023

Material

Plastic



- 1 **Extended bridge**
- 2 **16 mm band width**
– for applications where harsh torques and contact pressures are required
- 3 **Clamping range stamped on the band**
– prevention of errors

Worm drive hose clamps

NORMACLAMP® HD is suitable for special applications where harsh torques and contact pressures are required. This clamp is an add-on type to our range of worm drive hose clips and therefore only available in 16 mm band width and W4 material quality.

Main advantage

The extended bridge prevents leaks and hose being damaged

Applications

Mounting of silicone, plastic and rubber tubing with steel inserts

Materials

Material	Corrosion resistance in salt spray testing
W4	Min. 240 h*

* Max 5% corrosion of the base material allowed

Torques

Band width	Failure torque (min. value)	Recommended tightening torque
16	17 Nm	max. 10 Nm*

* Depending on the type of application

Technical data & Ordering information

NORMACLAMP® HD								
Width	Designation	Clamping ranges		B	h	L	s	W4 Product No.
		in mm	in inches					
16	HD 25-45/16 C8	25-45	1-1 3/4"	23.0	13.0	37.0	0.7	0156 7804 035
	HD 32-54/16 C8	32-54	1 1/4-2 1/8"	23.0	13.0	37.0	0.7	0156 7804 043
	HD 45-67/16 C8	45-67	1 3/4-2 5/8"	23.0	13.0	37.0	0.7	0156 7804 056
	HD 57-79/16 C8	57-79	2 1/4-3 1/8"	23.0	13.0	37.0	0.7	0156 7804 068
	HD 70-92/16 C8	70-92	2 3/4-3 5/8"	23.0	13.0	37.0	0.7	0156 7804 081
	HD 83-105/16 C8	83-105	3 1/4-4 1/8"	23.0	13.0	37.0	0.7	0156 7804 094
	HD 95-118/16 C8	95-118	3 3/4-4 5/8"	23.0	13.0	37.0	0.7	0156 7804 106
	HD 108-130/16 C8	108-130	4 1/4-5 1/8"	23.0	13.0	37.0	0.7	0156 7804 119
	HD 121-143/16 C8	121-143	4 3/4-5 5/8"	23.0	13.0	37.0	0.7	0156 7804 132
	HD 133-156/16 C8	133-156	5 1/4-6 1/8"	23.0	13.0	37.0	0.7	0156 7804 144
	HD 146-168/16 C8	146-168	5 3/4-6 5/8"	23.0	13.0	37.0	0.7	0156 7804 157
	HD 159-181/16 C8	159-181	6 1/4-7 1/8"	23.0	13.0	37.0	0.7	0156 7804 170
	HD 172-194/16 C8	172-194	6 3/4-7 5/8"	23.0	13.0	37.0	0.7	0156 7804 183
	HD 184-206/16 C8	184-206	7 1/4-8 1/8"	23.0	13.0	37.0	0.7	0156 7804 195
HD 197-219/16 C8	197-219	7 3/4-8 5/8"	23.0	13.0	37.0	0.7	0156 7804 208	
HD 210-232/16 C8	210-232	8 1/4-9 1/8"	23.0	13.0	37.0	0.7	0156 7804 221	

Other sizes available on request

Refer to page 199

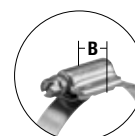

B = overall width
housing

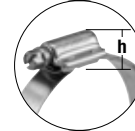

h = overall height
bolt and housing

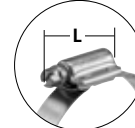

L = overall length
bolt and housing

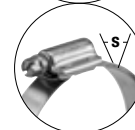

s = band thickness
clamp band

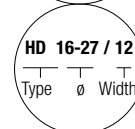

Name structure
clamp band

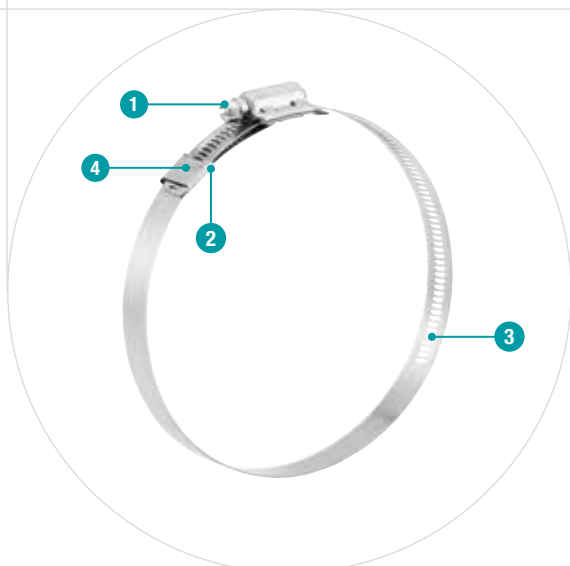

- 1 Screw housing for easy tightening
- 2 'In-line' housing, which enables every thread on the worm to engage with the band
- 3 Perforated band
- 4 Safety buckle, keeping the band aligned

Signage clamp

The NORMACLAMP® Hi-Torque Signage Clamp is produced using components entirely manufactured from stainless steel. The construction of the worm-drive housing on the band facilitates installation of a wide range of signs. Hi-Torque clamps are reusable and easy to retighten after expansion

caused by temperature fluctuations, and their construction ensures that during installation there are no sharp edges which might cause injury to the installer. The recommended tightening torque for secure and reliable installation is 16 Nm and the breaking torque is more than 20 Nm.

Advantages at a glance

- Reusable
- Secure and reliable installation
- Easy to retighten in cases of expansion (due to temperature fluctuations)
- No loss of material when installing
- Easy installation of two signs on one pole

Applications

- Traffic signs, street signs, billboards and illuminated signs installation
- Heavy duty sealing applications
- Agricultural
- Chemical Industry
- Food Processing
- Fluid Transfer
- Marine Industry
- Petrochemical Industry
- Shipyards

Materials

W1	W2	W3	W4	W5
			x	

Technical data & Ordering information

NORMACLAMP® HI-TORQUE				
Width	Designation	Clamping ranges		W4 Product No.
		in mm	in inches	
16	HI-TORQUE 32-67/16	32-67	1 1/4-2 5/8"	0560 6610 050
	HI-TORQUE 54-105/16	54-105	2 1/8-4 1/8"	0560 6610 080
	HI-TORQUE 102-156/16	102-156	4-6 1/8"	0560 6610 129
	HI-TORQUE 156-232/16	156-232	6 1/8-9 1/8"	0560 6610 194
	HI-TORQUE 229-384/16	229-384	9-15 1/8"	0560 6610 307



Refer to page 199.

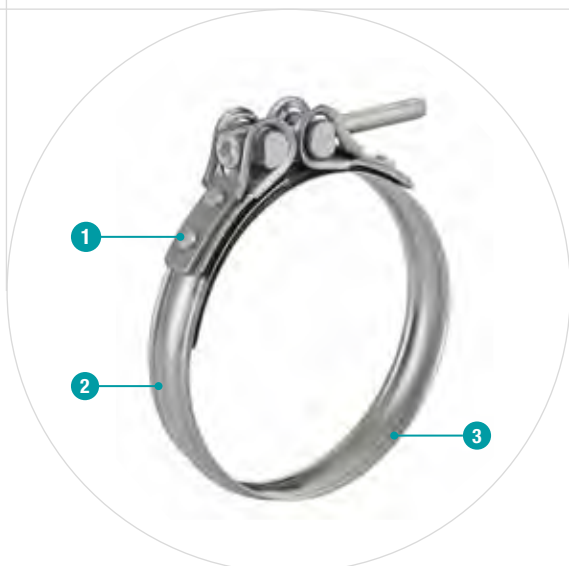

- 1 Mechanical locking with rivets
- 2 Omega-profile shaped band design
- 3 Round edges to prevent damage to the pipe



Connecting hoses for charged air application

NORMACLAMP® CC is a high performance clamp designed to connect rubber or silicon hoses in high pressure applications. It produces a constantly sealed joint between turbocharger and engine under extremely high temperature and pressure variations.

Advantages at a glance

- Uniform radial distribution of clamping forces
- No intercrystalline corrosion
- High surface pressure compared to flat band clamps
- Spring function included in omega profile band

Applications

Automotive industry - charged air for turbochargers

Materials

W1	W2	W3	W4	W5
		x		

Technical data & Ordering information

NORMACLAMP® CC			
Width	Designation	Clamping ranges	W3 Product No.
		in mm	
17	CC 70-72	70 - 72	0596 6001 072
	CC 72-74	72 - 74	0596 6001 074
	CC 74-76	74 - 76	0596 6001 076
	CC 76-78	76 - 78	0596 6001 078
	CC 78-80	78 - 80	0596 6001 080
	CC 80-82	80 - 82	0596 6001 082
	CC 82-84	82 - 84	0596 6001 084
	CC 84-86	84 - 86	0596 6001 086
	CC 86-88	86 - 88	0596 6001 088
	CC 88-90	88 - 90	0596 6001 090
	CC 90-92	90 - 92	0596 6001 092
	CC 92-94	92 - 94	0596 6001 094
	CC 94-96	94 - 96	0596 6000 096
	CC 96-98	96 - 98	0596 6000 098
	CC 98-100	98 - 100	0596 6000 100
	CC 100-102	100 - 102	0596 6000 102
	CC 102-104	102 - 104	0596 6000 104
	CC 104-106	104 - 106	0596 6000 106
	CC 106-108	106 - 108	0596 6001 108
	CC 108-110	108 - 110	0596 6001 110
	CC 110-112	110 - 112	0596 6000 112
	CC 112-114	112 - 114	0596 6000 114
	CC 114-116	114 - 116	0596 6000 116
	CC 120-122	120 - 122	0596 6000 122
CC 122-124	122 - 124	0596 6000 124	
CC 124-126	124 - 126	0596 6000 126	
CC 132-134	132 - 134	0596 6000 134	

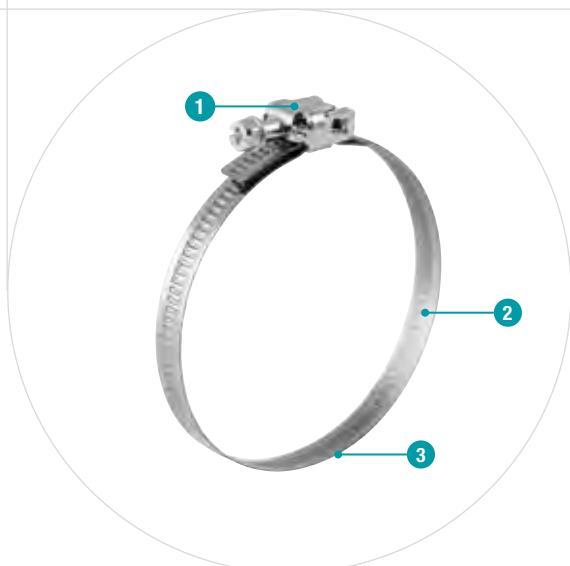

- 1 Quick Lock Housing
- 2 Smooth inner band
- 3 Smooth edges to prevent damage to the pipe

Quick locking clamp

NORMACLAMP® Quick Lock 9 mm is manufactured from a continuously threaded band with smooth edges to prevent damage to the pipe. The Quick Lock housing allows easy and quick application, as the band can

be adjusted to the right diameter of the pipe, before securing the lock with the screw. Band thickness 0.6 mm for band width 9 mm.

Advantages at a glance

- Easy and quick application
- Safe joint with the hose
- Flexibility
- Clamping range from 25-40 up to 60-1300 mm

Applications

- Water industry
- Air conditioning
- Construction
- Sanitary

Materials

W1	W2 (B) *	W3	W4	W5
	x		x	

*W2 (B): Band in stainless steel (W3)
 Screw and housing in galvanized steel (W1)
 W2 (B) is a combination of W1 and W3 materials

Torques

Band width	Tightening torque	Tightening speed
9	2.5 +0.5 Nm	Max. 50 RPM

Technical data & Ordering information

NORMACLAMP® QUICK LOCK 9 MM					
Width	Designation	Clamping ranges		W2 (B) Product No.	W4 Product No.
		in mm	in inches		
9	QUICK LOCK 25-40/9	25-40	1-1 9/16"	0815 6120 040	
	QUICK LOCK 25-45/9	25-45	1-1 3/4"	0815 6120 045	
	QUICK LOCK 32-50/9	32-50	1 1/4-2"	0815 6120 050	
	QUICK LOCK 40-60/9	40-60	1 9/16-2 3/8"	0815 6120 060	
	QUICK LOCK 50-70/9	50-70	2-2 3/4"	0815 6120 070	
	QUICK LOCK 60-80/9	60-80	2 3/8-3 1/8"	0815 6120 080	
	QUICK LOCK 60-90/9	60-90	2 3/8-3 9/16"	0815 6120 090	
	QUICK LOCK 60-100/9	60-100	2 3/8-3 15/16"	0815 6120 100	
	QUICK LOCK 60-110/9	60-110	2 3/8-4 5/16"	0815 6120 110	0815 6130 110
	QUICK LOCK 60-125/9	60-125	2 3/8-4 15/16"	0815 6120 125	
	QUICK LOCK 60-135/9	60-135	2 3/8-5 5/16"	0815 6120 135	0815 6130 135
	QUICK LOCK 60-145/9	60-145	2 3/8-5 11/16"	0815 6120 145	0815 6130 145
	QUICK LOCK 60-165/9	60-165	2 3/8-6 1/2"	0815 6120 165	
	QUICK LOCK 60-170/9	60-170	2 3/8-6 11/16"		0815 6130 170
	QUICK LOCK 60-175/9	60-175	2 3/8-6 7/8"	0815 6120 175	
	QUICK LOCK 60-215/9	60-215	2 3/8-8 7/16"	0815 6120 215	0815 6130 215
	QUICK LOCK 60-270/9	60-270	2 3/8-10 5/8"	0815 6120 270	0815 6130 270
	QUICK LOCK 60-280/9	60-280	2 3/8-11"	0815 6120 280	
	QUICK LOCK 60-290/9	60-290	2 3/8-11 7/16"	0815 6120 290	
	QUICK LOCK 60-325/9	60-325	2 3/8-12 13/16"	0815 6120 325	0815 6130 325
	QUICK LOCK 60-370/9	60-370	2 3/8-14 9/16"	0815 6120 370	
	QUICK LOCK 60-380/9	60-380	2 3/8- 14 15/16"	0815 6120 380	0815 6130 380
	QUICK LOCK 60-425/9	60-425	2 3/8-16 3/4"	0815 6120 425	0815 6130 425
	QUICK LOCK 60-525/9	60-525	2 3/8-20 11/16"	0815 6120 525	0815 6130 525
	QUICK LOCK 60-630/9	60-630	2 3/8-24 13/16"	0815 6120 630	
	QUICK LOCK 60-660/9	60-660	2 3/8-26"	0815 6120 660	0815 6130 660
QUICK LOCK 60-1050/9	60-1050	2 3/8-41 5/16"	0815 6121 050		
QUICK LOCK 60-1300/9	60-1300	2 3/8-51 3/16"	0815 6121 300		

Additional diameters available on request



Refer to page 190 and 194.

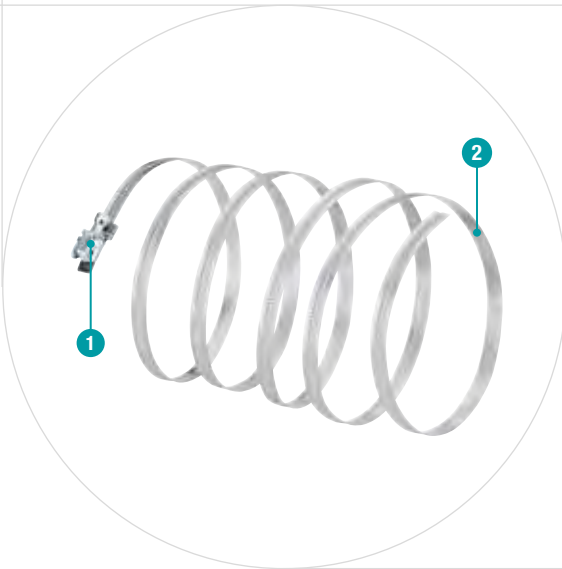

- 1 Quick Lock Housing
- 2 Perforated band to provide an ideal contact surface for the hose

The clamp for large hoses

NORMACLAMP® Quick lock 12 mm is designed for quick-lock tightening and releasing of large diameter hoses and supplied in a perforated band, to provide an ideal contact surface for the hose. This clamp is the ideal solution for larger hose diameters over 100 mm. Band thickness 0.7 mm for band width 12 mm assures a very flexible clamp.

Advantages at a glance

- The quick-lock housing eases the assembly of the clamp
- Safe joint with the hose
- Flexibility
- Wide clamping range

Applications

- Water industry
- Air conditioning
- Construction
- Sanitary

Materials

W1	W2 (B) *	W3	W4	W5
	x			

*W2 (B): Band in stainless steel (W3)
Screw and housing in galvanized steel (W1)
W2 (B) is a combination of W1 and W3 materials

Technical data & Ordering information

NORMACLAMP® QUICK LOCK 12 MM				
Width	Designation	Clamping ranges		W2 (B) Product No.
		in mm	in inches	
12	QUICK LOCK 50-110/12	50-110	2-4 5/16"	0815 6020 080
	QUICK LOCK 50-130/12	50-130	2-5 1/8"	0815 6020 090
	QUICK LOCK 50-145/12	50-145	2-5 11/16"	0815 6020 098
	QUICK LOCK 50-165/12	50-165	2-6 1/2"	0815 6020 108
	QUICK LOCK 50-175/12	50-175	2-6 7/8"	0815 6020 113
	QUICK LOCK 50-215/12	50-215	2-8 7/16"	0815 6020 133
	QUICK LOCK 50-280/12	50-280	2-11"	0815 6020 165
	QUICK LOCK 50-325/12	50-325	2-12 13/16"	0815 6020 188
	QUICK LOCK 50-370/12	50-370	2-14 9/16"	0815 6020 210
	QUICK LOCK 50-425/12	50-425	2-16 3/4"	0815 6020 238
	QUICK LOCK 60-525/12	60-525	2-20 11/16"	0815 6020 293
	QUICK LOCK 70-625/12	70-625	2-24 5/8"	0815 6020 348



Refer to page 190.



- 1 Dispenser for 9 mm band width (stamped band)
- 2 Dispenser for 12 mm band width (perforated band)

Continuous band for multiple clamp diameters

The NORMACLAMP® Strip steel is a perfect solution for creating clamps with different diameters depending on a user's needs. Strip steel is a long continuous band available in 9 or 12 mm band width. For closing the clamp use the NORMACLAMP® Quick lock housing 9 or 12 mm.

Advantages at a glance

- Variability
- Flexibility
- Storage and inventory benefit
- Allows making up to 44 clamps

Applications

- Water industry
- Air conditioning
- Construction
- Sanitary

Materials

W1	W2 (B) *	W3	W4	W5
	x		x	

*W2 (B): Band in stainless steel (W3)
Screw and housing in galvanized steel (W1)
W2 (B) is a combination of W1 and W3 materials

Technical data & Ordering information

NORMACLAMP® STRIP STEEL					
Width	Designation	Length		W2 (B) Product No.	W4 Product No.
		in m	in inch		
9	STRIP STEEL 9 25 MTS	25	98 7/16	0815 7121 005	0815 7131 005
	STRIP STEEL 9 30 MTS	30	118 1/8	0815 7121 008	0815 7131 008
12	STRIP STEEL 12 25 MTS	25	98 7/16	0815 0007 006	

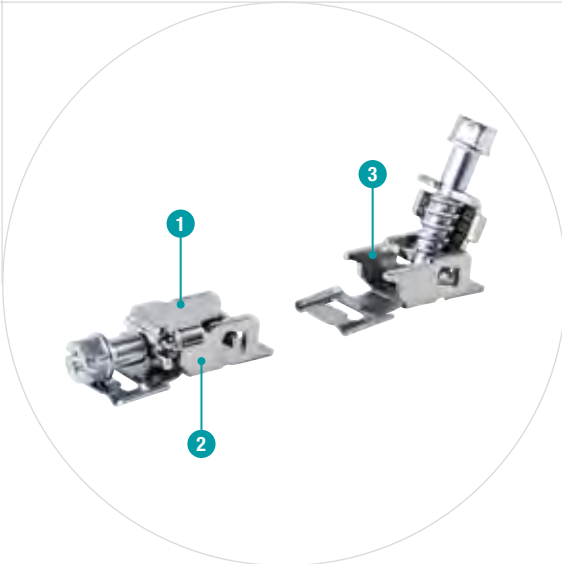

- 1 Quick-Lock housing
- 2 Closed position
- 3 Open position

Locking system for continuous band

THE NORMACLAMP® Quick lock housing 9 and 12 mm are used to close the NORMACLAMP® Strip steel.

Advantages at a glance

- Fast, simple and safe assembly
- Enables the closing of clamps of many diameters

Applications

- Water industry
- Air conditioning
- Construction
- Sanitary

Materials

W1	W2 (B) *	W3	W4	W5
	x		x	

*W2 (B): Band in stainless steel (W3)
Screw and housing in galvanized steel (W1)
W2 (B) is a combination of W1 and W3 materials

Technical data & Ordering information

NORMACLAMP® QUICK LOCK HOUSING			
Width	Designation	W2 (B) Product No.	W4 Product No.
9	QUICK LOCK HOUSING 9	0815 7121 007	0815 7131 007
12	QUICK LOCK HOUSING 12	0815 6007 008	



- 1 Bolt**
– New specially designed bolt with integrated spacer and improved performance. The W5 version has a socket head cap bolt
- 2 Reinforced band loops**
– ability to withstand much higher torques
- 3 Mechanically locked closure**
– no welding spots and no contact corrosion
- 4 Bridge**
– hose protection
- 5 Robust band with rounded edges**
– prevents injuries and damage to hoses
- 6 Hollow trunnions**
– reduces the tensile forces on the bolt and the mechanical lock

Heavy-duty clamps for multiple applications

NORMACLAMP® GBS is designed primarily for use in applications where hose clamps must meet stringent requirements. In particular if suction and pressure hoses - complete with plastic or steel inserts and high shore hardness values - are to be connected and attached. They are particularly suitable for use on commercial and special vehicles. NORMACLAMP® GBS clamps' ability to withstand exceptionally high levels of band tensile force is an outstanding feature. They are also extremely easy to install, whether you're using manual, pneumatic or electrical standard tools.

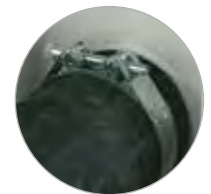

Advantages at a glance

- Failure torques improved by a factor of two
- Band tensile force levels improved by a factor of three

Applications

- Machine building
- Chemical industry
- Irrigation systems
- Ship manufacturing
- Railway industry
- Agricultural machines
- Building machines
- Engine manufacturing
- Pump and filter
- Mining Industry

Materials

W1	W2	W3	W4	W5
x	x		x	x

Material	Corrosion resistance in salt spray testing
W1	Min. 72 h
W2	Min. 72 h
W4	Min. 240 h
W5	Min. 400 h

NORMACLAMP® GBS						
Band width	Material thickness in mm					
	W1	W2	W4	W5	M	SW
18	0.8	0.6	0.6	0.6	6	8
20	1.0	0.8	0.8	0.8	7	10
25	1.0	1.0	1.0	1.0	8	13
30	1.3	1.0	1.0	1.0	10	17

Band tensile force

Numerous test results underline the technical superiority of NORMACLAMP® GBS products over their competitors':

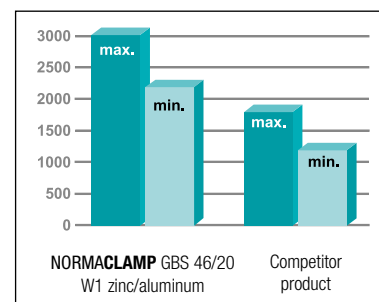

Table of torques

NORMACLAMP® GBS						NORMACLAMP® GBS RUBBER INSERT			
Band width	Failure torque (minimum) Nm				Recommended tightening torque Nm	Band width	Failure torque (minimum) Nm		Recommended tightening torque Nm
	W1	W2	W4	W5			W1	W2	
18	15	15	15	15	8	18	10	10	6
20	25	20	20	20	10	20	15	15	8
25	35	30	30	30	20	25	25	25	18
30	50	45	45	45	25	30	40	40	22

* the recommended tightening speed should not exceed 250 rpm

Technical data & Ordering information

NORMACLAMP® GBS HOLLOW TRUNNION								
Width	Designation	Clamping ranges		W1 Product No.	W2 Product No.	W4 Product No.	W5** Product No.	
		in mm	in inches					
18	GBS M17-19/18 Sk*	17-19	1 1/16-3/4"	0591 7181 018	0591 7182 018	0591 7184 018	0591 7185 018	
	GBS M19-21/18 Sk*	19-21	3/4-13/16"	0591 7181 020	0591 7182 020	0591 7184 020	0591 7185 020	
	GBS M21-23/18 Sk*	21-23	13/16-15/16"	0591 7181 022	0591 7182 022	0591 7184 022	0591 7185 022	
	GBS M23-25/18 Sk*	23-25	15/16-1"	0591 7181 024	0591 7182 024	0591 7184 024	0591 7185 024	
	GBS M25-27/18 Sk	25-27	1-1 1/16"	0591 7181 026	0591 7182 026	0591 7184 026	0591 7185 026	
	GBS M27-29/18 Sk	27-29	1 1/16-1 1/8"	0591 7181 028	0591 7182 028	0591 7184 028	0591 7185 028	
	GBS M29-31/18 Sk	29-31	1 1/8-1 1/4"	0591 7181 030	0591 7182 030	0591 7184 030	0591 7185 030	
	GBS M31-34/18 Sk	31-34	1 1/4-1 5/16"	0591 7181 033	0591 7182 033	0591 7184 033	0591 7185 033	
	GBS M34-37/18 Sk	34-37	1 5/16-1 7/16"	0591 7181 036	0591 7182 036	0591 7184 036	0591 7185 036	
	GBS M37-40/18 Sk	37-40	1 7/16-1 9/16"	0591 7181 039	0591 7182 039	0591 7184 039	0591 7185 039	
GBS M40-43/18 Sk	40-43	1 9/16-1 11/16"	0591 7181 042	0591 7182 042	0591 7184 042	0591 7185 042		
20	GBS M43-47/20 Sk	43-47	1 11/16-1 7/8"	0591 7201 045	0591 7202 045	0591 7204 045	0591 7205 045	
	GBS M47-51/20 Sk	47-51	1 7/8-2"	0591 7201 049	0591 7202 049	0591 7204 049	0591 7205 049	
	GBS M51-55/20 Sk	51-55	2-2 3/16"	0591 7201 053	0591 7202 053	0591 7204 053	0591 7205 053	
	GBS M55-59/20 Sk	55-59	2 3/16-2 5/16"	0591 7201 057	0591 7202 057	0591 7204 057	0591 7205 057	
	GBS M59-63/20 Sk	59-63	2 5/16-2 1/2"	0591 7201 061	0591 7202 061	0591 7204 061	0591 7205 061	
	GBS M63-68/20 Sk	63-68	2 1/2-2 11/16"	0591 7201 066	0591 7202 066	0591 7204 066	0591 7205 066	
	GBS M68-73/25 Sk	68-73	2 11/16-2 7/8"	0591 7251 071	0591 7252 071	0591 7254 071	0591 7255 071	
25	GBS M73-79/25 Sk	73-79	2 7/8-3 1/8"	0591 7251 076	0591 7252 076	0591 7254 076	0591 7255 076	
	GBS M79-85/25 Sk	79-85	3 1/8-3 3/8"	0591 7251 082	0591 7252 082	0591 7254 082	0591 7255 082	
	GBS M85-91/25 Sk	85-91	3 3/8-3 9/16"	0591 7251 088	0591 7252 088	0591 7254 088	0591 7255 088	
	GBS M91-97/25 Sk	91-97	3 9/16-3 13/16"	0591 7251 094	0591 7252 094	0591 7254 094	0591 7255 094	
	GBS M97-104/25 Sk	97-104	3 13/16-4 1/16"	0591 7251 101	0591 7252 101	0591 7254 101	0591 7255 101	
	GBS M104-112/25 Sk	104-112	4 1/16-4 7/16"	0591 7251 108	0591 7252 108	0591 7254 108	0591 7255 108	
	GBS M112-121/25 Sk	112-121	4 7/16-4 3/4"	0591 7251 117	0591 7252 117	0591 7254 117	0591 7255 117	
	GBS M121-130/25 Sk	121-130	4 3/4-5 1/8"	0591 7251 126	0591 7252 126	0591 7254 126	0591 7255 126	
	30	GBS M130-140/30 Sk	130-140	5 1/8-5 1/2"	0591 7301 135	0591 7302 135	0591 7304 135	0591 7305 135
		GBS M140-150/30 Sk	140-150	5 1/2-5 15/16"	0591 7301 145	0591 7302 145	0591 7304 145	0591 7305 145
GBS M150-162/30 Sk		150-162	5 15/16-6 3/8"	0591 7301 156	0591 7302 156	0591 7304 156	0591 7305 156	
GBS M162-174/30 Sk		162-174	6 3/8-6 7/8"	0591 7301 168	0591 7302 168	0591 7304 168	0591 7305 168	
GBS M174-187/30 Sk		174-187	6 7/8-7 3/8"	0591 7301 181	0591 7302 181	0591 7304 181	0591 7305 181	
GBS M187-200/30 Sk		187-200	7 3/8-7 7/8"	0591 7301 194	0591 7302 194	0591 7304 194	0591 7305 194	
GBS M200-213/30 Sk		200-213	7 7/8-8 3/8"	0591 7301 207	0591 7302 207	0591 7304 207	0591 7305 207	
GBS M213-226/30 Sk		213-226	8 3/8-8 7/8"	0591 7301 220	0591 7302 220	0591 7304 220	0591 7305 220	
GBS M226-239/30 Sk		226-239	8 7/8-9 7/16"	0591 7301 233	0591 7302 233	0591 7304 233	0591 7305 233	
GBS M239-252/30 Sk		239-252	9 7/16-9 15/16"	0591 7301 246	0591 7302 246	0591 7304 246	0591 7305 246	
GBS M252-265/30 Sk		252-265	9 15/16-10 7/16"	0591 7301 259	0591 7302 259	0591 7304 259	0591 7305 259	
GBS M265-278/30 Sk		265-278	10 7/16-10 15/16"	0591 7301 272	0591 7302 272	0591 7304 272	0591 7305 272	
GBS M279-291/30 Sk		279-291	11-11 7/16"	0591 7301 285	0591 7302 285	0591 7304 285	0591 7305 285	
GBS M292-304/30 Sk		292-304	11 1/2-12"	0591 7301 298	0591 7302 298	0591 7304 298	0591 7305 298	

* These diameters are full trunnions and do not feature a mechanically locked closure, they are spot-welded.

** ISK bolt for W5 material

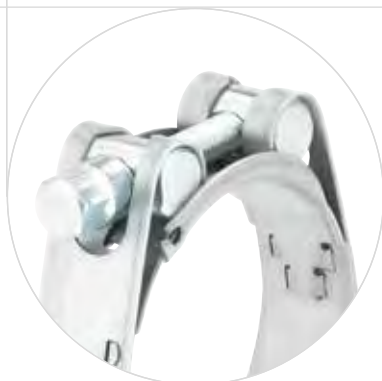

To suit the requirements of all markets, NORMACLAMP® GBS is also available with solid trunnions.

Main advantage

Strong robustness

Materials

W1, W4

NORMACLAMP® GBS STC					
Width	Description	Clamping range		W1 Product No.	W4 Product No.
		in mm	in inches		
18	GBS M17-19/18 STC	17 - 19	11/16-3/4"	0591 7001 018	0591 7009 018
	GBS M19-21/18 STC	19 - 21	3/4-13/16"	0591 7001 020	0591 7009 020
	GBS M21-23/18 STC	21 - 23	13/16-15/16"	0591 7001 022	0591 7009 022
	GBS M23-25/18 STC	23 - 25	15/16-1"	0591 7001 024	0591 7009 024
	GBS M25-27/18 STC	25 - 27	1-1 1/16"	0591 7001 026	0591 7009 026
	GBS M27-29/18 STC	27 - 29	1 1/16-1 1/8"	0591 7001 028	0591 7009 028
	GBS M29-31/18 STC	29 - 31	1 1/8-1 1/4"	0591 7001 030	0591 7009 030
	GBS M31-34/18 STC	31 - 34	1 1/4-1 5/16"	0591 7001 033	0591 7009 033
	GBS M34-37/18 STC	34 - 37	1 5/16-1 7/16"	0591 7001 036	0591 7009 036
	GBS M37-40/18 STC	37 - 40	1 7/16-1 9/16"	0591 7001 039	0591 7009 039
GBS M40-43/18 STC	40 - 43	1 9/16-1 11/16"	0591 7001 042	0591 7009 042	
20	GBS M43-47/20 STC	43 - 47	1 11/16-1 7/8"	0591 7002 045	0591 7010 045
	GBS M47-51/20 STC	47 - 51	1 7/8-2"	0591 7002 049	0591 7010 049
	GBS M51-55/20 STC	51 - 55	2-2 3/16"	0591 7002 053	0591 7010 053
	GBS M55-59/20 STC	55 - 59	2 3/16-2 5/16"	0591 7002 057	0591 7010 057
	GBS M59-63/20 STC	59 - 63	2 5/16-2 1/2"	0591 7002 061	0591 7010 061
	GBS M63-68/20 STC	63 - 68	2 1/2-2 11/16"	0591 7002 066	0591 7010 066
25	GBS M68-73/25 STC	68 - 63	2 11/16-2 7/8"	0591 7003 071	0591 7011 071
	GBS M73-79/25 STC	73 - 79	2 7/8-3 1/8"	0591 7003 076	0591 7011 076
	GBS M79-85/25 STC	79 - 85	3 1/8-3 3/8"	0591 7003 082	0591 7011 082
	GBS M85-91/25 STC	85 - 91	3 3/8-3 9/16"	0591 7003 088	0591 7011 088
	GBS M91-97/25 STC	91 - 97	3 9/16-3 13/16"	0591 7003 094	0591 7011 094
	GBS M97-104/25 STC	97 - 104	3 13/16-4 1/8"	0591 7003 101	0591 7011 101
	GBS M104-112/25 STC	104 - 112	4 1/16-4 7/16"	0591 7003 108	0591 7011 108
	GBS M112-121/25 STC	112 - 121	4 7/16-4 3/4"	0591 7003 117	0591 7011 117
GBS M121-130/25 STC	121 - 130	4 3/4-5 1/8"	0591 7003 126	0591 7011 126	
30	GBS M130-140/30 STC	130 - 140	5 1/8-5 1/2"	0591 7004 135	0591 7012 135
	GBS M140-150/30 STC	140 - 150	5 1/2-5 15/16"	0591 7004 145	0591 7012 145
	GBS M150-162/30 STC	150 - 162	5 15/16-6 3/8"	0591 7004 156	0591 7012 156
	GBS M162-174/30 STC	162 - 174	6 3/8-6 7/8"	0591 7004 168	0591 7012 168
	GBS M174-187/30 STC	174 - 187	6 7/8-7 3/8"	0591 7004 181	0591 7012 181
	GBS M187-200/30 STC	187 - 200	7 3/8-7 7/8"	0591 7004 194	0591 7012 194
	GBS M200-213/30 STC	200 - 213	7 7/8-8 3/8"	0591 7004 207	0591 7012 207
	GBS M213-226/30 STC	213 - 226	8 3/8-8 7/8"	0591 7004 220	0591 7012 220
	GBS M226-239/30 STC	226 - 239	8 7/8-9 7/16"	0591 7004 233	0591 7012 233
	GBS M239-252/30 STC	239 - 252	9 7/16-9 15/16"	0591 7004 246	0591 7012 246
	GBS M252-265/30 STC	252 - 265	9 15/16-10 7/16"	0591 7004 259	0591 7012 259
	GBS M265-278/30 STC	265 - 278	10 7/16-10 15/16"	0591 7004 272	0591 7012 272
	GBS M278-291/30 STC	278 - 291	10 15/16-11 7/16"	0591 7004 285	0591 7012 285
	GBS M291-304/30 STC	291 - 304	11 7/16-12"	0591 7004 298	0591 7012 298
	GBS M304-317/30 STC	304 - 317	12-12 1/2"	0591 7004 311	0591 7012 311
	GBS M317-330/30 STC	317 - 330	12 1/2-13"	0591 7004 324	0591 7012 324



NORMACLAMP® GBS is also available with a Quick Release Closure. The bolt on the closure is easy to release, ensuring straightforward installation and removal.

Main advantage

Easy to install

Materials

W1, W2

NORMACLAMP® GBS QRC					
Width	Description	Clamping range		W1 Product No.	W2 Product No.
		in mm	in inches		
18	GBS M17-19/18 Zy QRC*	17 - 19	11/16-3/4"	0592 7181 018	0592 7182 018
	GBS M19-21/18 Zy QRC*	19 - 21	3/4-13/16"	0592 7181 020	0592 7182 020
	GBS M21-23/18 Zy QRC*	21 - 23	13/16-15/16"	0592 7181 022	0592 7182 022
	GBS M23-25/18 Zy QRC*	23 - 25	15/16-1"	0592 7181 024	0592 7182 024
	GBS M25-27/18 Zy QRC	25 - 27	1-1 1/16"	0592 7181 026	0592 7182 026
	GBS M27-29/18 Zy QRC	27 - 29	1 1/16-1 1/8"	0592 7181 028	0592 7182 028
	GBS M29-31/18 Zy QRC	29 - 31	1 1/8-1 1/4"	0592 7181 030	0592 7182 030
	GBS M31-34/18 Zy QRC	31 - 34	1 1/4-1 5/16"	0592 7181 033	0592 7182 033
	GBS M34-37/18 Zy QRC	34 - 37	1 5/16-1 7/16"	0592 7181 036	0592 7182 036
	GBS M37-40/18 Zy QRC	37 - 40	1 7/16-1 9/16"	0592 7181 039	0592 7182 039
GBS M40-43/18 Zy QRC	40 - 43	1 9/16-1 11/16"	0592 7181 042	0592 7182 042	
20	GBS M43-47/20 Zy QRC	43 - 47	1 11/16-1 7/8"	0592 7201 045	0592 7202 045
	GBS M47-51/20 Zy QRC	47 - 51	1 7/8-2"	0592 7201 049	0592 7202 049
	GBS M51-55/20 Zy QRC	51 - 55	2-2 3/16"	0592 7201 053	0592 7202 053
	GBS M55-59/20 Zy QRC	55 - 59	2 3/16-2 5/16"	0592 7201 057	0592 7202 057
	GBS M59-63/20 Zy QRC	59 - 63	2 5/16-2 1/2"	0592 7201 061	0592 7202 061
	GBS M63-68/20 Zy QRC	63 - 68	2 1/2-2 11/16"	0592 7201 066	0592 7202 066
25	GBS M68-73/25 Zy QRC	68 - 73	2 11/16-2 7/8"	0592 7251 071	0592 7252 071
	GBS M73-79/25 Zy QRC	73 - 79	2 7/8-3 1/8"	0592 7251 076	0592 7252 076
	GBS M79-85/25 Zy QRC	79 - 85	3 1/8-3 3/8"	0592 7251 082	0592 7252 082
	GBS M85-91/25 Zy QRC	85 - 91	3 3/8-3 9/16"	0592 7251 088	0592 7252 088
	GBS M91-97/25 Zy QRC	91 - 97	3 9/16-3 13/16"	0592 7251 094	0592 7252 094
	GBS M97-104/25 Zy QRC	97 - 104	3 13/16-4 1/8"	0592 7251 101	0592 7252 101
	GBS M104-112/25 Zy QRC	104 - 112	4 1/16-4 7/16"	0592 7251 108	0592 7252 108
	GBS M112-121/25 Zy QRC	112 - 121	4 7/16-4 3/4"	0592 7251 117	0592 7252 117
GBS M121-130/25 Zy QRC	121 - 130	4 3/4-5 1/8"	0592 7251 126	0592 7252 126	
30	GBS M130-140/30 Zy QRC	130 - 140	5 1/8-5 1/2"	0592 7301 135	0592 7302 135
	GBS M140-150/30 Zy QRC	140 - 150	5 1/2-5 15/16"	0592 7301 145	0592 7302 145
	GBS M150-162/30 Zy QRC	150 - 162	5 15/16-6 3/8"	0592 7301 156	0592 7302 156
	GBS M162-174/30 Zy QRC	162 - 174	6 3/8-6 7/8"	0592 7301 168	0592 7302 168
	GBS M174-187/30 Zy QRC	174 - 187	6 7/8-7 3/8"	0592 7301 181	0592 7302 181
	GBS M187-200/30 Zy QRC	187 - 200	7 3/8-7 7/8"	0592 7301 194	0592 7302 194
	GBS M200-213/30 Zy QRC	200 - 213	7 7/8-8 3/8"	0592 7301 207	0592 7302 207
	GBS M213-226/30 Zy QRC	213 - 226	8 3/8-8 7/8"	0592 7301 220	0592 7302 220
	GBS M226-239/30 Zy QRC	226 - 239	8 7/8-9 7/16"	0592 7301 233	0592 7302 233
	GBS M239-252/30 Zy QRC	239 - 252	9 7/16-9 15/16"	0592 7301 246	0592 7302 246

These diameters do not feature a mechanically locked closure, they are spot-welded.

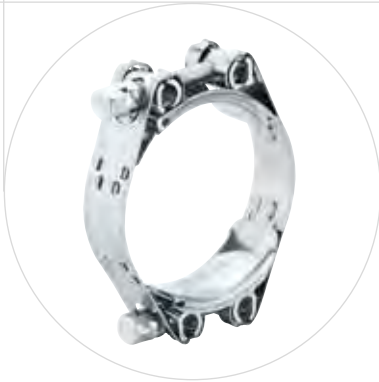

NORMACLAMP® GBS is also available in a multi-part version for bigger diameters.

Main advantage

Suitable for big diameter hoses

Materials

W1, W2, W4, W5

NORMACLAMP® GBS MULTI-PARTS							
Width	Description	Clamping range		W1 Product No.	W2 Product No.	W4 Product No.	W5 Product No.
		in mm	in inches				
18	GBS M59-67/18 SK 2T	59-67	2 5/16-2 5/8"	0591 7191 063	0591 7192 063	0591 7194 063	0591 7195 063
	GBS M67-75/18 SK 2T	67-75	2 5/8-2 15/16"	0591 7191 071	0591 7192 071	0591 7194 071	0591 7195 071
20	GBS M67-75/20 SK 2T	67-75	2 5/8-2 15/16"	0591 7221 071	0591 7222 071	0591 7224 071	0591 7225 071
	GBS M75-83/20 SK 2T	75-83	2 15/16-3 1/4"	0591 7221 079	0591 7222 079	0591 7224 079	0591 7225 079
	GBS M83-91/20 SK 2T	83-91	3 1/4-3 9/16"	0591 7221 087	0591 7222 087	0591 7224 087	0591 7225 087
25	GBS M88-100/25 SK 2T	88-100	3 9/16-4"	0591 7271 094	0591 7272 094	0591 7274 094	0591 7275 094
	GBS M100-116/25 SK 2T	100-116	3 7/16-4 9/16"	0591 7271 108	0591 7272 108	0591 7274 108	0591 7275 108
	GBS M116-136/25 SK 2T	116-136	4 9/16-5 3/8"	0591 7271 126	0591 7272 126	0591 7274 126	0591 7275 126
	GBS M136-156/25 SK 2T	136-156	5 3/8-6 1/8"	0591 7271 146	0591 7272 146	0591 7274 146	0591 7275 146
	GBS M156-176/25 SK 2T	156-176	6 1/8-6 15/16"	0591 7271 168	0591 7272 168	0591 7274 168	0591 7275 168
30	GBS M125-145/30 SK 2T	125-145	4 15/16-5 11/16"	0591 7321 135	0591 7322 135	0591 7324 135	0591 7325 135
	GBS M145-168/30 SK 2T	145-168	5 11/16-6 5/8"	0591 7321 156	0591 7322 156	0591 7324 156	0591 7325 156
	GBS M168-193/30 SK 2T	168-193	6 5/8-7 5/8"	0591 7321 181	0591 7322 181	0591 7324 181	0591 7325 181
	GBS M193-220/30 SK 2T	193-220	7 5/8-8 11/16"	0591 7321 207	0591 7322 207	0591 7324 207	0591 7325 207
	GBS M220-245/30 SK 2T	220-245	8 11/16-9 5/8"	0591 7321 233	0591 7322 233	0591 7324 233	0591 7325 233
	GBS M245-270/30 SK 2T	245-270	9 5/8-10 5/8"	0591 7321 258	0591 7322 258	0591 7324 258	0591 7325 258
	GBS M270-295/30 SK 2T	270-295	10 5/8-11 5/8"	0591 7321 283	0591 7322 283	0591 7324 283	0591 7325 283
	GBS M295-320/30 SK 2T	295-320	11 5/8-12 5/8"	0591 7321 308	0591 7322 308	0591 7324 308	0591 7325 308
	GBS M320-345/30 SK 2T	320-345	12 5/8-13 9/16"	0591 7321 333	0591 7322 333	0591 7324 333	0591 7325 333

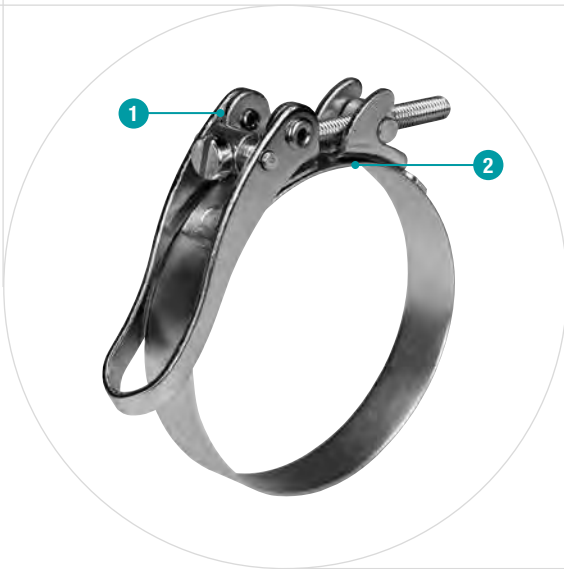

- 1 Quick close and release**
– Secure over-center lever for manual opening and closing without the need for installation tools
- 2 Bridge**
– Optimum hose protection

Quick-release clamps

NORMACLAMP® SVS and NORMACLAMP® SVS P clamps are secure, flexible joining elements designed for applications where joints need to be closed and released frequently and quickly, such as filtering and filling systems or food industry pipeline systems that are continually being cleaned.

NORMACLAMP® SVS clamps provide optimal protection for hose applications. NORMACLAMP® SVS P clamps provide optimal protection for pipe applications. NORMACLAMP® SVS PR clamps provide optimal protection for flange applications - see our Profile section on page 129.

Main advantage

Ideal for frequent handling

Applications

- Machine building
- Chemical industry
- Food and beverage industry
- Railway industry
- Building machines
- Pump and filter

Materials

W1	W2	W3	W4	W5
			x	

Material	Corrosion resistance in salt spray testing
W4	Min. 240 h

Technical data

Quick-release hose clamps (SVS)							
Band width	Minimum \emptyset	Maximum \emptyset	Material	Bolts			Closing force N
				W4	(0e)	Zy	
15	80	500	0.6	(•)	•	6	80
20	80	500	0.8	(•)	•	6	80
25	80	500	1.0	(•)	•	6	80

Technical data & Ordering information

NORMACLAMP® SVS			
Diameter in mm	Material W4 Product No.		
	Band width		
	15 mm	20 mm	25 mm
80 - 90	0565 0154 ...	0565 0204 ...	0565 0254 ...
up to 100	0565 0154 ...	0565 0204 ...	0565 0254 ...
up to 110	0565 0154 ...	0565 0204 ...	0565 0254 ...
up to 120	0565 0154 ...	0565 0204 ...	0565 0254 ...
up to 130	0565 0154 ...	0565 0204 ...	0565 0254 ...
up to 140	0565 0154 ...	0565 0204 ...	0565 0254 ...
up to 150	0565 0154 ...	0565 0204 ...	0565 0254 ...
up to 160	0565 0154 ...	0565 0204 ...	0565 0254 ...
up to 170	0565 0154 ...	0565 0204 ...	0565 0254 ...
up to 180	0565 0154 ...	0565 0204 ...	0565 0254 ...
up to 190	0565 0154 ...	0565 0204 ...	0565 0254 ...
up to 200	0565 0154 ...	0565 0204 ...	0565 0254 ...
up to 210	0565 0154 ...	0565 0204 ...	0565 0254 ...
up to 220	0565 0154 ...	0565 0204 ...	0565 0254 ...
up to 230	0565 0154 ...	0565 0204 ...	0565 0254 ...
up to 240	0565 0154 ...	0565 0204 ...	0565 0254 ...
up to 250	0565 0154 ...	0565 0204 ...	0565 0254 ...
up to 260	0565 0154 ...	0565 0204 ...	0565 0254 ...
up to 270	0565 0154 ...	0565 0204 ...	0565 0254 ...
up to 280	0565 0154 ...	0565 0204 ...	0565 0254 ...
up to 290	0565 0154 ...	0565 0204 ...	0565 0254 ...
up to 300	0565 0154 ...	0565 0204 ...	0565 0254 ...
up to 310	0565 0154 ...	0565 0204 ...	0565 0254 ...
up to 320	0565 0154 ...	0565 0204 ...	0565 0254 ...
up to 330	0565 0154 ...	0565 0204 ...	0565 0254 ...
up to 340	0565 0154 ...	0565 0204 ...	0565 0254 ...
up to 350	0565 0154 ...	0565 0204 ...	0565 0254 ...
up to 360	0565 0154 ...	0565 0204 ...	0565 0254 ...
up to 370	0565 0154 ...	0565 0204 ...	0565 0254 ...
up to 380	0565 0154 ...	0565 0204 ...	0565 0254 ...
up to 390	0565 0154 ...	0565 0204 ...	0565 0254 ...
up to 400	0565 0154 ...	0565 0204 ...	0565 0254 ...
up to 410	0565 0154 ...	0565 0204 ...	0565 0254 ...
up to 420	0565 0154 ...	0565 0204 ...	0565 0254 ...
up to 430	0565 0154 ...	0565 0204 ...	0565 0254 ...
up to 440	0565 0154 ...	0565 0204 ...	0565 0254 ...
up to 450	0565 0154 ...	0565 0204 ...	0565 0254 ...
up to 460	0565 0154 ...	0565 0204 ...	0565 0254 ...
up to 470	0565 0154 ...	0565 0204 ...	0565 0254 ...
up to 480	0565 0154 ...	0565 0204 ...	0565 0254 ...
up to 490	0565 0154 ...	0565 0204 ...	0565 0254 ...
up to 500	0565 0154 ...	0565 0204 ...	0565 0254 ...

... = Ø without decimals in mm

SVS P

NORMACLAMP® SVS P clamps provide optimal protection for pipe applications. Available in band widths of 15, 20 and 25 mm on request.

Advantages at a glance

- Closure can be opened and closed easily by hand
- No installation tools required
- Ideal for frequent handling

Material

W4

Eyelet bolt

As an alternative, the **NORMACLAMP®** SVS clamp closure can be fitted with an eyelet bolt. This can be particularly useful if gloves are worn during installation. Available in band widths of 15, 20 and 25 mm on request.

Advantages at a glance

- Eyelet bolt suitable for light duty series
- Easy to install even if wearing gloves

Material

W4

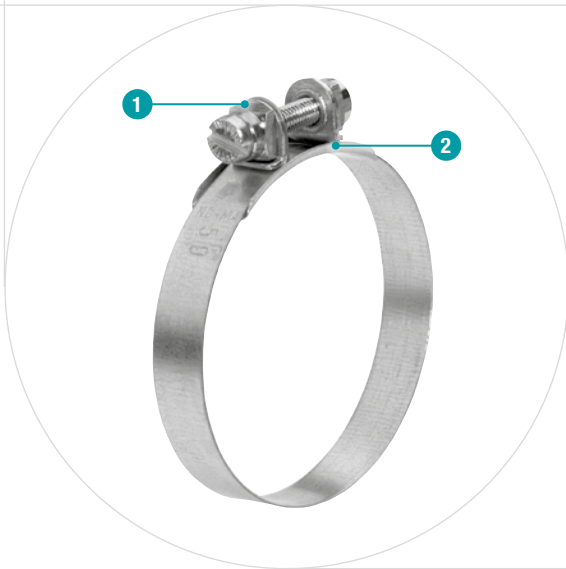

1 Powerful clamping brackets structure

Bridge

2

DIN 3016, DIN 3017

Thanks to their robust clamping brackets structure featuring metric bolts, NORMACLAMP® S/SP clamps provide a high level of clamping force. The two-part version is recommended for exceptionally high pressure and tensile loads.



Advantages at a glance

- High level of clamping force
- Even contact pressure
- Elbow fittings, brackets or lugs can be attached
- Clamps can be fitted with a rubber profile to absorb vibrations and protect against the ingress of creeping water

Applications

- Machine building
- Chemical industry
- Irrigation systems
- Ship manufacturing
- Railway industry
- Agricultural machines
- Building machines
- Engine manufacturing
- Pump and filter

Materials

W1	W2	W3	W4	W5
x			x*	x

*Only for the 30 mm band width

Material	Corrosion resistance in salt spray testing
W1	Min. 72 h
W5	Min. 400 h

NORMACLAMP® S/SP					
Band width b ₁	Minimum Ø in mm	Material thickness in mm			
		S		SP	
		W1	W5	W1	W5
5	5	0.2	–	0.2	–
7	6	0.3/0.4	0.4	0.4	0.4
9	9	0.4	0.4	0.6	0.4
12	12	0.5	0.5	0.7	0.5
15	20	0.6	0.6	0.8	0.6
20	25	1.0	0.8	(up to ø 47) 1.0 (from ø 48) 1.25	0.8
25	50	1.25	1.0	1.25/1.5	1

Bolts

NORMACLAMP® S/SP			
Band width mm	Zy	Sz	Sk
5	M 2x12		
7	M 3x16		
9	M 4x22	M 4 x 20	
12		M 5x25	
15		M 6x30	
20		M 8x40	
25			M 10x45

Static torques

NORMACLAMP® S/SP		
Band width b ₁ mm	Static tightening torque Nm	Static test torque Nm
	max.	
7	0.5	0.6
9	1.2	1.5
12	1.5	1.8
15	4	4.8
20	12	14.5
25	30	36

Static torques according to DIN 3017-2

Technical data & Ordering information

NORMACLAMP® S															
Clamping diameter, mm	W1 Product No.								W4 Product No.	W5 Product No.					
	Band width								Band width	Band width					
	5 mm Zy	7 mm Zy	9 mm Zy	12 mm Sz	15 mm Sz	20 mm Sz	25 mm Sz	30 mm Sz	30 mm Sz	7 mm Zy	9 mm Zy	12 mm Sz	15 mm Sz	20 mm Sz	25 mm Sz
up to 9	0100 8980 ...														
up to 10		0110 8980 ...	0120 8980 ...							0110 0700 ...	0120 0700 ...				
from 15			0120 8980 ...	0130 0005 ...	0140 0000 ...						0120 0700 ...	0130 0705 ...	0140 0700 ...		
up to 20			0120 8980 ...	0130 0005 ...	0140 0000 ...						0120 0700 ...	0130 0705 ...	0140 0700 ...		
up to 28			0120 8980 ...	0130 0005 ...	0140 0000 ...						0120 0700 ...	0130 0705 ...	0140 0700 ...		
up to 30			0120 8980 ...		0140 0000 ...						0120 0700 ...		0140 0700 ...		
from 36			0120 8980 ...		0140 0000 ...	0150 0000 ...					0120 0700 ...		0140 0700 ...	0150 0700 ...	
up to 40			0120 8980 ...		0140 0000 ...	0150 0000 ...					0120 0700 ...		0140 0700 ...	0150 0700 ...	
up to 50			0120 8980 ...		0140 0000 ...	0150 0000 ...	0160 0000 ...				0120 0700 ...		0140 0700 ...	0150 0700 ...	0160 0700 ...
up to 60			0120 8980 ...		0140 0000 ...	0150 0000 ...	0160 0000 ...				0120 0700 ...		0140 0700 ...	0150 0700 ...	0160 0700 ...
up to 70			0120 8980 ...		0140 0000 ...	0150 0000 ...	0160 0000 ...				0120 0700 ...		0140 0700 ...	0150 0700 ...	0160 0700 ...
up to 75			0120 8980 ...		0140 0000 ...	0150 0000 ...	0160 0000 ...	0180 0000 ...	0180 0700 ...		0120 0700 ...		0140 0700 ...	0150 0700 ...	0160 0700 ...
up to 80					0140 0000 ...	0150 0000 ...	0160 0000 ...	0180 0000 ...	0180 0700 ...				0140 0700 ...	0150 0700 ...	0160 0700 ...
up to 90					0140 0000 ...	0150 0000 ...	0160 0000 ...	0180 0000 ...	0180 0700 ...				0140 0700 ...	0150 0700 ...	0160 0700 ...
up to 100					0140 0000 ...	0150 0000 ...	0160 0000 ...	0180 0000 ...	0180 0700 ...				0140 0700 ...	0150 0700 ...	0160 0700 ...
up to 110						0150 0000 ...	0160 0000 ...	0180 0000 ...	0180 0700 ...					0150 0700 ...	0160 0700 ...
up to 120						0150 0000 ...	0160 0000 ...	0180 0000 ...	0180 0700 ...					0150 0700 ...	0160 0700 ...
up to 130						0150 0000 ...		0180 0000 ...	0180 0700 ...					0150 0700 ...	
up to 140						0150 0000 ...		0180 0000 ...	0180 0700 ...					0150 0700 ...	
up to 150						0150 0000 ...		0180 0000 ...	0180 0700 ...					0150 0700 ...	
up to 160						0150 0000 ...		0180 0000 ...	0180 0700 ...					0150 0700 ...	
up to 170						0150 0000 ...		0180 0000 ...	0180 0700 ...					0150 0700 ...	
up to 180						0150 0000 ...		0180 0000 ...	0180 0700 ...					0150 0700 ...	
up to 190						0150 0000 ...		0180 0000 ...	0180 0700 ...					0150 0700 ...	
up to 200						0150 0000 ...		0180 0000 ...	0180 0700 ...					0150 0700 ...	

... = Ø without decimals in mm
Additional diameters available on request

SP Simple

NORMACLAMP® SP Simple is suitable for attaching rubber and plastic hoses as well as rubber sleeves to pipe ends or hose spigots. This clamp can be used for clamping containers, pipes and cables.

Materials

W1, W5 on request

SP Double

NORMACLAMP® SP Double enables larger diameters to be clamped easily thanks to its multi-part design.

Materials

W1, W5 on request

SPGU

NORMACLAMP® SPGU has a rubber profile that protects against vibration and creeping water. It is also sound-absorbent and protects against contact corrosion.

Materials

W1, W5 on request





- 1 Powerful clamping brackets structure**
– secure grip
- 2 Robust band with rounded edges**
– prevents injuries and damage to hoses
- 3 Sturdy bracket**
– secure retention

Retaining clamps with brackets

NORMAFIX® HMK retaining clamps with brackets are used when high mechanical force is needed for retaining containers or pipes on ceilings and walls as well as in machine building and plant construction applications.

Standard design

This version features an “open” bracket, making it suitable for all applications in which relatively light structures are being retained and

which are subject to low mechanical loads. The standard version of the retaining clamps is available in one or two parts, and with band widths of 15, 20 and 25 mm.

These clamps can be fitted with a rubber profile for shock absorption purposes. The rubber profile simultaneously protects against the ingress of creeping water.

Advantages at a glance

- For high mechanical force
- Stable construction
- Chrome 6 free surface

Applications

- Machine building
- Chemical industry
- Irrigation systems
- Ship manufacturing
- Food and beverage industry
- Railway industry
- Agricultural machines
- Building machines
- Engine manufacturing
- Pump and filter
- Mining industry

Materials

W1	W2	W3	W4	W5
x			x	x

Rubber profiles

The rubber profiles are available in EPDM (type a) and silicone (type b) material versions.

B = band width of clamp in mm

b₁ = width in mm

s₂ = material thickness in mm

All clamps with rubber profiles are pre-assembled. The complete clamps are supplied ready for use.

When submitting requests/orders for NORMAFIX® HMK retaining clamps with brackets, please specify which rubber profile you require.

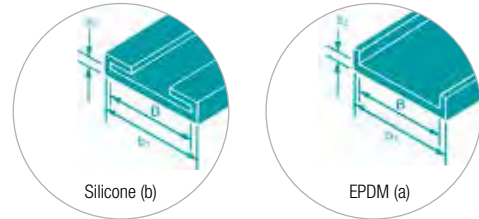

B	b ₁ ≈	s ₂
15	18.5	1.5
20	25	2.0
25	31	3.0
30	36	3.0

Technical data & Ordering information



NORMAFIX® HMK (standard design)

Band width in mm	Designation	Min. ø in mm	Min. ø in in.	Bolts			d in mm	Rubber profile		s in mm		Part Group
				Sz	Sk	Dimensions		Silicone	EPDM	W1	W5	
15	HMK STANDARD 25/15	25	1	X		M6 x 30	6.5	X	X	0.8	0.6	1416
20	HMK STANDARD 30/20	30	1 3/16	X		M8 x 40	8.5	X	X	1.0-1.5	0.8	1516
25	HMK STANDARD 50/25	50	2		X	M10 x 45	11	X	X	1.5	1.0	1616

Ordering information

When submitting requests and orders, please specify the data in the following manner:

	1. Type	2. Parts	3. Diameter	4. Band width	5. Bolt	6. Material
Example	HMK STANDARD	1616	80	25	SK	W1

Single-part heavy duty



The NORMACLAMP® HMK single-part heavy duty is suitable for applications with high mechanical loads and for retaining extremely heavy pipes and connectors.

Advantages at a glance

- Stable construction
- Chrome 6 free surface
- EPDM Rubber profile

Materials

W1, W4

Two-parts heavy duty



In the NORMACLAMP® HMK two-parts heavy duty version, the ends of the brackets are folded back and spot-welded onto the band.

Advantages at a glance

- Stable construction
- Chrome 6 free surface
- EPDM Rubber profile
- Two-parts clamp for bigger clamping range
- Suitable for larger hoses

Materials

W1, W4

K1



The NORMACLAMP® HMK K1 are prefabricated brackets which you can use to transform NORMACLAMP® standard clamps (types GBS, HD, SP and TORRO) into retaining clamps with brackets in no time at all. Just open the standard clamp, guide the band through the bracket slot, and that's all there is to it.

Advantages at a glance

- Suitable for many clamp versions
- Easy to use

Material

W1



- 1 Self-adjusting diameter**
– compensation for tolerances at the outer diameter of the hose
- 2 Color coding**
– a rapid way of visually distinguishing between nominal diameters
- 3 Protruding tool gripping points**
– easy and safe installation
- 4 Date of manufacture and machine number indicated**
- 5 Single lock-in point**
– installation indicator for easy visual checking
- 6 Band material with rounded outer edges**
– hose protection

One-piece hose clips

NORMACLAMP® COBRA products are bolt-free, one-piece hose clips. Their low overall height enables precise installation in even the tightest of spaces. NORMACLAMP® COBRA clamps are quick and easy to install.



Advantages at a glance

- Bolt-free hose clip in one piece
- Quick, easy and safe installation
- Maintenance-free fit

Applications

- Machine building
- White goods
- Chemical industry
- Irrigation systems
- Food and beverage industry
- Agricultural machines
- Engine manufacturing
- Pump and filter
- Suction lines
- Ventilation lines
- Washing machine hoses
- Pneumatic lines

Materials

W1	W2	W3	W4	W5
			x	

Material	Corrosion resistance in salt spray testing
W4	Min. 240 h

Selecting the right nominal diameter

- Push the hose onto the spigot and measure the outer diameter D_a .
- The applicable nominal diameter d_1 is then matched to this outer diameter D_a .

If required, we can send you an appropriate sample before you place your order.

If you have any additional, application-specific questions, we will be happy to advise you in more detail.

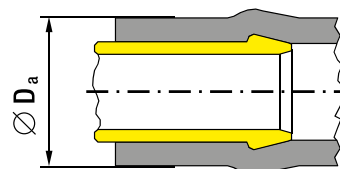

Technical data & Ordering information

NORMACLAMP® COBRA						
Width	Designation	Clamping ranges		Nominal diameter	W4 Product No.	Color
		in mm	in inches			
7	COBRA 7.5/7	8-9	5/16-3/8"	7.5	0107 7000 075	White
	COBRA 8.0/7	8.5-9.5	5/16-3/8"	8.0	0107 7000 008	Yellow
	COBRA 8.5/7	9-10	3/8-3/8"	8.5	0107 7000 085	Green
	COBRA 9.0/7	9.5-10.5	3/8-3/8"	9.0	0107 7000 009	Purple
	COBRA 9.5/7	10-11	3/8-7/16"	9.5	0107 7000 095	Black
	COBRA 10.0/7	10.5-11.5	3/8-7/16"	10	0107 7000 010	White
	COBRA 10.5/7	11-12	7/16-1/2"	10.5	0107 7000 105	Yellow
	COBRA 11.0/7	11.5-12.5	7/16-1/2"	11	0107 7000 011	Green
	COBRA 11.5/7	12-13	1/2-1/2"	11.5	0107 7000 115	Purple
8	COBRA 12/8	12.5-14	1/2-9/16"	12	0108 7006 012	Black
	COBRA 13/8	13.5-15	1/2-5/8"	13	0108 7006 013	Yellow
	COBRA 14/8	14.5-16	9/16-5/8"	14	0108 7006 014	Purple
	COBRA 15/8	15.5-17	5/8-11/16"	15	0108 7006 015	White
	COBRA 16/8	16.5-18	5/8-3/4"	16	0108 7006 016	Green
	COBRA 17/8	17.5-19	11/16-3/4"	17	0108 7006 017	Black
	COBRA 18/8	18.5-20	3/4-13/16"	18	0108 7006 018	Yellow
	COBRA 19/8	19.5-21	3/4-13/16"	19	0108 7006 019	Purple
	COBRA 20/8	20.5-22	13/16-7/8"	20	0108 7006 020	White
	COBRA 21/8	21.5-23	13/16-7/8"	21	0108 7006 021	Green
	COBRA 22/8	22.5-24	7/8-15/16"	22	0108 7006 022	Black
	COBRA 23/8	23.5-25	7/8-1"	23	0108 7006 023	Yellow
	COBRA 24/8	24.5-26	15/16-1 1/16"	24	0108 7006 024	Purple
	COBRA 25/8	25.5-27	1-1 1/16"	25	0108 7006 025	White
	COBRA 26/8	26.5-28	1 1/16-1 1/8"	26	0108 7006 026	Green
	COBRA 27/8	27.5-29	1 1/16-1 1/8"	27	0108 7006 027	Black
	COBRA 28/8	28.5-30	1 1/8-1 3/16"	28	0108 7006 028	Yellow
	COBRA 29/8	29.5-31	1 1/8-1 1/4"	29	0108 7006 029	Purple
	COBRA 30/8	30.5-32	1 3/16-1 1/4"	30	0108 7006 030	White



Refer to pages 191, 195 and 197.

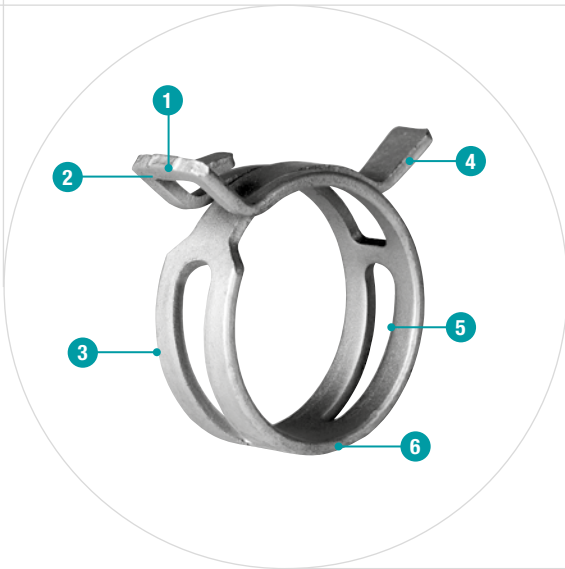

- 1 Lot number stamped on**
– reliable traceability
- 2 NORMA® logo**
– a visible sign of quality
- 3 Base and Topcoat Coating System**
– Double layered chromium VI-free coating
– provides optimum corrosion and chemical protection
- 4 Nominal diameter stamped on**
– prevents mistakes
- 5 Special design**
– even distribution of clamping force and excellent roundness
- 6 Rounded band edges**
– optimum hose protection

Springband hose clamps in acc. with DIN 3021

NORMACLAMP® FBS springband hose clamps are the perfect choice for hose spigot systems that are exposed to significant temperature fluctuations.

Once installed, their dynamic spring properties ensure an automatic re-tensioning effect over long periods of time. Even at low temperatures,

this mechanism still enables sufficiently high levels of radial clamping force to be achieved, which in turn ensures excellent sealing reliability.

With NORMACLAMP® FBS clamps even hoses that have a tendency to “creep” can be joined securely. Manual or pneumatic tools are used for professional installation.

Advantages at a glance

- One-piece, bolt-free hose clamp
- Even distribution of clamping force
- Optimum roundness
- Temperature resistance from –40 °C to 200 °C
- Automatically re-tensions to accommodate temperature fluctuations
- Clear traceability due to batch numbering

Applications

- Machine building
- White goods
- Agricultural machines
- Engine manufacturing
- Cooling and heating water circuits
- Fuel vent system
- Air ducts
- Water and brine outlet lines

Materials

Material	Zinc/aluminum coating	Organic coating	Corrosion resistance in salt spray testing
C 75 S	Base coat	Topcoat	Up to 720 h according to DIN EN ISO 9227

Short description

- Dynamic clamp
- Band material C 75 S
- Coating containing zinc; no chromium(VI)
- Nominal diameter of 13 mm to 70 mm in various graduations



At high temperatures

- Hose diameter increases
- FBS adapts to internal pressure

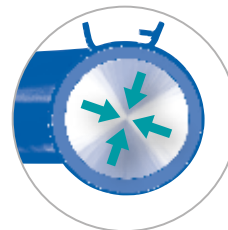

At low temperatures

- Hose diameter decreases
- FBS re-tensions
- Clamping force is retained and clamp provides perfect seal

Determine clamp size

To determine which clamp is right for you, follow these steps:

1. Push the hose onto the spigot and measure $D_{min.}$ and $D_{max.}$
2. Based on the $D_{min.}$ value, determine the nominal diameter (D_n) of the clamp in question. $D_n = D_{min.}$
3. Compare the $D_{max.}$ value with the minimum diameter ($D_{0 min.}$) specified for the open clamp and select the clamp that is appropriate.
 $D_{0 min.} \geq D_{max.}$

If required, we can send you an appropriate sample before you place your order. If you have any additional, application-specific questions, we will be happy to advise you in more detail.

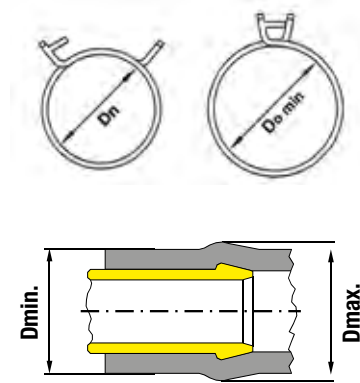

Technical data & Ordering information

NORMACLAMP® FBS STANDARD							
Width	Designation	D _n mm	D _n in inches	D _{0 m} in mm	D _{0 min} in inches	Material C 75 S Product No.	
						Black	Silver
12	FBS 13/12	13	1/2"	14.5	9/16"	0112 8024 013	0112 8074 013
	FBS 14/12	14	9/16"	15.8	5/8"	0112 8024 014	0112 8074 014
	FBS 15/12	15	9/16"	16.8	11/16"	0112 8024 015	0112 8074 015
	FBS 16/12	16	5/8"	17.5	11/16"	0112 8024 016	0112 8074 016
	FBS 17/12	17	11/16"	18.5	3/4"	0112 8024 017	0112 8074 017
	FBS 18/12	18	11/16"	19	3/4"	0112 8024 018	0112 8074 018
	FBS 19/12	19	3/4"	21	13/16"	0112 8024 019	0112 8074 019
	FBS 20/12	20	13/16"	21.6	7/8"	0112 8024 020	0112 8074 020
	FBS 21/12	21	13/16"	22.5	7/8"	0112 8024 021	0112 8074 021
	FBS 22/12	22	7/8"	24.5	15/16"	0112 8024 022	0112 8074 022
	FBS 23/12	23	15/16"	24.7	1"	0112 8024 023	0112 8074 023
	FBS 24/12	24	15/16"	26	1"	0112 8024 024	0112 8074 024
	FBS 25/12	25	1"	27	1 1/16"	0112 8024 025	0112 8074 025
	FBS 26/12	26	1"	28	1 1/8"	0112 8024 026	0112 8074 026
	FBS 27/12	27	1 1/16"	29	1 1/8"	0112 8024 027	0112 8074 027
	FBS 28/12	28	1 1/8"	30.5	1 3/16"	0112 8024 028	0112 8074 028
	FBS 29/12	29	1 1/8"	31.5	1 1/4"	0112 8024 029	0112 8074 029
	FBS 30/12	30	1 3/16"	32.5	1 1/4"	0112 8024 030	0112 8074 030
	FBS 32/12	32	1 1/4"	34.5	1 3/8"	0112 8024 032	0112 8074 032
	FBS 35/12	35	1 3/8"	38	1 1/2"	0112 8024 035	0112 8074 035
	FBS 36/12	36	1 7/16"	39	1 9/16"	0112 8024 036	0112 8074 036
	FBS 38/12	38	1 1/2"	41.5	1 5/8"	0112 8024 038	0112 8074 038
	FBS 40/12	40	1 9/16"	42.5	1 11/16"	0112 8024 040	0112 8074 040
	FBS 42/12	42	1 5/8"	44.5	1 3/4"	0112 8024 042	0112 8074 042
	FBS 44/12	44	1 3/4"	46.5	1 13/16"	0112 8024 044	0112 8074 044
	FBS 46/12	46	1 13/16"	49	1 15/16"	0112 8024 046	0112 8074 046
	FBS 47/12	47	1 7/8"	50	2"	0112 8024 047	0112 8074 047
	FBS 50/12	50	2"	53	2 1/16"	0112 8024 050	0112 8074 050
	FBS 55/12	55	2 3/16"	58	2 1/4"	0112 8024 055	0112 8074 055
	FBS 60/12	60	2 3/8"	63	2 1/2"	0112 8024 060	0112 8074 060

Special diameters available on request



Refer to pages 195 and 198.

FBS R



The **NORMACLAMP®** FBS R was designed with the aim of achieving the smallest overall height that was technically possible so that it could be used in difficult installation conditions.

Main advantage
Space-saving clamp

Material
C75S



Refer to pages 195 and 198.

FBS C



A pre-opened clamp that must be glued into place on the hose. Ask your sales representative for the gluing instructions. The retaining mechanism for this version is part of the band and is integrated into the clamp.

Advantages at a glance

- Pre-assembled clamp
- Ready to use

Material
C75S



Refer to page 195.

FBS HC



A pre-opened version that is secured by a plastic clip and can also be glued into place on the hose. Ask your Sales Representative for gluing instructions. Once the clamp has been pushed onto the hose, this clip can be released easily by hand.

Main advantage
Easy to assemble

Material
C75S

FBS MC



A pre-opened version that is secured by a metal clip and can also be glued into place on the hose. Ask your Sales Representative for gluing instructions. The retaining clip for this version is removed by using pliers.

Main advantage
Secured clamp

Material
C75S



- 1 **Ear**
– one tightening side
- 2 **Smooth inner band**
- 3 **Round edges to prevent damage**

One part clamp for low and medium pressure.

The NORMACLAMP® Earclip single has no screw. The assembly is fast, simple and safe thanks to the pinching of the ear.

Advantages at a glance

- Cost effective, and simple alternative to worm drive hose clips
- Fast and easy to install
- Ideal in narrow spaces
- Suitable for definitive fixation of connecting pipes
- To be assembled with simple ear clip pliers

Applications

- For hoses that convey compressed air or fluid
- Original equipment manufacturing
- Maintenance repair and overhaul

Materials

W1	W2	W3	W4	W5
x			x	

Technical data & Ordering information

NORMACLAMP® EARCLIP SINGLE					
Width	Description	Clamping ranges		W1 Product No.	W4 Product No.
		in mm	in inches		
6	EARCLIP SINGLE 8 - 10/6	8 - 10	5/16-3/8"	0110 7010 010	0110 7011 010
6.5	EARCLIP SINGLE 9 - 11/6.5	9 - 11	3/8-7/16"	0110 7010 011	0110 7011 011
	EARCLIP SINGLE 10 - 12/6.5	10 - 12	3/8-1/2"	0110 7010 012	0110 7011 012
	EARCLIP SINGLE 11 - 13/6.5	11 - 13	7/16-1/2"	0110 7010 013	0110 7011 013
7	EARCLIP SINGLE 12 - 14/7	12 - 14	1/2-9/16"	0110 7010 014	0110 7011 014
	EARCLIP SINGLE 13 - 15/7	13 - 15	1/2-9/16"		0110 7011 015
	EARCLIP SINGLE 14 - 16/7	14 - 16	9/16-5/8"	0110 7010 016	0110 7011 016
	EARCLIP SINGLE 16 - 18/7	16 - 18	5/8-11/16"	0110 7010 018	0110 7011 018



Refer to page 197.



- 1 Ear**
– one tightening side
- 2 Smooth inner band, and inner liner for security and roundness**
- 3 Round edges to prevent damage**
- 4 Inner liner**
– effective and powerful all-round seal

One part clamp for low and medium pressure.

The NORMACLAMP® Earclip safe has no screw. The assembly is fast, simple and safe thanks to the pinching of the ear. The inner insert allows a better distribution of the clamping force.

Advantages at a glance

- Cost effective, and simple alternative to worm drive hose clips
- Fast and easy to install
- Ideal in narrow spaces
- Suitable for definitive fixation of connecting pipes
- To be assembled with simple ear clip pliers
- Inner liner for security and better distribution of the clamping force

Applications

- For hoses that convey compressed air or fluid
- Original equipment manufacturing
- Maintenance repair and overhaul

Materials

W1	W2	W3	W4	W5
x			x	

Technical data & Ordering information

NORMACLAMP® EARCLIP SAFE					
Width	Description	Clamping ranges		W1 Product No.	W4 Product No.
		in mm	in inches		
6	EARCLIP SAFE 7.5-8.5/6	7.5-8.5	5/16-5/16"	0110 7014 008	0110 7015 008
	EARCLIP SAFE 8-9.5/6	8-9.5	5/16-3/8"	0110 7014 009	0110 7015 009
6.5	EARCLIP SAFE 9-10.5/6.5	9-10.5	3/8-7/16"	0110 7014 010	0110 7015 010
	EARCLIP SAFE 10-11.5/6.5	10-11.5	3/8-7/16"	0110 7014 011	0110 7015 011
	EARCLIP SAFE 10.5-12.5/6.5	10.5-12.5	7/16-1/2"	0110 7014 012	0110 7015 012
7	EARCLIP SAFE 11.5-13.3/7	11.5-13.3	7/16-1/2"	0110 7014 013	0110 7015 013
	EARCLIP SAFE 12.5-14.5/7	12.5-14.5	1/2-9/16"		0110 7015 014
	EARCLIP SAFE 13-15.3/7	13-15.3	1/2-5/8"	0110 7014 015	0110 7015 015
	EARCLIP SAFE 14-16/7	14-16	9/16-1/4"		0110 7015 016
	EARCLIP SAFE 15-17.3/7	15-17.3	9/16-11/16"	0110 7014 017	0110 7015 017
7.5	EARCLIP SAFE 16-18.3/7.5	16-18.3	1/4-3/4"		0110 7015 018
	EARCLIP SAFE 17-19.3/7.5	17-19.3	11-16-3/4"		0110 7015 019



Refer to page 197.



- 1 Ear – one tightening side
- 2 Round edges to prevent damage to hose



Flexible clamp to mount different sizes of rubber boots

The NORMACLAMP® CV BOOT CLAMP has no screws. The assembly is fast and reliable, thanks to pinching of the ear.

Advantages at a glance

- Clamps can be adjusted to several diameters
- Fast and easy installation
- Robust clamping due to 3 locking teeth

Applications

Automotive application - to clamp rubber boots onto drive shafts

Materials

W1	W2	W3	W4	W5
			x	

Technical data & Ordering information

NORMACLAMP® CV BOOT CLAMP			
Width	Description	Clamping ranges	
		in mm	W4 Product No.
7 mm	CV BOOT CLAMP 25 -50	25 - 50	0110 7016 050
	CV BOOT CLAMP 40 -120	40 - 120	0110 7016 120



Refer to page 197.



- 1 Ear**
– two ears for higher clamping range
- 2 Smooth inner band**
- 3 Round edges to prevent damage**

One part clamp for low and medium pressure.

The NORMACLAMP® Earclip double has no screw. The assembly is fast, simple and safe thanks to the pinching of the ears. The two ears enable a better and more constant sealing force. The tightening force is improved.

Advantages at a glance

- Cost effective, and simple alternative to worm drive hose clips
- Fast and easy to install
- Ideal in narrow spaces
- Suitable for definitive fixation of connecting pipes
- To be assembled with simple ear clip pliers
- Extended clamping range

Applications

- For hoses that convey compressed air or fluid
- Original equipment manufacturing
- Maintenance repair and overhaul

Materials

W1	W2	W3	W4	W5
x			x	

Technical data & Ordering information

NORMACLAMP® EARCLIP DOUBLE					
Width	Designation	Clamping ranges		W1 Product No.	W4 Product No.
		in mm	in inches		
6	EARCLIP DOUBLE 5-7/6	5-7	3/16-1/4"	0110 7012 007	0110 7013 007
	EARCLIP DOUBLE 7-9/6	7-9	1/4-3/8"	0110 7012 009	0110 7013 009
6.5	EARCLIP DOUBLE 9-11/6.5	9-11	3/8-7/16"	0110 7012 011	0110 7013 011
	EARCLIP DOUBLE 10-12/6.5	10-12	3/8-1/2"	0110 7012 012	0110 7013 012
	EARCLIP DOUBLE 11-13/6.5	11-13	7/16-1/2"	0110 7012 013	0110 7013 013
7	EARCLIP DOUBLE 13-15/7	13-15	1/2-9/16"	0110 7012 015	0110 7013 015
	EARCLIP DOUBLE 14-17/7	14-17	9/16-11/16"	0110 7012 017	0110 7013 017
7.5	EARCLIP DOUBLE 15-18/7.5	15-18	9/16-11/16"	0110 7012 018	0110 7013 018
	EARCLIP DOUBLE 17-20/7.5	17-20	11/16-13/16"	0110 7012 020	0110 7013 020
8	EARCLIP DOUBLE 18-21/8	18-21	11/16-13/16"	0110 7012 021	0110 7013 021
	EARCLIP DOUBLE 20-23/8	20-23	13/16-15/16"	0110 7012 023	0110 7013 023
9	EARCLIP DOUBLE 22-25/9	22-25	7/8-1"	0110 7012 025	0110 7013 025
10	EARCLIP DOUBLE 23-27/10	23-27	15/16-1 11/16"	0110 7012 027	
	EARCLIP DOUBLE 25-28/10	25-28	1-1 1/8"	0110 7012 028	
	EARCLIP DOUBLE 28-31/10	28-31	1 1/8-1 1/4"	0110 7012 031	
	EARCLIP DOUBLE 31-34/10	31-34	1 1/4-1 5/16"	0110 7012 034	
	EARCLIP DOUBLE 34-37/10	34-37	1 5/16-1 7/16"	0110 7012 037	
	EARCLIP DOUBLE 37-40/10	37-40	1 7/16-1 9/16"	0110 7012 040	
	EARCLIP DOUBLE 40-43/10	40-43	1 9/16-1 11/16"	0110 7012 043	
	EARCLIP DOUBLE 43-46/10	43-46	1 11/16-1 13/16"	0110 7012 046	



Refer to page 197.

NORMACONNECT® – Pipe Connections

The perfect method of connecting pipes

When it comes to pipe connections, the industry and OEMs rely on **NORMACONNECT®** – the reliable solution that can be used with all kinds of different requirements, pipe materials and outer pipe diameters.



Our solution for connecting – FGR



FGR pipe couplings are a compact, economical and reliable means for connecting plain-ended pipes. They are suitable for joining plastic and metal pipes and especially pipes made from stainless steel. They can be used in mechanical engineering and construction, shipbuilding, civil engineering and in hydro technology, water supply and water treatment.

Supply pipes as well as exhaust pipes for solid, liquid or gaseous media can be joined easily and safely in a very short period of time even in narrow spaces. Thanks to the wide range of various types and sizes they are suitable for use both in standard and specialized applications.

Product benefits

FGR pipe couplings are an economical alternative to conventional pipe joining techniques for both plastic and metal pipes. All plain-ended pipes can be joined easily by hand. The ready-to-fit coupling is pushed over the pipe ends and then aligned and rotated to any fitting position. Tightening the two bolts alternately with a torque wrench is all it takes to make a safe fitting.



Range of applications

FGR pipe coupling is a reliable connection for thick- and thin-walled pipes which conforms to the latest DIN Standard 86128. Feed and return lines for liquids, gases and solids (for mechanical engineering and construction, civil

engineering, shipbuilding, pipeline construction, power stations, mining, filters, water technology, etc.) are joined quickly, easily and safely using FGR pipe couplings.



- No welding
- No necessity for prior pipe alignment or treatment of pipe ends
- Up to 80% time saving



- Compensates for pipe gaps up to 65 mm
- Compensates for axial movements up to 7.5 mm
- Compensates for misalignment up to 3 mm



- 70% less weight



- Compensates for angular deflection up to + or - 2° in total

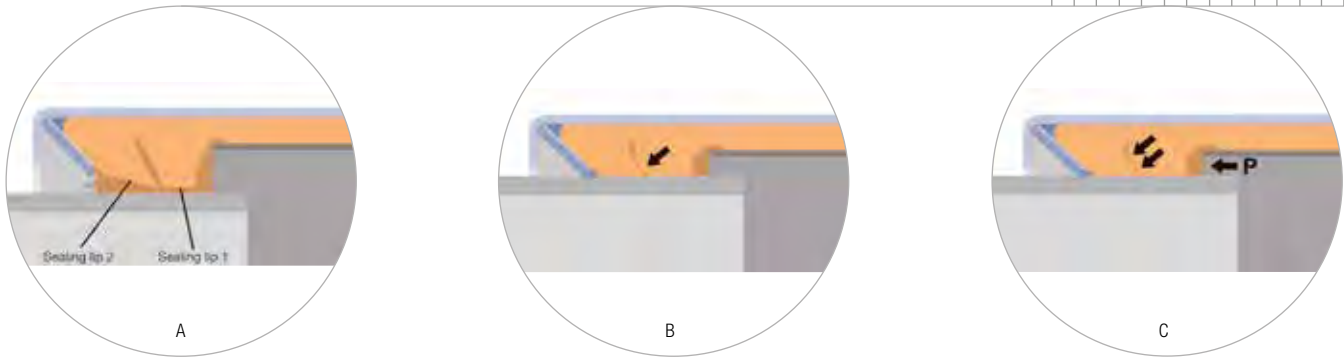

1. Double-lip sealing system

The patented double-lip sealing system of the FGR pipe couplings offers double safety. It provides maximum sealability at both low and high operating pressures (Fig. A).

When the bolts of the coupling are tightened, sealing lip 1 is pressed onto sealing lip 2, thus providing a highly reliable seal even under conditions of low pressure, vacuum or extreme loads acting on the joint (Fig. B).

The special sealing lip design means that when the internal pressure (P) increases, the sealing lips are pressed more firmly onto the pipe surface ensuring an even stronger seal (Fig. C).

2. Strip insert included as standard

All FGR pipe couplings are factory equipped with the strip insert as standard. The strip insert protects the sealing sleeve from increased mechanical and chemical loads. It also prevents the sealing sleeve from moisture expansion and allows larger gaps between the pipe ends to be connected.

Furthermore, it compensates for larger angular deflections and misalignment. With the strip insert the couplings can also be used for both vacuum and high pressure applications without any problems. The strip inserts are made from plastic material or stainless steel.

3. Heavy duty lock bars

For FGR pipe couplings we use lock bars with a larger diameter. Thus the rigidity of the coupling is increased and the engagement of the threaded end of the locking bolts is considerably improved.

4. Anchoring ring with conically stamped teeth

















The anchoring ring with conically stamped teeth indents into the pipe surface and provides safe and strong axial restraint. Owing to the special design the coupling is able to withstand even high vibration loads.

5. Protection ring

The protection ring protects the sealing sleeve from UV rays, fire, etc., and increases the flexural strength of the coupling.



Approvals

SHIPBUILDING		FLEX / FLEX E / RFP	GRIP / GRIP E / Grip E-FP / RFP	CombiGrip / CombiGrip E	PlastGrip / PlastGrip E	Rep E
ABS		•	•	•	•	
Bureau Veritas		•	•	•	•	
DNV-GL		•	•	•	•	
LRS		• ¹	• ¹	•	•	
CLASS NK		•	•	•	•	
RINA		•	•			
RMRS		•	•	•	•	
PRS		• ¹	• ¹			
KRS		•	•	•	•	
WATER SUPPLY & TREATMENT						
Elastomer guideline KTW/TZW W270		•	•	•	•	•
DVGW					• ²	
GOST		•	•	•	•	•
NSF		•	•	•	•	
DQS		•	•	•	•	•
GAS						
DVGW / GWI			•			
BAM			•		•	
SPECIAL APPROVALS						
DiBT / TÜV south. Germany			•			
BWB			• ³			
FDA		•	•	•	•	

¹ No approvals for RFP

² From 40.0 mm up to 160 mm

³ German approval for the German marine

Coupling types and suitable applications

Pipes to be joined	Size (mm)	Flex	Flex E	Flex 3	REP E from 35 mm
Metal + Metal	26.9 to 168.3	70 to 32 bar	70 to 32 bar	-	60 to 32 bar
	180.0 to 1219.2	50 to 7 bar	30 to 4 bar	-	30 to 4 bar
	326.0 to 2032.0	-	-	16.5 to 1.5 bar	-
Plastic + Plastic	26.9 to 168.3	16 bar	16 bar	-	16 bar
	180.0 to 1219.2	16 to 4 bar	16 to 4 bar	-	16 to 4 bar
Metal + Plastic	26.9 to 168.3	16 bar	16 bar	-	-
	180.0 to 1219.2	16 to 7 bar	16 to 7 bar	-	-

Larger diameters available on request

Pipes to be joined	Size (mm)	Grip	Grip E	Combi-Grip E	Combi-Grip	Plast-Grip E	Plast-Grip	Grip E-FP
Metal + Metal	26.9 to 168.3	70 to 32 bar	70 to 32 bar	-	-	-	-	60 to 32 bar
	180.0 to 419.0	-	20 to 2 bar	-	-	-	-	20 to 65 bar
	180.0 to 812.8	32 to 1 bar	-	-	-	-	-	-
Plastic + Plastic	40.0 to 168.3	-	-	-	-	16 bar	-	-
	200.0 to 406.4	-	-	-	-	-	16 to 6 bar	-
Metal + Plastic	38/40 to 160/168.3	16 bar	16 bar	16 bar	-	-	-	-
	200.0/204.0 to 406.0 /406.4	-	-	-	16 to 6 bar	-	-	-

Larger diameters available on request

Sealing sleeves

Areas of application & temperature resistance

Material of seal	NEW!		
	EPDM	NBR	FKM
Temperature range	-30 °C up to +125 °C OD 26.9 up to 168.3 mm -20 °C up to +80 °C OD > 180 mm	-20 °C up to +80 °C	-10 °C to + 150 °C*
Media	Drinking water Alcohols Compressed air Solids	Water Oils Gases (combustible) Fuels Hydrocarbons	Steam Several gases Hot water Ozone Oxygen Several acids** Several alkalis** Hydrocarbons

* Higher temperatures possible in some cases

** Case by case approval required. Please check with your sales representative

FGR Materials

Components and materials in accordance with AISI/BS. FGR pipe couplings are available in the materials W2, W4 and W5.

W2				
No.	Component	Flex/Flex E	Grip/Grip E	Plast Grip/ Plast Grip E
1	Housing with bridge	304/304 S31	304/304 S31	304/304 S31
2	Sealing sleeve	EPDM/NBR	EPDM/NBR	EPDM/NBR
3	Strip insert ¹⁾	316Ti/320 S31/PA-GR	316Ti/320 S31/PA-GR	316Ti/320 S31/PA-GR
4 A	Anchoring ring for metal pipes ²⁾	–	301/301 S21	–
4 A	Anchoring ring for plastic pipes ²⁾	–	–	PA-GF-NS ³⁾
4 B	Protection ring	316Ti/320 S31	–	–
5 + 6	Solid locking trunnions	AISI 1213	AISI 1213	AISI 1213
5 + 6	Hollow locking trunnions	AISI 1518	AISI 1518	AISI 1518
7	Locking bolts	10.9	10.9	10.9
8	Washer	A4-80/316	A4-80/316	A4-80/316

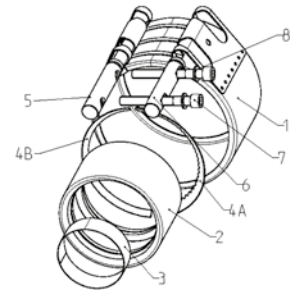

W4				
No.	Component	Flex/Flex E	Grip/Grip E	Plast Grip/ Plast Grip E
1	Housing with bridge	304/304 S31	304/304 S31	304/304 S31
2	Sealing sleeve	EPDM/NBR	EPDM/NBR	EPDM/NBR
3	Strip insert ¹⁾	316Ti/320 S31/PA-GR	316Ti/320 S31/PA-GR	316Ti/320 S31/PA-GR
4 A	Anchoring ring for metal pipes ²⁾	–	301/301 S21	–
4 A	Anchoring ring for plastic pipes ²⁾	–	–	PA-GF-NS ³⁾
4 B	Protection ring	316Ti/320 S31	316Ti/320 S31	–
5 + 6	Solid locking trunnions	316L	316L	1.4404
5 + 6	Hollow locking trunnions	316Ti/320 S31	316Ti/320 S31	1.4571
7	Locking bolts	A4-80/316	A4-80/316	A4-80
8	Washer	A4-80/316	A4-80/316	A4-80

¹⁾ PA-GF plastic strip inserts are only for pipe couplings used in shipbuilding applications.

²⁾ COMBI GRIP couplings are equipped with two different anchoring rings (1 x for the metal end, 1 x for the plastic end).

³⁾ PA-GF: PA reinforced with fiber glass; NS: new silver.

W5						
No.	Component	Flex/Flex E	Grip/Grip E	Combi Grip/ Combi Grip E	Plast Grip/ Plast Grip E	Rep E
1	Housing	316Ti/320 S31	316Ti/320 S31	316Ti/320 S31	316Ti/320 S31	316Ti/320 S31
2	Sealing sleeve	EPDM/NBR/FKM	EPDM/NBR/FKM	EPDM/NBR	EPDM/NBR	EPDM/NBR
3	Strip insert ¹⁾	316Ti/320 S31/PA-GR	316Ti/320 S31/PA-GR	316Ti/320 S31/PA-GR	316Ti/320 S31/PA-GR	316Ti/320 S31/PA-GR
4 A	Anchoring ring for metal pipes ²⁾	–	301/301 S21	301/301 S21 301/301 S21	–	–
4 A	Anchoring ring for plastic pipes ²⁾	–	–	PA-GF-NS ³⁾	PA-GF-NS ³⁾	–
4 B	Protection ring	316Ti/320 S31	–	–	–	–
5 + 6	Solid locking trunnions	316L	316L	316L	316L	316L
5 + 6	Hollow locking trunnions	316Ti/320 S31	316Ti/320 S31	316Ti/320 S31	316Ti/320 S31	316Ti/320 S31
7	Locking bolts	A4-80/316	A4-80/316	A4-80/316	A4-80/316	A4-80/316
8	Washer	A4-80/316	A4-80/316	A4-80/316	A4-80/316	A4-80/316

¹⁾ PA-GF plastic strip inserts are only for pipe couplings used in shipbuilding applications.

²⁾ COMBI GRIP couplings are equipped with two different anchoring rings (1 x for the metal end, 1 x for the plastic end).

³⁾ PA-GF: PA reinforced with fiber glass; NS: nickel and silver.

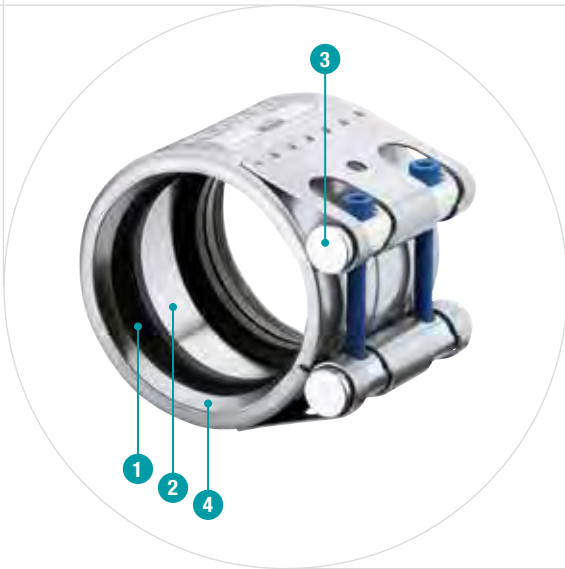

- 1 Double-lip sealing system
- 2 Standard strip insert
- 3 Lock bars
- 4 Protection ring

NEW!
Now also available with FKM sealing sleeve

NORMACONNECT®
NEW

The protective pipe coupling

NORMACONNECT® FLEX /FLEX E are axial non-restraint couplings. They are used for connecting metal pipes, stainless pipes, as well as concrete and plastic pipes. Sealing reliability is ensured even when NORMACONNECT® FLEX /FLEX E pipe couplings are mounted on pipes with or without a gap and also on compensated pipes.



Advantages at a glance

- Compensates for thermal elongation of the pipes
- Joining all kind of pipe materials is possible, e.g., for steel, plastic, cast iron, etc.

Information

- Sizes: 26.9 mm - 1219.1 mm
- Working pressure: 70.0 - 4.0 bar
- Material: AISI 304, AISI 316 Ti
- EPDM:
 Sizes from 26.9 mm up to 168.3 mm: - 30 °C up to + 125 °C
 Sizes > 180.0 mm: - 20 °C up to + 80 °C
- NBR: from - 20 °C up to + 80 °C
- FKM: -10 °C to + 150 °C (Higher temperatures possible in some cases.)



Materials

W1	W2	W3	W4	W5
	x		x	x

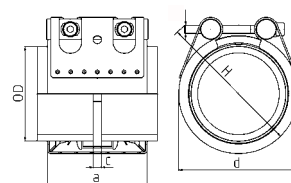
Technical data & Ordering information



Technical data & Ordering information

NORMACONNECT® FGR FLEX											
Ø (O.D.)	Designation	Clamping ranges	PN ¹ (MAWP ¹ from diameter 180)	WP ²	C max	Dimensions (approx.)			Weight (approx.)	Hex socket locking bolts	
		Odmin - Odmax	 [bar]	 [bar]	(mm)	a (mm)	d (mm)	H (mm)	(kg/pc.)	Thread	Tightening torque (Nm)
26.9	FLEX 26.9	26.4 - 27.5	16	70	3	67	50	70	0.39	M 8 SW 6	5
28.0	FLEX 28.0	27.5 - 28.5	16	70	3	67	50	70	0.39	M 8 SW 6	5
30.0	FLEX 30.0	29.5 - 30.6	16	70	3	67	50	70	0.39	M 8 SW 6	5
33.7	FLEX 33.7	33.0 - 34.3	16	60	3	67	55	75	0.4	M 8 SW 6	5
35.0	FLEX 35.0	34.5 - 35.6	16	60	8	63	55	75	0.54	M 8 SW 6	5
38.0	FLEX 38.0	37.5 - 38.6	16	60	8	63	60	80	0.54	M 8 SW 6	5
42.4	FLEX 42.4	41.7 - 43.0	16	50	8	63	65	85	0.56	M 8 SW 6	5
44.5	FLEX 44.5	44.0 - 45.1	16	50	8	63	65	85	0.56	M 8 SW 6	5
48.3	FLEX 48.3	47.6 - 50.5	16	50	8	63	70	90	0.58	M 8 SW 6	5
54.0	FLEX 54.0	53.3 - 54.6	16	50	17	78	75	95	0.76	M 8 SW 6	10
57.0	FLEX 57.0	56.3 - 57.7	16	50	17	78	80	100	0.76	M 8 SW 6	10
60.3	FLEX 60.3	59.5 - 61.0	16	40	17	78	85	105	0.77	M 8 SW 6	10
63.0	FLEX 63.0	62.2 - 63.9	16	40	17	78	85	105	0.77	M 8 SW 6	10
70.0	FLEX 70.0	69.0 - 71.0	16	40	25	98	90	110	1.37	M 8 SW 6	10
73.0	FLEX 73.0	72.1 - 73.8	16	40	25	98	95	115	1.39	M 8 SW 6	10
76.1	FLEX 76.1	75.2 - 77.0	16	35	25	98	100	120	1.39	M 8 SW 6	10
80.0	FLEX 80.0	79.0 - 80.8	16	35	25	98	100	120	1.43	M 8 SW 6	10
84.0	FLEX 84.0	83.0 - 85.0	16	35	25	98	105	125	1.46	M 8 SW 6	10
88.9	FLEX 88.9	87.0 - 89.9	16	35	25	98	110	130	1.47	M 8 SW 6	10
101.6	FLEX 101.6	100.4 - 102.8	16	35	25	98	125	145	1.61	M 8 SW 6	10
104.0	FLEX 104.0	102.8 - 106.1	16	35	25	98	125	145	1.62	M 8 SW 6	10
108.0	FLEX 108.0	106.8 - 109.2	16	35	25	98	130	150	1.64	M 8 SW 6	10
110.0	FLEX 110.0	108.8 - 111.4	16	35	25	98	130	150	1.69	M 8 SW 6	10
114.3	FLEX 114.3	113.0 - 115.5	16	35	25	98	135	155	1.69	M 8 SW 6	15
129.0	FLEX 129.0	127.6 - 131.1	16	32	35	113	155	185	2.41	M 10 SW 8	20
133.0	FLEX 133.0	131.5 - 134.4	16	32	35	113	160	190	2.43	M 10 SW 8	20
139.7	FLEX 139.7	138.1 - 141.6	16	32	35	113	165	195	2.5	M 10 SW 8	25
141.3	FLEX 141.3	139.6 - 142.8	16	32	35	113	170	200	2.5	M 10 SW 8	25
154.0	FLEX 154.0	152.3 - 156.1	16	32	35	113	180	210	2.62	M 10 SW 8	30
159.0	FLEX 159.0	157.3 - 160.7	16	32	35	113	185	215	2.69	M 10 SW 8	30
168.3	FLEX 168.3	166.5 - 170.1	16	32	35	113	195	225	2.75	M 10 SW 8	30
180.0	FLEX 180.0	178.0 - 182.0	23.5	50.0	35	141	210	240	5.4	M 12 SW 10	35
193.7	FLEX 193.7	192.0 - 196.0	23.5	46.0	35	141	225	255	5.6	M 12 SW 10	35
206.0	FLEX 206.0	202.0 - 208.0	20.0	43.0	35	141	240	270	5.8	M 12 SW 10	35
219.0	FLEX 219.0	216.0 - 221.0	18.0	40.5	35	141	250	280	6.0	M 12 SW 10	35
225.0	FLEX 225.0	222.0 - 227.0	18.0	40.0	35	141	255	285	6.1	M 12 SW 10	35
229.9	FLEX 229.9	228.0 - 232.0	18.0	39.0	35	141	260	290	6.2	M 12 SW 10	35
244.5	FLEX 244.5	242.0 - 247.0	18.0	37.0	35	141	275	305	6.4	M 12 SW 10	35
254.0	FLEX 254.0	250.0 - 256.0	18.0	35.5	35	141	285	315	6.5	M 12 SW 10	35
267.0	FLEX 267.0	264.0 - 269.0	18.0	33.5	35	141	300	330	6.7	M 12 SW 10	35
273.0	FLEX 273.0	270.0 - 275.0	17.0	33.0	35	141	305	335	6.8	M 12 SW 10	35
306.0	FLEX 306.0	302.0 - 308.0	15.0	29.0	35	141	340	370	7.4	M 12 SW 10	35
323.9	FLEX 323.9	320.0 - 327.0	15.0	28.0	35	141	355	385	7.6	M 12 SW 10	35
326.0	FLEX 326.0	322.0 - 329.0	13.0	27.5	35	141	360	390	7.7	M 12 SW 10	35
355.6	FLEX 355.6	352.0 - 359.0	13.0	25.0	35	141	390	420	8.1	M 12 SW 10	35
406.4	FLEX 406.4	402.0 - 410.0	10.0	22.0	35	141	440	470	8.9	M 12 SW 10	35
429.0	FLEX 429.0	426.0 - 431.0	7.5	21.0	35	141	460	490	9.3	M 12 SW 10	40
442.0	FLEX 442.0	439.0 - 444.0	7.5	20.0	35	141	475	505	9.5	M 12 SW 10	40
457.2	FLEX 457.2	454.0 - 459.0	7.5	19.5	35	141	490	520	9.7	M 12 SW 10	40
508.0	FLEX 508.0	505.0 - 510.0	7.5	17.0	35	141	540	570	10.5	M 12 SW 10	40
531.0	FLEX 531.0	528.0 - 534.0	7.5	16.0	35	141	565	595	10.9	M 12 SW 10	50
558.8	FLEX 558.8	556.0 - 562.0	7.5	15.5	35	141	590	620	11.3	M 12 SW 10	50
609.6	FLEX 609.6	606.0 - 613.0	6.0	14.0	35	141	640	670	12.1	M 12 SW 10	50
634.0	FLEX 634.0	631.0 - 637.0	5.0	13.5	35	141	665	695	12.5	M 12 SW 10	50
711.2	FLEX 711.2	707.0 - 715.0	5.0	12.0	35	141	745	775	13.7	M 12 SW 10	50
762.0	FLEX 762.0	758.0 - 766.0	4.5	11.0	35	141	795	885	14.5	M 12 SW 10	50
812.8	FLEX 812.8	808.0 - 817.0	4.5	10.5	35	141	845	935	17.2	M 12 SW 10	50
914.4	FLEX 914.4	909.0 - 919.0	3.3	9.5	35	141	945	1035	18.8	M 12 SW 10	60
1016.0	FLEX 1016.0	1013.0 - 1019.0	3.3	8.0	35	141	1050	1140	20.4	M 12 SW 10	60
1117.5	FLEX 1117.5	1114.0 - 1120.0	3.3	7.5	35	141	1150	1240	22.0	M 12 SW 10	60
1219.2	FLEX 1219.2	1216.0 - 1222.0	3.3	7.0	35	141	1250	1340	23.6	M 12 SW 10	60

Coupling sizes >800 mm are in 2-parts design! Sizes > 1219.2 on request

PN¹ (Nominal Pressure) is the max. admissible working pressure in shipbuilding, based on a safety factor of ≥ 4.

MAWP¹ (Maximum Allowable Working Pressure) is the max. admissible working pressure in shipbuilding, based on a safety factor of ≥ 4.

WP² is the max. working pressure in industrial applications, with a safety factor as per NORMA specification.

Technical data & Ordering information

NORMACONNECT® FGR FLEX								
Ø (O.D.)	Designation	W2 Product No.		W4 Product No.		W5 Product No.		
		EPDM	NBR	EPDM	NBR	EPDM	NBR	FKM
26.9	FLEX 26.9	0573 9100 026	0573 8400 026	0573 9200 026	0573 8500 026			
28.0	FLEX 28.0	0573 9100 028	0573 8400 028	0573 9200 028	0573 8500 028			
30.0	FLEX 30.0	0573 9100 030	0573 8400 030	0573 9200 030	0573 8500 030			
33.7	FLEX 33.7	0573 9100 033	0573 8400 033	0573 9200 033	0573 8500 033			0573 9900 033
35.0	FLEX 35.0	0573 9100 035	0573 8400 035	0573 9200 035	0573 8500 035			
38.0	FLEX 38.0	0573 9100 038	0573 8400 038	0573 9200 038	0573 8500 038			0573 9900 038
42.4	FLEX 42.4	0573 9100 042	0573 8400 042	0573 9200 042	0573 8500 042			0573 9900 042
44.5	FLEX 44.5	0573 9100 044	0573 8400 044	0573 9200 044	0573 8500 044			
48.3	FLEX 48.3	0573 9100 048	0573 8400 048	0573 9200 048	0573 8500 048			0573 9900 048
54.0	FLEX 54.0	0573 9100 054	0573 8400 054	0573 9200 054	0573 8500 054			
57.0	FLEX 57.0	0573 9100 057	0573 8400 057	0573 9200 057	0573 8500 057			0573 9900 057
60.3	FLEX 60.3	0573 9100 060	0573 8400 060	0573 9200 060	0573 8500 060			0573 9900 060
63.0	FLEX 63.0	0573 9100 063	0573 8400 063	0573 9200 063	0573 8500 063			0573 9900 063
70.0	FLEX 70.0	0573 9100 070	0573 8400 070	0573 9200 070	0573 8500 070			
73.0	FLEX 73.0	0573 9100 073	0573 8400 073	0573 9200 073	0573 8500 073			
76.1	FLEX 76.1	0573 9100 076	0573 8400 076	0573 9200 076	0573 8500 076			0573 9900 076
80.0	FLEX 80.0	0573 9100 080	0573 8400 080	0573 9200 080	0573 8500 080			
84.0	FLEX 84.0	0573 9100 084	0573 8400 084	0573 9200 084	0573 8500 084			
88.9	FLEX 88.9	0573 9100 088	0573 8400 088	0573 9200 088	0573 8500 088			0573 9900 088
101.6	FLEX 101.6	0573 9100 101	0573 8400 101	0573 9200 101	0573 8500 101			
104.0	FLEX 104.0	0573 9100 104	0573 8400 104	0573 9200 104	0573 8500 104			
108.0	FLEX 108.0	0573 9100 108	0573 8400 108	0573 9200 108	0573 8500 108			
110.0	FLEX 110.0	0573 9100 110	0573 8400 110	0573 9200 110	0573 8500 110			
114.3	FLEX 114.3	0573 9100 114	0573 8400 114	0573 9200 114	0573 8500 114			0573 9900 114
129.0	FLEX 129.0	0573 9100 129	0573 8400 129	0573 9200 129	0573 8500 129			0573 9900 129
133.0	FLEX 133.0	0573 9100 133	0573 8400 133	0573 9200 133	0573 8500 133			
139.7	FLEX 139.7	0573 9100 139	0573 8400 139	0573 9200 139	0573 8500 139			0573 9900 139
141.3	FLEX 141.3	0573 9100 141	0573 8400 141	0573 9200 141	0573 8500 141			
154.0	FLEX 154.0	0573 9100 154	0573 8400 154	0573 9200 154	0573 8500 154			
159.0	FLEX 159.0	0573 9100 159	0573 8400 159	0573 9200 159	0573 8500 159			
168.3	FLEX 168.3	0573 9100 168	0573 8400 168	0573 9200 168	0573 8500 168			0573 9900 168
180.0	FLEX 180.0	0575 8140 ...	0575 8440 ...	0575 8240 ...	0575 8540 ...	0575 8340 ...	0575 8640 ...	
193.7	FLEX 193.7	0575 8140 ...	0575 8440 ...	0575 8240 ...	0575 8540 ...	0575 8340 ...	0575 8640 ...	
206.0	FLEX 206.0	0575 8140 ...	0575 8440 ...	0575 8240 ...	0575 8540 ...	0575 8340 ...	0575 8640 ...	
219.0	FLEX 219.0	0575 8140 ...	0575 8440 ...	0575 8240 ...	0575 8540 ...	0575 8340 ...	0575 8640 ...	
225.0	FLEX 225.0	0575 8140 ...	0575 8440 ...	0575 8240 ...	0575 8540 ...	0575 8340 ...	0575 8640 ...	
229.9	FLEX 229.9	0575 8140 ...	0575 8440 ...	0575 8240 ...	0575 8540 ...	0575 8340 ...	0575 8640 ...	
244.5	FLEX 244.5	0575 8140 ...	0575 8440 ...	0575 8240 ...	0575 8540 ...	0575 8340 ...	0575 8640 ...	
254.0	FLEX 254.0	0575 8140 ...	0575 8440 ...	0575 8240 ...	0575 8540 ...	0575 8340 ...	0575 8640 ...	
267.0	FLEX 267.0	0575 8140 ...	0575 8440 ...	0575 8240 ...	0575 8540 ...	0575 8340 ...	0575 8640 ...	
273.0	FLEX 273.0	0575 8140 ...	0575 8440 ...	0575 8240 ...	0575 8540 ...	0575 8340 ...	0575 8640 ...	
306.0	FLEX 306.0	0575 8140 ...	0575 8440 ...	0575 8240 ...	0575 8540 ...	0575 8340 ...	0575 8640 ...	
323.9	FLEX 323.9	0575 8140 ...	0575 8440 ...	0575 8240 ...	0575 8540 ...	0575 8340 ...	0575 8640 ...	
326.0	FLEX 326.0	0575 8140 ...	0575 8440 ...	0575 8240 ...	0575 8540 ...	0575 8340 ...	0575 8640 ...	
355.6	FLEX 355.6	0575 8140 ...	0575 8440 ...	0575 8240 ...	0575 8540 ...	0575 8340 ...	0575 8640 ...	
406.4	FLEX 406.4	0575 8140 ...	0575 8440 ...	0575 8240 ...	0575 8540 ...	0575 8340 ...	0575 8640 ...	
429.0	FLEX 429.0	0575 8140 ...	0575 8440 ...	0575 8240 ...	0575 8540 ...	0575 8340 ...	0575 8640 ...	
442.0	FLEX 442.0	0575 8140 ...	0575 8440 ...	0575 8240 ...	0575 8540 ...	0575 8340 ...	0575 8640 ...	
457.2	FLEX 457.2	0575 8140 ...	0575 8440 ...	0575 8240 ...	0575 8540 ...	0575 8340 ...	0575 8640 ...	
508.0	FLEX 508.0	0575 8140 ...	0575 8440 ...	0575 8240 ...	0575 8540 ...	0575 8340 ...	0575 8640 ...	
531.0	FLEX 531.0	0575 8140 ...	0575 8440 ...	0575 8240 ...	0575 8540 ...	0575 8340 ...	0575 8640 ...	
558.8	FLEX 558.8	0575 8140 ...	0575 8440 ...	0575 8240 ...	0575 8540 ...	0575 8340 ...	0575 8640 ...	
609.6	FLEX 609.6	0575 8140 ...	0575 8440 ...	0575 8240 ...	0575 8540 ...	0575 8340 ...	0575 8640 ...	
634.0	FLEX 634.0	0575 8140 ...	0575 8440 ...	0575 8240 ...	0575 8540 ...	0575 8340 ...	0575 8640 ...	
711.2	FLEX 711.2	0575 8140 ...	0575 8440 ...	0575 8240 ...	0575 8540 ...	0575 8340 ...	0575 8640 ...	
762.0	FLEX 762.0	0575 8140 ...	0575 8440 ...	0575 8240 ...	0575 8540 ...	0575 8340 ...	0575 8640 ...	
812.8	FLEX 812.8	0575 8148 ...	0575 8448 ...	0575 8248 ...	0575 8548 ...	0575 8348 ...	0575 8648 ...	
914.4	FLEX 914.4	0575 8148 ...	0575 8448 ...	0575 8248 ...	0575 8548 ...	0575 8348 ...	0575 8648 ...	
1016.0	FLEX 1016.0	0575 8148 ...	0575 8448 ...	0575 8248 ...	0575 8548 ...	0575 8348 ...	0575 8648 ...	
1117.5	FLEX 1117.5	0575 8148 ...	0575 8448 ...	0575 8248 ...	0575 8548 ...	0575 8348 ...	0575 8648 ...	
1219.2	FLEX 1219.2	0575 8148 ...	0575 8448 ...	0575 8248 ...	0575 8548 ...	0575 8348 ...	0575 8648 ...	

... = Ø without decimals in mm

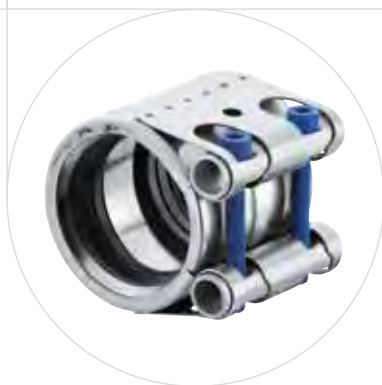

NORMACONNECT® FLEX E an axial non-restraint coupling. It is used for connecting metal pipes, stainless pipes, as well as concrete and plastic pipes. This is a hollow trunnions version.

Material
W2, W4, W5

NORMACONNECT® FGR FLEX E

Ø (O.D.)	Designation	Clamping ranges O _{dmin} - O _{dmax}	PN ¹ (MAWP ¹ from Ø 180)	WP ²	C max (mm)	Dimensions (approx.)			Weight (approx.) (kg/pc.)	Hex socket locking bolts	
						a (mm)	d (mm)	H (mm)		Thread	Tightening torque (Nm)
26.9	FLEX E 26.9	26.4-27.5	16	70	3	67	50	70	0.31	M 8 SW 6	5
28.0	FLEX E 28.0	27.5-28.5	16	70	3	67	50	70	0.31	M 8 SW 6	5
30.0	FLEX E 30.0	29.5-30.6	16	70	3	67	50	70	0.31	M 8 SW 6	5
33.7	FLEX E 33.7	33.0-34.3	16	60	3	67	55	75	0.32	M 8 SW 6	5
35.0	FLEX E 35.0	34.5-35.6	16	60	8	63	55	75	0.43	M 8 SW 6	5
38.0	FLEX E 38.0	37.5-38.6	16	60	8	63	60	80	0.43	M 8 SW 6	5
42.4	FLEX E 42.4	41.7-43.0	16	50	8	63	65	85	0.44	M 8 SW 6	5
44.5	FLEX E 44.5	44.0-45.1	16	50	8	63	65	85	0.45	M 8 SW 6	5
48.3	FLEX E 48.3	47.6-50.5	16	50	8	63	70	90	0.46	M 8 SW 6	5
54.0	FLEX E 54.0	53.3-54.6	16	50	17	78	75	95	0.60	M 8 SW 6	10
57.0	FLEX E 57.0	56.3-57.7	16	50	17	78	80	100	0.61	M 8 SW 6	10
60.3	FLEX E 60.3	59.5-61.0	16	40	17	78	85	105	0.62	M 8 SW 6	10
63.0	FLEX E 63.0	62.2-63.9	16	40	17	78	85	105	0.62	M 8 SW 6	10
70.0	FLEX E 70.0	69.0-71.0	16	40	25	98	90	110	1.16	M 8 SW 6	10
73.0	FLEX E 73.0	72.1-73.8	16	40	25	98	95	115	1.18	M 8 SW 6	10
76.1	FLEX E 76.1	75.2-77.0	16	35	25	98	100	120	1.18	M 8 SW 6	10
80.0	FLEX E 80.0	79.0-80.8	16	35	25	98	100	120	1.21	M 8 SW 6	10
84.0	FLEX E 84.0	83.0-85.0	16	35	25	98	105	125	1.24	M 8 SW 6	10
88.9	FLEX E 88.9	87.0-89.9	16	35	25	98	110	130	1.26	M 8 SW 6	10
101.6	FLEX E 101.6	100.4-102.8	16	35	25	98	125	145	1.39	M 8 SW 6	10
104.0	FLEX E 104.0	102.8-106.1	16	35	25	98	125	145	1.40	M 8 SW 6	10
108.0	FLEX E 108.0	106.8-109.2	16	35	25	98	130	150	1.42	M 8 SW 6	10
110.0	FLEX E 110.0	108.8-111.4	16	35	25	98	130	150	1.47	M 8 SW 6	10
114.3	FLEX E 114.3	113.0-115.5	16	35	25	98	135	155	1.47	M 8 SW 6	15
129.0	FLEX E 129.0	127.6-131.1	16	32	35	113	155	185	2.10	M 10 SW 8	20
133.0	FLEX E 133.0	131.5-134.4	16	32	35	113	160	190	2.13	M 10 SW 8	20
139.7	FLEX E 139.7	138.1-141.6	16	32	35	113	165	195	2.19	M 10 SW 8	25
141.3	FLEX E 141.3	139.6-142.8	16	32	35	113	170	200	2.19	M 10 SW 8	25
154.0	FLEX E 154.0	152.3-156.1	16	32	35	113	180	210	2.31	M 10 SW 8	30
159.0	FLEX E 159.0	157.3-160.7	16	32	35	113	185	215	2.38	M 10 SW 8	30
168.3	FLEX E 168.3	166.5 - 170.1	16	32	35	113	195	225	2.43	M 10 SW 8	30
180.0	FLEX E 180.0	178.0 - 182.0	13.5	30.0	35	139	210	240	4.0	M 12 SW 10	25
193.7	FLEX E 193.7	192.0 - 196.0	13.5	28.0	35	139	225	255	4.1	M 12 SW 10	25
206.0	FLEX E 206.0	202.0 - 208.0	13.5	26.5	35	139	240	270	4.3	M 12 SW 10	25
219.0	FLEX E 219.0	216.0 - 221.0	13.5	23.0	35	139	250	280	4.4	M 12 SW 10	25
225.0	FLEX E 225.0	222.0 - 227.0	12.0	23.0	35	139	255	285	4.5	M 12 SW 10	25
229.9	FLEX E 229.9	228.0 - 232.0	12.0	23.0	35	139	260	290	4.5	M 12 SW 10	25
244.5	FLEX E 244.5	242.0 - 247.0	12.0	22.0	35	139	275	305	4.7	M 12 SW 10	25
254.0	FLEX E 254.0	250.0 - 256.0	12.0	21.0	35	139	285	315	4.8	M 12 SW 10	25
267.0	FLEX E 267.0	264.0 - 269.0	12.0	20.0	35	139	300	330	5.0	M 12 SW 10	25
273.0	FLEX E 273.0	270.0 - 275.0	12.0	20.0	35	139	305	335	5.1	M 12 SW 10	25
306.0	FLEX E 306.0	302.0 - 308.0	9.0	17.5	35	139	340	370	5.5	M 12 SW 10	25
323.9	FLEX E 323.9	320.0 - 327.0	9.0	17.5	35	139	355	385	5.7	M 12 SW 10	25
326.0	FLEX E 326.0	322.0 - 329.0	9.0	16.5	35	139	360	390	5.7	M 12 SW 10	25
355.6	FLEX E 355.6	352.0 - 359.0	9.0	15.0	35	139	390	420	6.0	M 12 SW 10	25
406.4	FLEX E 406.4	402.0 - 410.0	7.5	14.0	35	139	440	470	6.7	M 12 SW 10	25
429.0	FLEX E 429.0	426.0 - 431.0	5.5	13.0	35	139	460	490	6.9	M 12 SW 10	40
442.0	FLEX E 442.0	439.0 - 444.0	5.5	13.0	35	139	475	505	7.1	M 12 SW 10	40
457.2	FLEX E 457.2	454.0 - 459.0	5.5	12.0	35	139	490	520	7.3	M 12 SW 10	40
508.0	FLEX E 508.0	505.0 - 510.0	5.5	11.0	35	139	540	570	7.9	M 12 SW 10	40
531.0	FLEX E 531.0	528.0 - 534.0	5.5	10.5	35	139	565	595	8.1	M 12 SW 10	40
558.8	FLEX E 558.8	556.0 - 562.0	5.5	10.0	35	139	590	620	8.5	M 12 SW 10	40
609.6	FLEX E 609.6	606.0 - 613.0	4.5	9.0	35	139	640	670	9.1	M 12 SW 10	40
634.0	FLEX E 634.0	631.0 - 637.0	4.5	8.0	35	139	665	695	9.4	M 12 SW 10	40
711.2	FLEX E 711.2	707.0 - 715.0	4.0	7.0	35	139	745	775	10.3	M 12 SW 10	40
762.0	FLEX E 762.0	758.0 - 766.0	3.2	7.0	35	139	795	885	10.9	M 12 SW 10	40
812.8	FLEX E 812.8	808.0 - 817.0	3.2	6.5	35	139	845	935	12.8	M 12 SW 10	40
914.4	FLEX E 914.4	909.0 - 919.0	2.0	5.5	35	139	945	1035	14.0	M 12 SW 10	45
1016.0	FLEX E 1016.0	1013.0 - 1019.0	2.0	5.0	35	139	1050	1140	15.2	M 12 SW 10	45
1117.5	FLEX E 1117.5	1114.0 - 1120.0	2.0	4.5	35	139	1150	1240	16.4	M 12 SW 10	50
1219.2	FLEX E 1219.2	1216.0 - 1222.0	2.0	4.0	35	139	1250	1340	17.7	M 12 SW 10	50

Coupling sizes >800 mm are in 2-parts design! Sizes > 1219.2 on request

PN¹ (Nominal Pressure) is the max. admissible working pressure in shipbuilding, based on a safety factor of ≥ 4.

MAWP¹ (Maximum Allowable Working Pressure) is the max. admissible working pressure in shipbuilding, based on a safety factor of ≥ 4.

WP² is the max. working pressure in industrial applications, with a safety factor as per NORMA specification.

Technical data & Ordering information

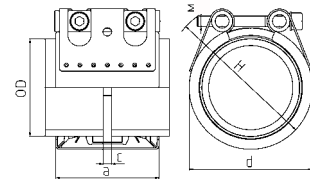

NORMACONNECT® FGR FLEX E							
Ø (O.D.)	Designation	W2 Product No.		W4 Product No.		W5 Product No.	
		EPDM	NBR	EPDM	NBR	EPDM	NBR
26.9	FLEX E 26.9	0582 9100 026	0582 8400 026	0582 9200 026	0582 8500 026	0582 9300 026	0582 8600 026
28.0	FLEX E 28.0	0582 9100 028	0582 8400 028	0582 9200 028	0582 8500 028	0582 9300 028	0582 8600 028
30.0	FLEX E 30.0	0582 9100 030	0582 8400 030	0582 9200 030	0582 8500 030	0582 9300 030	0582 8600 030
33.7	FLEX E 33.7	0582 9100 033	0582 8400 033	0582 9200 033	0582 8500 033	0582 9300 033	0582 8600 033
35.0	FLEX E 35.0	0582 9100 035	0582 8400 035	0582 9200 035	0582 8500 035	0582 9300 035	0582 8600 035
38.0	FLEX E 38.0	0582 9100 038	0582 8400 038	0582 9200 038	0582 8500 038	0582 9300 038	0582 8600 038
42.4	FLEX E 42.4	0582 9100 042	0582 8400 042	0582 9200 042	0582 8500 042	0582 9300 042	0582 8600 042
44.5	FLEX E 44.5	0582 9100 044	0582 8400 044	0582 9200 044	0582 8500 044	0582 9300 044	0582 8600 044
48.3	FLEX E 48.3	0582 9100 048	0582 8400 048	0582 9200 048	0582 8500 048	0582 9300 048	0582 8600 048
54.0	FLEX E 54.0	0582 9100 054	0582 8400 054	0582 9200 054	0582 8500 054	0582 9300 054	0582 8600 054
57.0	FLEX E 57.0	0582 9100 057	0582 8400 057	0582 9200 057	0582 8500 057	0582 9300 057	0582 8600 057
60.3	FLEX E 60.3	0582 9100 060	0582 8400 060	0582 9200 060	0582 8500 060	0582 9300 060	0582 8600 060
63.0	FLEX E 63.0	0582 9100 063	0582 8400 063	0582 9200 063	0582 8500 063	0582 9300 063	0582 8600 063
70.0	FLEX E 70.0	0582 9100 070	0582 8400 070	0582 9200 070	0582 8500 070	0582 9300 070	0582 8600 070
73.0	FLEX E 73.0	0582 9100 073	0582 8400 073	0582 9200 073	0582 8500 073	0582 9300 073	0582 8600 073
76.1	FLEX E 76.1	0582 9100 076	0582 8400 076	0582 9200 076	0582 8500 076	0582 9300 076	0582 8600 076
80.0	FLEX E 80.0	0582 9100 080	0582 8400 080	0582 9200 080	0582 8500 080	0582 9300 080	0582 8600 080
84.0	FLEX E 84.0	0582 9100 084	0582 8400 084	0582 9200 084	0582 8500 084	0582 9300 084	0582 8600 084
88.9	FLEX E 88.9	0582 9100 088	0582 8400 088	0582 9200 088	0582 8500 088	0582 9300 088	0582 8600 088
101.6	FLEX E 101.6	0582 9100 101	0582 8400 101	0582 9200 101	0582 8500 101	0582 9300 101	0582 8600 101
104.0	FLEX E 104.0	0582 9100 104	0582 8400 104	0582 9200 104	0582 8500 104	0582 9300 104	0582 8600 104
108.0	FLEX E 108.0	0582 9100 108	0582 8400 108	0582 9200 108	0582 8500 108	0582 9300 108	0582 8600 108
110.0	FLEX E 110.0	0582 9100 110	0582 8400 110	0582 9200 110	0582 8500 110	0582 9300 110	0582 8600 110
114.3	FLEX E 114.3	0582 9100 114	0582 8400 114	0582 9200 114	0582 8500 114	0582 9300 114	0582 8600 114
129.0	FLEX E 129.0	0582 9100 129	0582 8400 129	0582 9200 129	0582 8500 129	0582 9300 129	0582 8600 129
133.0	FLEX E 133.0	0582 9100 133	0582 8400 133	0582 9200 133	0582 8500 133	0582 9300 133	0582 8600 133
139.7	FLEX E 139.7	0582 9100 139	0582 8400 139	0582 9200 139	0582 8500 139	0582 9300 139	0582 8600 139
141.3	FLEX E 141.3	0582 9100 141	0582 8400 141	0582 9200 141	0582 8500 141	0582 9300 141	0582 8600 141
154.0	FLEX E 154.0	0582 9100 154	0582 8400 154	0582 9200 154	0582 8500 154	0582 9300 154	0582 8600 154
159.0	FLEX E 159.0	0582 9100 159	0582 8400 159	0582 9200 159	0582 8500 159	0582 9300 159	0582 8600 159
168.3	FLEX E 168.3	0582 9100 168	0582 8400 168	0582 9200 168	0582 8500 168	0582 9300 168	0582 8600 168
180.0	FLEX E 180.0	0583 8120 ...	0583 8420 ...	0583 8220 ...	0583 8520 ...	0583 8320 ...	0583 8620 ...
193.7	FLEX E 193.7	0583 8120 ...	0583 8420 ...	0583 8220 ...	0583 8520 ...	0583 8320 ...	0583 8620 ...
206.0	FLEX E 206.0	0583 8120 ...	0583 8420 ...	0583 8220 ...	0583 8520 ...	0583 8320 ...	0583 8620 ...
219.0	FLEX E 219.0	0583 8120 ...	0583 8420 ...	0583 8220 ...	0583 8520 ...	0583 8320 ...	0583 8620 ...
225.0	FLEX E 225.0	0583 8120 ...	0583 8420 ...	0583 8220 ...	0583 8520 ...	0583 8320 ...	0583 8620 ...
229.9	FLEX E 229.9	0583 8120 ...	0583 8420 ...	0583 8220 ...	0583 8520 ...	0583 8320 ...	0583 8620 ...
244.5	FLEX E 244.5	0583 8120 ...	0583 8420 ...	0583 8220 ...	0583 8520 ...	0583 8320 ...	0583 8620 ...
254.0	FLEX E 254.0	0583 8120 ...	0583 8420 ...	0583 8220 ...	0583 8520 ...	0583 8320 ...	0583 8620 ...
267.0	FLEX E 267.0	0583 8120 ...	0583 8420 ...	0583 8220 ...	0583 8520 ...	0583 8320 ...	0583 8620 ...
273.0	FLEX E 273.0	0583 8120 ...	0583 8420 ...	0583 8220 ...	0583 8520 ...	0583 8320 ...	0583 8620 ...
306.0	FLEX E 306.0	0583 8120 ...	0583 8420 ...	0583 8220 ...	0583 8520 ...	0583 8320 ...	0583 8620 ...
323.9	FLEX E 323.9	0583 8120 ...	0583 8420 ...	0583 8220 ...	0583 8520 ...	0583 8320 ...	0583 8620 ...
326.0	FLEX E 326.0	0583 8120 ...	0583 8420 ...	0583 8220 ...	0583 8520 ...	0583 8320 ...	0583 8620 ...
355.6	FLEX E 355.6	0583 8120 ...	0583 8420 ...	0583 8220 ...	0583 8520 ...	0583 8320 ...	0583 8620 ...
406.4	FLEX E 406.4	0583 8120 ...	0583 8420 ...	0583 8220 ...	0583 8520 ...	0583 8320 ...	0583 8620 ...
429.0	FLEX E 429.0	0583 8120 ...	0583 8420 ...	0583 8220 ...	0583 8520 ...	0583 8320 ...	0583 8620 ...
442.0	FLEX E 442.0	0583 8120 ...	0583 8420 ...	0583 8220 ...	0583 8520 ...	0583 8320 ...	0583 8620 ...
457.2	FLEX E 457.2	0583 8120 ...	0583 8420 ...	0583 8220 ...	0583 8520 ...	0583 8320 ...	0583 8620 ...
508.0	FLEX E 508.0	0583 8120 ...	0583 8420 ...	0583 8220 ...	0583 8520 ...	0583 8320 ...	0583 8620 ...
531.0	FLEX E 531.0	0583 8120 ...	0583 8420 ...	0583 8220 ...	0583 8520 ...	0583 8320 ...	0583 8620 ...
558.8	FLEX E 558.8	0583 8120 ...	0583 8420 ...	0583 8220 ...	0583 8520 ...	0583 8320 ...	0583 8620 ...
609.6	FLEX E 609.6	0583 8120 ...	0583 8420 ...	0583 8220 ...	0583 8520 ...	0583 8320 ...	0583 8620 ...
634.0	FLEX E 634.0	0583 8120 ...	0583 8420 ...	0583 8220 ...	0583 8520 ...	0583 8320 ...	0583 8620 ...
711.2	FLEX E 711.2	0583 8120 ...	0583 8420 ...	0583 8220 ...	0583 8520 ...	0583 8320 ...	0583 8620 ...
762.0	FLEX E 762.0	0583 8120 ...	0583 8420 ...	0583 8220 ...	0583 8520 ...	0583 8320 ...	0583 8620 ...
812.8	FLEX E 812.8	0583 8128 ...	0583 8428 ...	0583 8228 ...	0583 8528 ...	0583 8328 ...	0583 8628 ...
914.4	FLEX E 914.4	0583 8128 ...	0583 8428 ...	0583 8228 ...	0583 8528 ...	0583 8328 ...	0583 8628 ...
1016.0	FLEX E 1016.0	0583 8128 ...	0583 8428 ...	0583 8228 ...	0583 8528 ...	0583 8328 ...	0583 8628 ...
1117.5	FLEX E 1117.5	0583 8128 ...	0583 8428 ...	0583 8228 ...	0583 8528 ...	0583 8328 ...	0583 8628 ...
1219.2	FLEX E 1219.2	0583 8128 ...	0583 8428 ...	0583 8228 ...	0583 8528 ...	0583 8328 ...	0583 8628 ...

... = Ø without decimals in mm



- 1 Double-lip sealing system
- 2 Standard strip insert
- 3 Lock bars



NORMACONNECT® FLEX 3 pipe coupling with extra wide band width of 211 mm

The pipe coupling with extra wide band

NORMACONNECT® FLEX 3 featuring an extra wide band is an axial non-restraint coupling used to connect metal and/or plastic pipes quickly and safely.



Advantages at a glance

- Easy and quick to assemble
- Pipe end distance up to 65 mm possible
- Compensation of misalignment, angular deflection up to 4° possible

Information

- Sizes: from 326.0 mm to 2032.0 mm
- Working pressure: 16.5 bar - 1.5 bar
- Solid trunnions
- 2 closure units from size > 800.0 mm
- Material: AISI 316 Ti
- EPDM: from - 20 °C up to + 80 °C
- NBR: from - 20 °C up to + 80 °C

Materials

W1	W2	W3	W4	W5
				x

Technical data & Ordering information

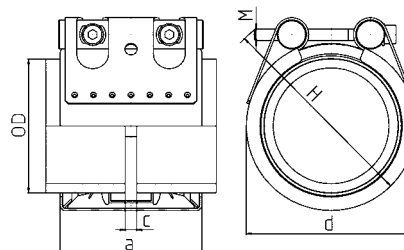

Technical data & Ordering information

NORMACONNECT® FGR FLEX 3												
Ø (O.D.)	Designation	Clamping ranges	WP ¹	C max	Dimensions (approx.)			Weight (approx.)	Hex socket locking bolts		W5 Product No.	
		O _{dmin} - O _{dmax}	 [bar]	(mm)	a (mm)	d (mm)	H (mm)	(kg/pc.)	Thread	Tightening torque (Nm)	EPDM	NBR
326.0	FLEX 3 326.0	322.0 - 329.0	16.5	65	211	365	405	11.9	M 16 SW 14	30	0571 8330 ...	0571 8630 ...
355.6	FLEX 3 355.6	352.0 - 259.0	15.5	65	211	395	435	12.4	M 16 SW 14	35	0571 8330 ...	0571 8630 ...
406.4	FLEX 3 406.4	402.0 - 410.0	13.5	65	211	445	485	13.4	M 16 SW 14	35	0571 8330 ...	0571 8630 ...
429.0	FLEX 3 429.0	426.0 - 431.0	12.5	65	211	465	505	13.9	M 16 SW 14	35	0571 8330 ...	0571 8630 ...
442.0	FLEX 3 442.0	439.0 - 444.0	12.0	65	211	480	520	14.1	M 16 SW 14	35	0571 8330 ...	0571 8630 ...
457.2	FLEX 3 457.2	454.0 - 459.0	12.0	65	211	495	535	14.4	M 16 SW 14	35	0571 8330 ...	0571 8630 ...
508.0	FLEX 3 508.0	505.0 - 510.0	10.5	65	211	545	585	15.4	M 16 SW 14	35	0571 8330 ...	0571 8630 ...
531.0	FLEX 3 531.0	528.0 - 534.0	10.0	65	211	570	610	15.9	M 16 SW 14	35	0571 8330 ...	0571 8630 ...
558.8	FLEX 3 558.8	556.0 - 562.0	9.5	65	211	595	635	16.4	M 16 SW 14	35	0571 8330 ...	0571 8630 ...
609.6	FLEX 3 609.6	606.0 - 613.0	9.0	65	211	645	685	17.4	M 16 SW 14	40	0571 8330 ...	0571 8630 ...
634.0	FLEX 3 634.0	631.0 - 637.0	8.5	65	211	670	710	17.9	M 16 SW 14	40	0571 8330 ...	0571 8630 ...
711.2	FLEX 3 711.2	707.0 - 715.0	7.5	65	211	750	790	19.4	M 16 SW 14	40	0571 8330 ...	0571 8630 ...
762.0	FLEX 3 762.0	758.0 - 766.0	7.0	65	211	800	840	20.4	M 16 SW 14	40	0571 8330 ...	0571 8630 ...
812.8	FLEX 3 812.8	808.0 - 817.0	6.5	65	211	850	890	21.4	M 16 SW 14	45	0571 8338 ...	0571 8638 ...
914.4	FLEX 3 914.4	909.0 - 919.0	6.0	65	211	950	990	23.4	M 16 SW 14	45	0571 8338 ...	0571 8638 ...
1016.0	FLEX 3 1016.0	1013.0 - 1019.0	5.0	65	211	1055	1095	25.4	M 16 SW 14	50	0571 8338 ...	0571 8638 ...
1117.5	FLEX 3 1117.5	114.0 - 1120.0	4.5	65	211	1155	1195	27.4	M 16 SW 14	50	0571 8338 ...	0571 8638 ...
1219.2	FLEX 3 1219.2	1216.0 - 1222.0	4.0	65	211	1255	1295	29.4	M 16 SW 14	55	0571 8338 ...	0571 8638 ...
1320.8	FLEX 3 1320.8	1314.0 - 1328.0	3.0	65	211	1360	1400	31.4	M 16 SW 14	55	0571 8338 ...	0571 8638 ...
1422.4	FLEX 3 1422.4	1415.0 - 1430.0	3.0	65	211	1460	1500	33.4	M 16 SW 14	60	0571 8338 ...	0571 8638 ...
1524.0	FLEX 3 1524.0	1516.0 - 1532.0	2.5	65	211	1560	1600	35.4	M 16 SW 14	60	0571 8338 ...	0571 8638 ...
1625.6	FLEX 3 1625.6	1617.0 - 1634.0	2.5	65	211	1665	1705	37.4	M 16 SW 14	70	0571 8338 ...	0571 8638 ...
1727.2	FLEX 3 1727.2	1718.0 - 1736.0	2.0	65	211	1765	1805	39.4	M 16 SW 14	70	0571 8338 ...	0571 8638 ...
1828.8	FLEX 3 1828.8	1819.0 - 1838.0	2.0	65	211	1865	1905	41.4	M 16 SW 14	80	0571 8338 ...	0571 8638 ...
1930.4	FLEX 3 1930.4	1320.0 - 1940.0	2.0	65	211	1970	2010	43.4	M 16 SW 14	80	0571 8338 ...	0571 8638 ...
2032.0	FLEX 3 2032.0	2021.0 - 2042.0	1.5	65	211	2070	2110	45.4	M 16 SW 14	80	0571 8338 ...	0571 8638 ...

Coupling sizes >800 mm are in 2-parts design!

... = Ø without decimals in mm

WP¹ is the max. working pressure in industrial applications, with a safety factor as per NORMA specification.

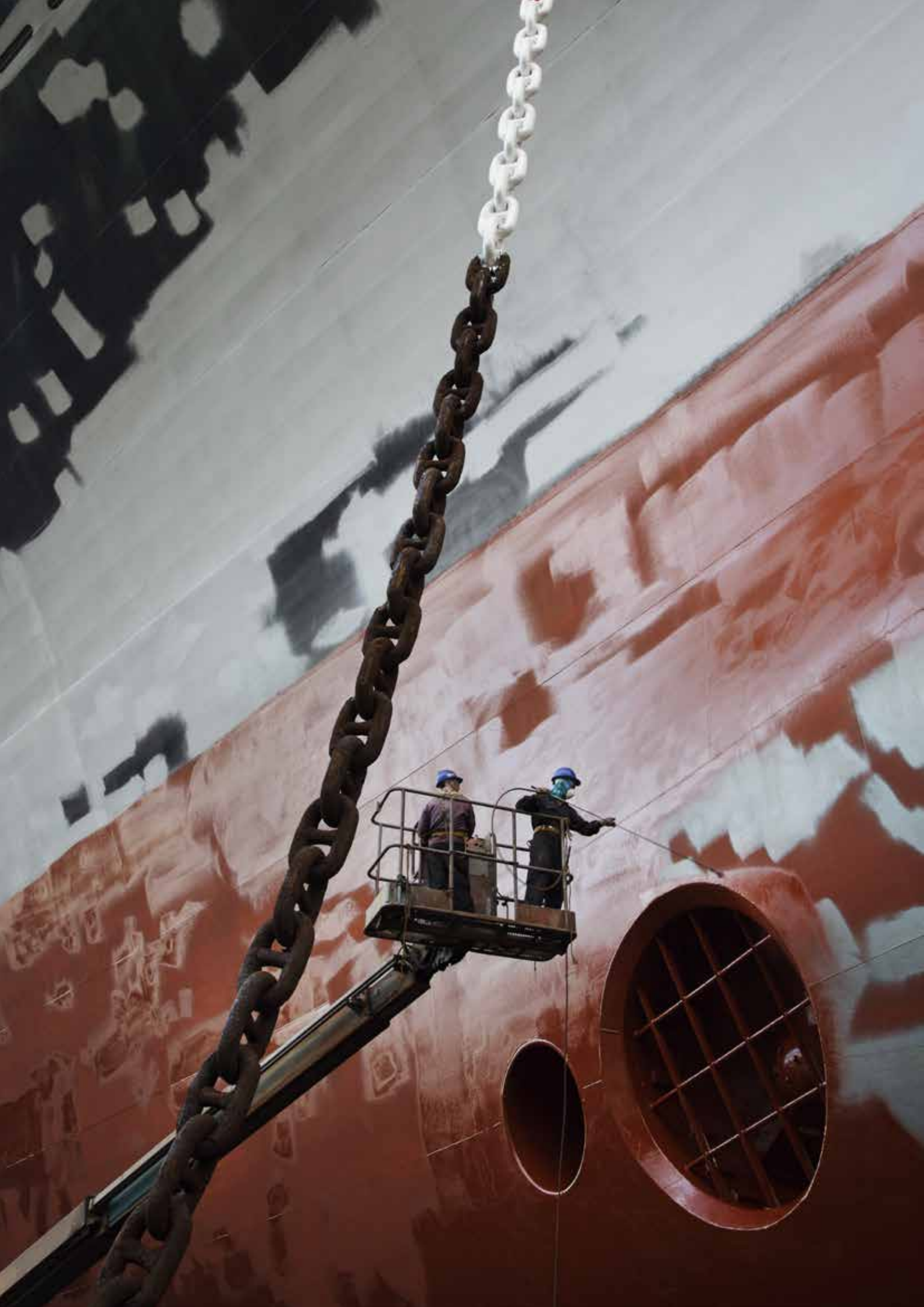



- 1 Double-lip sealing system
- 2 Standard strip insert
- 3 Lock bars
- 4 Anchoring ring with conically stamped teeth

NEW!
Now also available with FKM sealing sleeve

NORMACONNECT®

NEW

The strong pipe coupling

NORMACONNECT® GRIP/GRIP E axial restraint pipe couplings are used to connect metal pipes. The anchoring ring with conically stamped teeth indents into the pipe surface (steel, stainless steel or cast iron) and provides safe and strong axial restraint.

Owing to the special design, the coupling can withstand even high vibration loads.

Advantages at a glance

- Progressive locking effect ensures a trouble- and maintenance-free connection
- Reusable
- Shock resistant
- Space saving connector
- Withstand high vibration loads

Information

- Sizes: 26.9 mm - 812.8 mm
- Working pressure: 70.0 bar - 1 bar
- Material: AISI 304, AISI 316 Ti
- EPDM:
 Sizes from 26.9 mm up to 168.3 mm: - 30 °C up to + 125 °C
 Sizes > 180.0 mm: from - 20 °C up to + 80 °C
- NBR: from - 20 °C up to + 80 °C
- FKM: -10 °C to + 150 °C (Higher temperatures possible in some cases.)

Materials

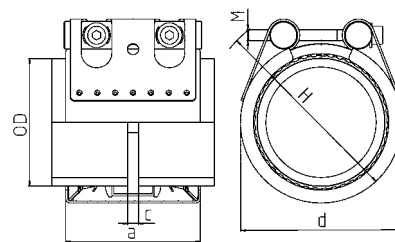

W1	W2	W3	W4	W5
	x		x	x

Technical data & Ordering information



Technical data & Ordering information

NORMACONNECT® FGR GRIP

Ø (O.D.)	Designation	Clamping ranges	PN ¹	WP ²	C max	Dimensions (approx.)			Weight (approx.)	Hex socket locking bolts	
		O _{dmin} - O _{dmax}	 [bar]	 [bar]	(mm)	a (mm)	d (mm)	H (mm)	(kg/pc.)	Thread	Tightening torque (Nm)
26.9	GRIP 26.9	26.4 - 27.5	16	70	3	67	50	70	0.39	M 8 SW 6	10
28.0	GRIP 28.0	27.5 - 28.5	16	70	3	67	50	70	0.39	M 8 SW 6	10
30.0	GRIP 30.0	29.5 - 30.6	16	70	3	67	50	70	0.39	M 8 SW 6	10
33.7	GRIP 33.7	33.0 - 34.3	16	60	3	67	55	75	0.40	M 8 SW 6	10
35.0	GRIP 35.0	34.5 - 35.6	16	60	8	63	55	75	0.55	M 8 SW 6	15
38.0	GRIP 38.0	37.5 - 38.6	16	60	8	63	60	80	0.55	M 8 SW 6	15
42.4	GRIP 42.4	41.7 - 43.0	16	50	8	63	65	85	0.56	M 8 SW 6	15
44.5	GRIP 44.5	44.0 - 45.1	16	50	8	63	65	85	0.57	M 8 SW 6	15
48.3	GRIP 48.3	47.6 - 50.5	16	50	8	63	70	90	0.59	M 8 SW 6	15
54.0	GRIP 54.0	53.3 - 54.6	16	50	17	78	75	95	0.77	M 8 SW 6	15
57.0	GRIP 57.0	56.3 - 57.7	16	50	17	78	80	100	0.77	M 8 SW 6	20
60.3	GRIP 60.3	59.5 - 61.0	16	40	17	78	85	105	0.78	M 8 SW 6	20
63.0	GRIP 63.0	62.2 - 63.9	16	40	17	78	85	105	0.78	M 8 SW 6	20
70.0	GRIP 70.0	69.0 - 71.0	16	40	25	98	90	110	1.38	M 10 SW 8	30
73.0	GRIP 73.0	72.1 - 73.8	16	40	25	98	95	115	1.40	M 10 SW 8	30
76.1	GRIP 76.1	75.2 - 77.0	16	35	25	98	100	120	1.40	M 10 SW 8	30
80.0	GRIP 80.0	79.0 - 80.8	16	35	25	98	100	120	1.44	M 10 SW 8	30
84.0	GRIP 84.0	83.0 - 85.0	16	35	25	98	105	125	1.46	M 10 SW 8	30
88.9	GRIP 88.9	87.0 - 89.9	16	35	25	98	110	130	1.48	M 10 SW 8	30
101.6	GRIP 101.6	100.4 - 102.8	16	35	25	98	125	145	1.62	M 10 SW 8	30
104.0	GRIP 104.0	102.8 - 106.1	16	35	25	98	125	145	1.63	M 10 SW 8	30
108.0	GRIP 108.0	106.8 - 109.2	16	35	25	98	130	150	1.66	M 10 SW 8	30
110.0	GRIP 110.0	108.8 - 111.4	16	35	25	98	130	150	1.71	M 10 SW 8	30
114.3	GRIP 114.3	113.0 - 115.5	16	35	25	98	135	155	1.71	M 10 SW 8	50
129.0	GRIP 129.0	127.6 - 131.1	16	32	35	115	155	185	3.06	M 12 SW 10	50
133.0	GRIP 133.0	131.5 - 134.4	16	32	35	115	160	190	3.16	M 12 SW 10	50
139.7	GRIP 139.7	138.1 - 141.6	16	32	35	115	165	195	3.27	M 12 SW 10	50
141.3	GRIP 141.3	139.6 - 142.8	16	32	35	115	170	200	3.27	M 12 SW 10	50
154.0	GRIP 154.0	152.3 - 156.1	16	32	35	115	180	210	3.39	M 12 SW 10	60
159.0	GRIP 159.0	157.3 - 160.7	16	32	35	115	185	215	3.51	M 12 SW 10	60
168.3	GRIP 168.3	166.5 - 170.1	16	32	35	115	195	225	3.57	M 12 SW 10	60
193.7	GRIP 193.7	192.0 - 196.0	16	32	35	142	225	255	6.8	M 16 SW 14	150
206.0	GRIP 206.0	202.0 - 208.0	16	32	35	142	240	270	7.0	M 16 SW 14	150
219.1	GRIP 219.1	216.0 - 221.0	16	32	35	142	250	280	7.3	M 16 SW 14	150
225.0	GRIP 225.0	222.0 - 227.0	13	26.5	35	142	255	285	7.4	M 16 SW 14	180
229.9	GRIP 229.9	228.0 - 232.0	13	26	35	142	260	290	7.5	M 16 SW 14	180
244.5	GRIP 244.5	242.0 - 247.0	12	24.5	35	142	275	305	7.7	M 16 SW 14	180
254.0	GRIP 254.0	250.0 - 256.0	11.5	22.5	35	142	285	315	7.9	M 16 SW 14	180
267.0	GRIP 267.0	264.0 - 269.0	11	22.5	35	142	300	330	8.2	M 16 SW 14	180
273.0	GRIP 273.0	270.0 - 275.0	11	22	35	142	305	335	8.3	M 16 SW 14	180
306.0	GRIP 306.0	302.0 - 308.0	9.5	19.5	35	142	340	370	8.9	M 16 SW 14	180
323.9	GRIP 323.9	320.0 - 327.0	6.5	13	35	142	355	385	9.2	M 16 SW 14	180
326.0	GRIP 326.0	322.0 - 329.0	6.5	13	35	142	360	390	9.3	M 16 SW 14	180
355.6	GRIP 355.6	352.0 - 359.0	6	12	35	142	390	420	9.8	M 16 SW 14	180
406.4	GRIP 406.4	402.0 - 410.0	4.5	9	35	142	440	470	10.8	M 16 SW 14	180
429.0	GRIP 429.0	426.0 - 431.0	4	8.5	35	142	460	490	11.3	M 16 SW 14	180
442.0	GRIP 442.0	439.0 - 444.0	4	8	35	142	475	505	11.5	M 16 SW 14	180
457.2	GRIP 457.2	454.0 - 459.0	4	8	35	142	490	520	11.8	M 16 SW 14	180
508.0	GRIP 508.0	505.0 - 510.0	2.5	5	35	142	540	570	12.7	M 16 SW 14	180
531.0	GRIP 531.0	528.0 - 534.0	2.5	5	35	142	565	595	13.2	M 16 SW 14	180
558.8	GRIP 558.8	556.0 - 562.0	2	4.5	35	142	590	620	13.7	M 16 SW 14	180
609.6	GRIP 609.6	606.0 - 613.0	1.5	3	35	142	640	670	14.7	M 16 SW 14	180
634.0	GRIP 634.0	631.0 - 637.0	1.5	3	35	142	665	695	15.1	M 16 SW 14	200
711.2	GRIP 711.2	707.0 - 715.0	1.5	2.5	35	142	745	775	16.6	M 16 Sw 14	200

PN¹ (Nominal Pressure) is the max. admissible working pressure in shipbuilding, based on a safety factor of ≥ 4 .
WP² is the max. working pressure in industrial applications, with a safety factor as per NORMA specification.

Technical data & Ordering information

NORMACONNECT® FGR GRIP								
Ø (O.D.)	Designation	W2 Product No.		W4 Product No.		W5 Product No.		
		EPDM	NBR	EPDM	NBR	EPDM	NBR	FKM
26.9	GRIP 26.9	0578 9100 026	0578 8400 026	0578 9200 026	0578 8500 026	0578 9300 026	0578 8600 026	
28.0	GRIP 28.0	0578 9100 028	0578 8400 028	0578 9200 028	0578 8500 028	0578 9300 028	0578 8600 028	
30.0	GRIP 30.0	0578 9100 030	0578 8400 030	0578 9200 030	0578 8500 030	0578 9300 030	0578 8600 030	
33.7	GRIP 33.7	0578 9100 033	0578 8400 033	0578 9200 033	0578 8500 033	0578 9300 033	0578 8600 033	0578 9900 033
35.0	GRIP 35.0	0578 9100 035	0578 8400 035	0578 9200 035	0578 8500 035	0578 9300 035	0578 8600 035	
38.0	GRIP 38.0	0578 9100 038	0578 8400 038	0578 9200 038	0578 8500 038	0578 9300 038	0578 8600 038	0578 9900 038
42.4	GRIP 42.4	0578 9100 042	0578 8400 042	0578 9200 042	0578 8500 042	0578 9300 042	0578 8600 042	0578 9900 042
44.5	GRIP 44.5	0578 9100 044	0578 8400 044	0578 9200 044	0578 8500 044	0578 9300 044	0578 8600 044	
48.3	GRIP 48.3	0578 9100 048	0578 8400 048	0578 9200 048	0578 8500 048	0578 9300 048	0578 8600 048	0578 9900 048
54.0	GRIP 54.0	0578 9100 054	0578 8400 054	0578 9200 054	0578 8500 054	0578 9300 054	0578 8600 054	
57.0	GRIP 57.0	0578 9100 057	0578 8400 057	0578 9200 057	0578 8500 057	0578 9300 057	0578 8600 057	0578 9900 057
60.3	GRIP 60.3	0578 9100 060	0578 8400 060	0578 9200 060	0578 8500 060	0578 9300 060	0578 8600 060	0578 9900 060
63.0	GRIP 63.0	0578 9100 063	0578 8400 063	0578 9200 063	0578 8500 063	0578 9300 063	0578 8600 063	0578 9900 063
70.0	GRIP 70.0	0578 9100 070	0578 8400 070	0578 9200 070	0578 8500 070	0578 9300 070	0578 8600 070	
73.0	GRIP 73.0	0578 9100 073	0578 8400 073	0578 9200 073	0578 8500 073	0578 9300 073	0578 8600 073	
76.1	GRIP 76.1	0578 9100 076	0578 8400 076	0578 9200 076	0578 8500 076	0578 9300 076	0578 8600 076	0578 9900 076
80.0	GRIP 80.0	0578 9100 080	0578 8400 080	0578 9200 080	0578 8500 080	0578 9300 080	0578 8600 080	
84.0	GRIP 84.0	0578 9100 084	0578 8400 084	0578 9200 084	0578 8500 084	0578 9300 084	0578 8600 084	
88.9	GRIP 88.9	0578 9100 088	0578 8400 088	0578 9200 088	0578 8500 088	0578 9300 088	0578 8600 088	0578 9900 088
101.6	GRIP 101.6	0578 9100 101	0578 8400 101	0578 9200 101	0578 8500 101	0578 9300 101	0578 8600 101	
104.0	GRIP 104.0	0578 9100 104	0578 8400 104	0578 9200 104	0578 8500 104	0578 9300 104	0578 8600 104	
108.0	GRIP 108.0	0578 9100 108	0578 8400 108	0578 9200 108	0578 8500 108	0578 9300 108	0578 8600 108	
110.0	GRIP 110.0	0578 9100 110	0578 8400 110	0578 9200 110	0578 8500 110	0578 9300 110	0578 8600 110	
114.3	GRIP 114.3	0578 9100 114	0578 8400 114	0578 9200 114	0578 8500 114	0578 9300 114	0578 8600 114	0578 9900 114
129.0	GRIP 129.0	0578 9100 129	0578 8400 129	0578 9200 129	0578 8500 129	0578 9300 129	0578 8600 129	0578 9900 129
133.0	GRIP 133.0	0578 9100 133	0578 8400 133	0578 9200 133	0578 8500 133	0578 9300 133	0578 8600 133	
139.7	GRIP 139.7	0578 9100 139	0578 8400 139	0578 9200 139	0578 8500 139	0578 9300 139	0578 8600 139	0578 9900 139
141.3	GRIP 141.3	0578 9100 141	0578 8400 141	0578 9200 141	0578 8500 141	0578 9300 141	0578 8600 141	
154.0	GRIP 154.0	0578 9100 154	0578 8400 154	0578 9200 154	0578 8500 154	0578 9300 154	0578 8600 154	
159.0	GRIP 159.0	0578 9100 159	0578 8400 159	0578 9200 159	0578 8500 159	0578 9300 159	0578 8600 159	
168.3	GRIP 168.3	0578 9100 168	0578 8400 168	0578 9200 168	0578 8500 168	0578 9300 168	0578 8600 168	0578 9900 168
193.7	GRIP 193.7	0577 8100 ...	0577 8400 ...	0577 8200 ...	0577 8500 ...	0577 8300 ...	0577 8600 ...	
206.0	GRIP 206.0	0577 8100 ...	0577 8400 ...	0577 8200 ...	0577 8500 ...	0577 8300 ...	0577 8600 ...	
219.1	GRIP 219.1	0577 8100 ...	0577 8400 ...	0577 8200 ...	0577 8500 ...	0577 8300 ...	0577 3600 ...	
225.0	GRIP 225.0	0577 8100 ...	0577 8400 ...	0577 8200 ...	0577 8500 ...	0577 8300 ...	0577 8600 ...	
229.9	GRIP 229.9	0577 8100 ...	0577 8400 ...	0577 8200 ...	0577 8500 ...	0577 8300 ...	0577 8600 ...	
244.5	GRIP 244.5	0577 8100 ...	0577 8400 ...	0577 8200 ...	0577 8500 ...	0577 8300 ...	0577 8600 ...	
254.0	GRIP 254.0	0577 8100 ...	0577 8400 ...	0577 8200 ...	0577 8500 ...	0577 8300 ...	0577 8600 ...	
267.0	GRIP 267.0	0577 8100 ...	0577 8400 ...	0577 8200 ...	0577 8500 ...	0577 8300 ...	0577 8600 ...	
273.0	GRIP 273.0	0577 8100 ...	0577 8400 ...	0577 8200 ...	0577 8500 ...	0577 8300 ...	0577 3600 ...	
306.0	GRIP 306.0	0577 8100 ...	0577 8400 ...	0577 8200 ...	0577 8500 ...	0577 8300 ...	0577 8600 ...	
323.9	GRIP 323.9	0577 8100 ...	0577 8400 ...	0577 8200 ...	0577 8500 ...	0577 8300 ...	0577 8600 ...	
326.0	GRIP 326.0	0577 8100 ...	0577 8400 ...	0577 8200 ...	0577 8500 ...	0577 8300 ...	0577 8600 ...	
355.6	GRIP 355.6	0577 8100 ...	0577 8400 ...	0577 8200 ...	0577 8500 ...	0577 8300 ...	0577 8600 ...	
406.4	GRIP 406.4	0577 8100 ...	0577 8400 ...	0577 8200 ...	0577 8500 ...	0577 8300 ...	0577 8600 ...	
429.0	GRIP 429.0	0577 8100 ...	0577 8400 ...	0577 8200 ...	0577 8500 ...	0577 8300 ...	0577 8600 ...	
442.0	GRIP 442.0	0577 8100 ...	0577 8400 ...	0577 8200 ...	0577 8500 ...	0577 8300 ...	0577 8600 ...	
457.2	GRIP 457.2	0577 8100 ...	0577 8400 ...	0577 8200 ...	0577 8500 ...	0577 8300 ...	0577 8600 ...	
508.0	GRIP 508.0	0577 8100 ...	0577 8400 ...	0577 8200 ...	0577 8500 ...	0577 8300 ...	0577 8600 ...	
531.0	GRIP 531.0	0577 8100 ...	0577 8400 ...	0577 8200 ...	0577 8500 ...	0577 8300 ...	0577 8600 ...	
558.8	GRIP 558.8	0577 8100 ...	0577 8400 ...	0577 8200 ...	0577 8500 ...	0577 8300 ...	0577 8600 ...	
609.6	GRIP 609.6	0577 8100 ...	0577 8400 ...	0577 8200 ...	0577 8500 ...	0577 8300 ...	0577 8600 ...	
634.0	GRIP 634.0	0577 8100 ...	0577 8400 ...	0577 8200 ...	0577 8500 ...	0577 8300 ...	0577 8600 ...	
711.2	GRIP 711.2	0577 8100 ...	0577 8400 ...	0577 8200 ...	0577 8500 ...	0577 8300 ...	0577 8600 ...	

... = Ø without decimals in mm

GRIP E

NORMACONNECT® GRIP E axial restraint pipe couplings are used to connect metal pipes.

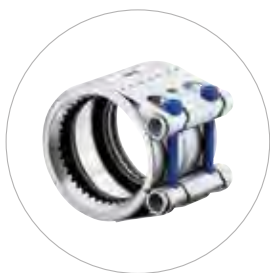

Material
W2, W5

NORMACONNECT® FGR GRIP E

Ø (O.D.)	Designation	Clamping ranges	PN ¹	WP ²	C max	Dimensions (approx.)			Weight (approx.)	Hex socket locking bolts	
		O _{min} - O _{max}	[bar]	[bar]	(mm)	a (mm)	d (mm)	H (mm)	(kg/pc.)	Thread	Tightening torque (Nm)
26.9	GRIP E 26.9	26.4 - 27.5	16	70	3	67	50	70	0.32	M 8 SW 6	10
28.0	GRIP E 28.0	27.5 - 28.5	16	70	3	67	50	70	0.32	M 8 SW 6	10
30.0	GRIP E 30.0	29.5 - 30.6	16	70	3	67	50	70	0.32	M 8 SW 6	10
33.7	GRIP E 33.7	33.0 - 34.3	16	60	3	67	55	75	0.33	M 8 SW 6	10
35.0	GRIP E 35.0	34.5 - 35.6	16	60	8	63	55	75	0.45	M 8 SW 6	15
38.0	GRIP E 38.0	37.5 - 38.6	16	60	8	63	60	80	0.45	M 8 SW 6	15
42.4	GRIP E 42.4	41.7 - 43.0	16	50	8	63	65	85	0.46	M 8 SW 6	15
44.5	GRIP E 44.5	44.0 - 45.1	16	50	8	63	65	85	0.47	M 8 SW 6	15
48.3	GRIP E 48.3	47.6 - 50.5	16	50	8	63	70	90	0.48	M 8 SW 6	15
54.0	GRIP E 54.0	53.3 - 54.6	16	50	17	78	75	95	0.62	M 8 SW 6	15
57.0	GRIP E 57.0	56.3 - 57.7	16	50	17	78	80	100	0.63	M 8 SW 6	20
60.3	GRIP E 60.3	59.5 - 61.0	16	40	17	78	85	105	0.64	M 8 SW 6	20
70.0	GRIP E 70.0	69.0 - 71.0	16	40	25	98	90	110	1.21	M 10 SW 8	30
73.0	GRIP E 73.0	72.1 - 73.8	16	40	25	98	95	115	1.23	M 10 SW 8	30
76.1	GRIP E 76.1	75.2 - 77.0	16	35	25	98	100	120	1.23	M 10 SW 8	30
80.0	GRIP E 80.0	79.0 - 80.8	16	35	25	98	100	120	1.27	M 10 SW 8	30
84.0	GRIP E 84.0	83.0 - 85.0	16	35	25	98	105	125	1.29	M 10 SW 8	30
88.9	GRIP E 88.9	87.0 - 89.9	16	35	25	98	110	130	1.31	M 10 SW 8	30
101.6	GRIP E 101.6	100.4 - 102.8	16	35	25	98	125	145	1.45	M 10 SW 8	30
104.0	GRIP E 104.0	102.8 - 106.1	16	35	25	98	125	145	1.46	M 10 SW 8	30
108.0	GRIP E 108.0	106.8 - 109.2	16	35	25	98	130	150	1.49	M 10 SW 8	30
110.0	GRIP E 110.0	108.8 - 111.4	16	35	25	98	130	150	1.54	M 10 SW 8	30
114.3	GRIP E 114.3	113.0 - 115.5	16	35	25	98	135	155	1.54	M 10 SW 8	50
129.0	GRIP E 129.0	127.6 - 131.1	16	32	35	115	155	185	2.83	M 12 SW 10	50
133.0	GRIP E 133.0	131.5 - 134.4	16	32	35	115	160	190	2.93	M 12 SW 10	50
139.7	GRIP E 139.7	138.1 - 141.6	16	32	35	115	165	195	3.04	M 12 SW 10	50
141.3	GRIP E 141.3	139.6 - 142.8	16	32	35	115	170	200	3.04	M 12 SW 10	50
154.0	GRIP E 154.0	152.3 - 156.1	16	32	35	115	180	210	3.17	M 12 SW 10	60
159.0	GRIP E 159.0	157.3 - 160.7	16	32	35	115	185	215	3.28	M 12 SW 10	60
168.3	GRIP E 168.3	166.5 - 170.1	16	32	35	115	195	225	3.35	M 12 SW 10	60
193.7	GRIP E 193.7	192.0 - 196.0	10	20	35	141	225	255	6.2	M 16 SW 14	100
206.0	GRIP E 206.0	202.0 - 208.0	10	20	35	141	240	270	6.5	M 16 SW 14	100
219.1	GRIP E 219.1	216.0 - 221.0	10	20	35	141	250	280	6.7	M 16 SW 14	100
225.0	GRIP E 225.0	222.0 - 227.0	10	16	35	140	255	285	6.2	M 16 SW 14	100
229.9	GRIP E 229.9	228.0 - 232.0	5.5	16	35	140	260	290	6.3	M 16 SW 14	100
244.5	GRIP E 244.5	242.0 - 247.0	5.5	15	35	140	275	305	6.5	M 16 SW 14	100
254.0	GRIP E 254.0	250.0 - 256.0	5.5	14	35	140	285	315	6.6	M 16 SW 14	100
267.0	GRIP E 267.0	264.0 - 269.0	5.5	13.5	35	140	300	330	6.8	M 16 SW 14	100
273.0	GRIP E 273.0	270.0 - 275.0	5.5	13	35	140	305	335	6.9	M 16 SW 14	100
306.0	GRIP E 306.0	302.0 - 308.0	5.5	10.5	35	140	340	370	7.4	M 16 SW 14	120
323.9	GRIP E 323.9	320.0 - 327.0	3	9.5	35	140	355	385	7.7	M 16 SW 14	120
326.0	GRIP E 326.0	322.0 - 329.0	3	9.5	35	140	360	390	7.7	M 16 SW 14	120
355.6	GRIP E 355.6	352.0 - 359.0	2.7	8.5	35	140	390	420	8.2	M 16 SW 14	120
406.4	GRIP E 406.4	402.0 - 410.0	2.5	7.0	35	140	440	470	8.9	M 16 SW 14	120
429.0	GRIP E 429.0	426.0 - 431.0	2.5	6.5	35	140	460	490	9.3	M 16 SW 14	120
442.0	GRIP E 442.0	439.0 - 444.0	2.5	6.5	35	140	475	505	9.5	M 16 SW 14	140
457.2	GRIP E 457.2	454.0 - 459.0	2.5	6.0	35	140	490	520	9.7	M 16 SW 14	140
508.0	GRIP E 508.0	505.0 - 510.0	2	4.0	35	140	540	570	10.5	M 16 SW 14	140
531.0	GRIP E 531.0	528.0 - 534.0	1.5	4.0	35	140	565	595	10.8	M 16 SW 14	140
558.8	GRIP E 558.8	556.0 - 562.0	1.5	3.5	35	140	590	620	11.3	M 16 SW 14	140
609.6	GRIP E 609.6	606.0 - 613.0	1	2.0	35	140	640	670	12.0	M 16 SW 14	140

PN¹ (Nominal Pressure) is the max. admissible working pressure in shipbuilding, based on a safety factor of ≥ 4.
WP² is the max. working pressure in industrial applications, with a safety factor as per NORMA specification.

Technical data & Ordering information

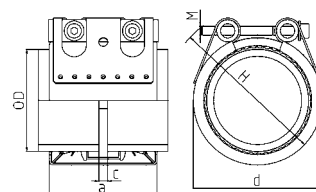

NORMACONNECT® FGR GRIP E							
Ø (O.D.)	Designation	W2 Product No.		W4 Product No.		W5 Product No.	
		EPDM	NBR	EPDM	NBR	EPDM	NBR
26.9	GRIP E 26.9	0579 9100 026	0579 8400 026	0579 9200 026	0579 8500 026	0579 9300 026	0579 8600 026
28.0	GRIP E 28.0	0579 9100 028	0579 8400 028	0579 9200 028	0579 8500 028	0579 9300 028	0579 8600 028
30.0	GRIP E 30.0	0579 9100 030	0579 8400 030	0579 9200 030	0579 8500 030	0579 9300 030	0579 8600 030
33.7	GRIP E 33.7	0579 9100 033	0579 8400 033	0579 9200 033	0579 8500 033	0579 9300 033	0579 8600 033
35.0	GRIP E 35.0	0579 9100 035	0579 8400 035	0579 9200 035	0579 8500 035	0579 9300 035	0579 8600 035
38.0	GRIP E 38.0	0579 9100 038	0579 8400 038	0579 9200 038	0579 8500 038	0579 9300 038	0579 8600 038
42.4	GRIP E 42.4	0579 9100 042	0579 8400 042	0579 9200 042	0579 8500 042	0579 9300 042	0579 8600 042
44.5	GRIP E 44.5	0579 9100 044	0579 8400 044	0579 9200 044	0579 8500 044	0579 9300 044	0579 8600 044
48.3	GRIP E 48.3	0579 9100 048	0579 8400 048	0579 9200 048	0579 8500 048	0579 9300 048	0579 8600 048
54.0	GRIP E 54.0	0579 9100 054	0579 8400 054	0579 9200 054	0579 8500 054	0579 9300 054	0579 8600 054
57.0	GRIP E 57.0	0579 9100 057	0579 8400 057	0579 9200 057	0579 8500 057	0579 9300 057	0579 8600 057
60.3	GRIP E 60.3	0579 9100 060	0579 8400 060	0579 9200 060	0579 8500 060	0579 9300 060	0579 8600 060
70.0	GRIP E 70.0	0579 9100 070	0579 8400 070	0579 9200 070	0579 8500 070	0579 9300 070	0579 8600 070
73.0	GRIP E 73.0	0579 9100 073	0579 8400 073	0579 9200 073	0579 8500 073	0579 9300 073	0579 8600 073
76.1	GRIP E 76.1	0579 9100 076	0579 8400 076	0579 9200 076	0579 8500 076	0579 9300 076	0579 8600 076
80.0	GRIP E 80.0	0579 9100 080	0579 8400 080	0579 9200 080	0579 8500 080	0579 9300 080	0579 8600 080
84.0	GRIP E 84.0	0579 9100 084	0579 8400 084	0579 9200 084	0579 8500 084	0579 9300 084	0579 8600 084
88.9	GRIP E 88.9	0579 9100 088	0579 8400 088	0579 9200 088	0579 8500 088	0579 9300 088	0579 8600 088
101.6	GRIP E 101.6	0579 9100 101	0579 8400 101	0579 9200 101	0579 8500 101	0579 9300 101	0579 8600 101
104.0	GRIP E 104.0	0579 9100 104	0579 8400 104	0579 9200 104	0579 8500 104	0579 9300 104	0579 8600 104
108.0	GRIP E 108.0	0579 9100 108	0579 8400 108	0579 9200 108	0579 8500 108	0579 9300 108	0579 8600 108
110.0	GRIP E 110.0	0579 9100 110	0579 8400 110	0579 9200 110	0579 8500 110	0579 9300 110	0579 8600 110
114.3	GRIP E 114.3	0579 9100 114	0579 8400 114	0579 9200 114	0579 8500 114	0579 9300 114	0579 8600 114
129.0	GRIP E 129.0	0579 9100 129	0579 8400 129	0579 9200 129	0579 8500 129	0579 9300 129	0579 8600 129
133.0	GRIP E 133.0	0579 9100 133	0579 8400 133	0579 9200 133	0579 8500 133	0579 9300 133	0579 8600 133
139.7	GRIP E 139.7	0579 9100 139	0579 8400 139	0579 9200 139	0579 8500 139	0579 9300 139	0579 8600 139
141.3	GRIP E 141.3	0579 9100 141	0579 8400 141	0579 9200 141	0579 8500 141	0579 9300 141	0579 8600 141
154.0	GRIP E 154.0	0579 9100 154	0579 8400 154	0579 9200 154	0579 8500 154	0579 9300 154	0579 8600 154
159.0	GRIP E 159.0	0579 9100 159	0579 8400 159	0579 9200 159	0579 8500 159	0579 9300 159	0579 8600 159
168.3	GRIP E 168.3	0579 9100 168	0579 8400 168	0579 9200 168	0579 8500 168	0579 9300 168	0579 8600 168
193.7	GRIP E 193.7	0574 8100 ...	0574 8400 ...	0574 8200 ...	0574 8500 ...	0574 8300 ...	0574 8600 ...
206.0	GRIP E 206.0	0574 8100 ...	0574 8400 ...	0574 8200 ...	0574 8500 ...	0574 8300 ...	0574 8600 ...
219.1	GRIP E 219.1	0574 8100 ...	0574 8400 ...	0574 8200 ...	0574 8500 ...	0574 8300 ...	0574 8600 ...
225.0	GRIP E 225.0	0574 8100 ...	0574 8400 ...	0574 8200 ...	0574 8500 ...	0574 8300 ...	0574 8600 ...
229.9	GRIP E 229.9	0574 8100 ...	0574 8400 ...	0574 8200 ...	0574 8500 ...	0574 8300 ...	0574 8600 ...
244.5	GRIP E 244.5	0574 8100 ...	0574 8400 ...	0574 8200 ...	0574 8500 ...	0574 8300 ...	0574 8600 ...
254.0	GRIP E 254.0	0574 8100 ...	0574 8400 ...	0574 8200 ...	0574 8500 ...	0574 8300 ...	0574 8600 ...
267.0	GRIP E 267.0	0574 8100 ...	0574 8400 ...	0574 8200 ...	0574 8500 ...	0574 8300 ...	0574 8600 ...
273.0	GRIP E 273.0	0574 8100 ...	0574 8400 ...	0574 8200 ...	0574 8500 ...	0574 8300 ...	0574 8600 ...
306.0	GRIP E 306.0	0574 8100 ...	0574 8400 ...	0574 8200 ...	0574 8500 ...	0574 8300 ...	0574 8600 ...
323.9	GRIP E 323.9	0574 8100 ...	0574 8400 ...	0574 8200 ...	0574 8500 ...	0574 8300 ...	0574 8600 ...
326.0	GRIP E 326.0	0574 8100 ...	0574 8400 ...	0574 8200 ...	0574 8500 ...	0574 8300 ...	0574 8600 ...
355.6	GRIP E 355.6	0574 8100 ...	0574 8400 ...	0574 8200 ...	0574 8500 ...	0574 8300 ...	0574 8600 ...
406.4	GRIP E 406.4	0574 8100 ...	0574 8400 ...	0574 8200 ...	0574 8500 ...	0574 8300 ...	0574 8600 ...
429.0	GRIP E 429.0	0574 8100 ...	0574 8400 ...	0574 8200 ...	0574 8500 ...	0574 8300 ...	0574 8600 ...
442.0	GRIP E 442.0	0574 8100 ...	0574 8400 ...	0574 8200 ...	0574 8500 ...	0574 8300 ...	0574 8600 ...
457.2	GRIP E 457.2	0574 8100 ...	0574 8400 ...	0574 8200 ...	0574 8500 ...	0574 8300 ...	0574 8600 ...
508.0	GRIP E 508.0	0574 8100 ...	0574 8400 ...	0574 8200 ...	0574 8500 ...	0574 8300 ...	0574 8600 ...
531.0	GRIP E 531.0	0574 8100 ...	0574 8400 ...	0574 8200 ...	0574 8500 ...	0574 8300 ...	0574 8600 ...
558.8	GRIP E 558.8	0574 8100 ...	0574 8400 ...	0574 8200 ...	0574 8500 ...	0574 8300 ...	0574 8600 ...
609.6	GRIP E 609.6	0574 8100 ...	0574 8400 ...	0574 8200 ...	0574 8500 ...	0574 8300 ...	0574 8600 ...

... = Ø without decimals in mm



- 1 Double-lip sealing system
- 2 Standard strip insert
- 3 Conically stamped anchoring ring
- 4 Flame protection housing

The fire resistant coupling

NORMACONNECT® GRIP E-FP pipe couplings with integrated flame protection are used with applications in the marine sector (civil and military) as well as in sprinkler systems. For this purpose the GRIP E type has been equipped with an additional housing made from stainless steel plus a fire-resistant lining which can resist temperatures of 850 °C and upwards.

Advantages at a glance

- Dampens absorbing vibrations, pressure surges
- Weight saving
- Tension free
- Ready to install

Information

- Sizes: 40.0 mm - 406.0 mm
- Working pressure: 16.0 - 6.0 bar
- Material: AISI 304, AISI 316 Ti
- EPDM:
 - Sizes from 26.9 mm up to 168.3 mm: - 30 °C up to + 125 °C
 - Sizes > 180.0 mm: from - 20 °C up to + 80 °C
- NBR: from - 20 °C up to + 80 °C

Materials

W1	W2	W3	W4	W5
				x

Technical data & ordering information

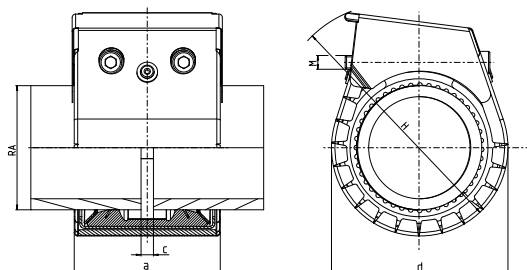

Technical data & Ordering information

NORMACONNECT® FGR GRIP E-FP

Ø (O.D.)	Designation	Clamping ranges	PN ¹ (MAWP ¹ from diameter 180)	WP ²	C max	Dimensions (approx.)			Weight (approx.)	Hex socket locking bolts		W5 Product No.	
			[bar]			[bar]	a (mm)	d (mm)		H (mm)	(kg/pc.)	Thread	Tightening torque (Nm)
26.9	GRIP E-FP 26.9	26.4 - 27.5	16	70	3	67	60	110	0.42	M 8 SW 6	10	0579 9370 026	0579 8670 026
28.0	GRIP E-FP 28.0	27.5 - 28.5	16	70	3	67	60	110	0.42	M 8 SW 6	10	0579 9370 028	0579 8670 028
30.0	GRIP E-FP 30.0	29.5 - 30.6	16	70	3	67	60	110	0.42	M 8 SW 6	10	0579 9370 030	0579 8670 030
33.7	GRIP E-FP 33.7	33.0 - 34.3	16	60	3	67	65	115	0.43	M 8 SW 6	10	0579 9370 033	0579 8670 033
35.0	GRIP E-FP 35.0	34.5 - 35.6	16	60	8	75	65	115	0.58	M 8 SW 6	15	0579 9370 035	0579 8670 035
38.0	GRIP E-FP 38.0	37.5 - 38.6	16	60	8	75	70	120	0.58	M 8 SW 6	15	0579 9370 038	0579 8670 038
42.4	GRIP E-FP 42.4	41.7 - 43.0	16	50	8	75	75	125	0.59	M 8 SW 6	15	0579 9370 042	0579 8670 042
44.5	GRIP E-FP 44.5	44.0 - 45.1	16	50	8	75	75	125	0.60	M 8 SW 6	15	0579 9370 044	0579 8670 044
48.3	GRIP E-FP 48.3	47.6 - 50.5	16	50	8	75	80	130	0.61	M 8 SW 6	15	0579 9370 048	0579 8670 048
54.0	GRIP E-FP 54.0	53.3 - 54.6	16	50	17	90	85	135	0.92	M 8 SW 6	15	0579 9370 054	0579 8670 054
57.0	GRIP E-FP 57.0	56.3 - 57.7	16	50	17	90	90	140	0.93	M 8 SW 6	20	0579 9370 057	0579 8670 057
60.3	GRIP E-FP 60.3	59.5 - 61.0	16	40	17	90	95	145	0.94	M 8 SW 6	20	0579 9370 060	0579 8670 060
73.0	GRIP E-FP 73.0	72.1 - 73.8	16	40	17	90	95	145	0.94	M 10 SW 8	30	0579 9370 073	0579 8670 073
76.1	GRIP E-FP 76.1	75.2 - 77.0	16	35	25	110	105	155	1.49	M 10 SW 8	30	0579 9370 076	0579 8670 076
84.0	GRIP E-FP 84.0	83.0 - 85.0	16	35	25	110	110	160	1.49	M 10 SW 8	30	0579 9370 084	0579 8670 084
88.9	GRIP E-FP 88.9	87.0 - 89.9	16	35	25	110	115	165	1.56	M 10 SW 8	30	0579 9370 088	0579 8670 088
101.6	GRIP E-FP 101.6	100.4 - 102.8	16	35	25	110	120	170	1.59	M 10 SW 8	30	0579 9370 101	0579 8670 101
104.0	GRIP E-FP 104.0	102.8 - 106.1	16	35	25	110	135	185	1.75	M 10 SW 8	30	0579 9370 104	0579 8670 104
108.0	GRIP E-FP 108.0	106.8 - 109.2	16	35	25	110	135	185	1.76	M 10 SW 8	30	0579 9370 108	0579 8670 108
110.0	GRIP E-FP 110.0	108.8 - 111.4	16	35	25	110	140	190	1.79	M 10 SW 8	30	0579 9370 110	0579 8670 110
114.3	GRIP E-FP 114.3	113.0 - 115.5	16	35	25	110	145	195	1.89	M 10 SW 8	40	0579 9370 114	0579 8670 114
129.0	GRIP E-FP 129.0	127.6 - 131.1	16	32	35	125	165	215	3.25	M 12 SW 10	50	0579 9370 129	0579 8670 129
133.0	GRIP E-FP 133.0	131.5 - 134.4	16	32	35	125	170	220	3.36	M 12 SW 10	50	0579 9370 133	0579 8670 133
139.7	GRIP E-FP 139.7	138.1 - 141.6	16	32	35	125	175	225	3.48	M 12 SW 10	50	0579 9370 139	0579 8670 139
141.3	GRIP E-FP 141.3	139.6 - 142.8	16	32	35	125	180	230	3.48	M 12 SW 10	50	0579 9370 141	0579 8670 141
154.0	GRIP E-FP 154.0	152.3 - 156.1	16	32	35	125	190	240	3.63	M 12 SW 10	60	0579 9370 154	0579 8670 154
159.0	GRIP E-FP 159.0	157.3 - 160.7	16	32	35	125	195	245	3.75	M 12 SW 10	60	0579 9370 159	0579 8670 159
168.3	GRIP E-FP 168.3	166.5 - 170.1	16	32	35	125	205	255	3.83	M 12 SW 10	60	0579 9370 168	0579 8670 168
193.7	GRIP E-FP 193.7	192.0 - 196.0	10	20	35	125	235	285	6.9	M 16 SW 14	100	0579 9370 193	0579 8670 193
206.0	GRIP E-FP 206.0	202.0 - 208.0	10	20	35	125	250	300	7.2	M 16 SW 14	100	0579 9370 206	0579 8670 206
219.1	GRIP E-FP 219.1	216.0 - 221.0	10	20	35	125	260	310	7.4	M 16 SW 14	100	0574 8370 219	0574 8670 219
225.0	GRIP E-FP 225.0	222.0 - 227.0	10	16	35	155	265	315	7.0	M 16 SW 14	100	0579 9370 225	0579 8670 225
229.9	GRIP E-FP 229.9	228.0 - 232.0	5.5	16	35	155	270	320	7.0	M 16 SW 14	100	0579 9370 229	0579 8670 229
244.5	GRIP E-FP 244.5	242.0 - 247.0	5.5	15	35	155	285	335	7.3	M 16 SW 14	100	0579 9370 244	0579 8670 244
254.5	GRIP E-FP 254.5	250.0 - 256.0	5.5	14	35	155	285	335	7.5	M 16 SW 14	100	0579 9370 254	0579 8670 254
267.0	GRIP E-FP 267.0	264.0 - 269.0	5.5	13.5	35	155	310	360	7.7	M 16 SW 14	100	0579 9370 267	0579 8670 267
273.0	GRIP E-FP 273.0	270.0 - 275.0	5.5	13	35	155	315	365	7.8	M 16 SW 14	100	0579 9370 273	0579 8670 273
306.0	GRIP E-FP 306.0	302.0 - 308.0	5.5	10.5	35	155	350	400	8.4	M 16 SW 14	120	0579 9370 306	0579 8670 306
323.9	GRIP E-FP 323.9	320.0 - 327.0	3	9.5	35	155	365	415	8.7	M 16 SW 14	120	0579 9370 323	0579 8670 323
326.0	GRIP E-FP 326.0	322.0 - 329.0	3	9.5	35	155	370	420	8.8	M 16 SW 14	120	0579 9370 326	0579 8670 326
355.6	GRIP E-FP 355.6	352.0 - 359.0	2.7	8.5	35	155	400	450	9.3	M 16 SW 14	120	0579 9370 355	0579 8670 355
406.4	GRIP E-FP 406.4	402.0 - 410.0	2.5	7.0	35	155	450	500	10.2	M 16 SW 14	120	0579 9370 406	0579 8670 406
419.0	GRIP E-FP 419.0	415.0 - 422.0	2.5	6.5	35	155	460	510	10.4	M 16 SW 14	180	0579 9370 419	0579 8670 419

PN¹ (Nominal Pressure) is the max. admissible working pressure in shipbuilding, based on a safety factor of ≥ 4.

MAWP¹ (Maximum Allowable Working Pressure) is the max. admissible working pressure in shipbuilding, based on a safety factor of ≥ 4.

WP² is the max. working pressure in industrial applications, with a safety factor as per NORMA specification.

... = Ø without decimals in mm



- 1 **Metal housing made from AISI 316 Ti**
- 2 **Environmentally-friendly – No use of chemicals**
- 3 **Shoulders of the coupling are flame protected**



Double-locked safeguards prevent accidental dismantling

RFP for application at shipbuilding

The NORMACONNECT® RFP is a retrofittable flame protector housing that has been specially designed for use with all NORMACONNECT® FLEX and GRIP pipe couplings. Its low weight and straightforward design allows quick, easy assembly without any tools. The built-in flame resistant mineral fiber mat provides a premium level of flame protection. The Retrofit Flame Protector (RFP) housing has been extensively tested and is approved by several international classification societies.

Advantages at a glance

- Retrofittable
- Easy assembly without tooling
- Low weight
- Meets current IACS requirements
- No chemicals in flame protection mat
- High flexibility
- Clear identification whether coupling is flame protected or not
- Mechanical stress resistant
- Less warehouse costs

Technical data & Ordering information

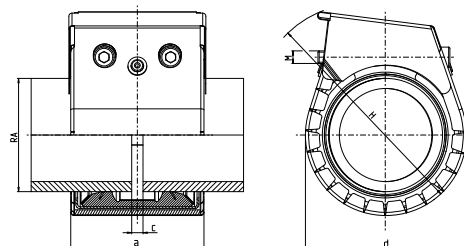

NORMACONNECT® FGR RFP						
Ø (O.D.)	Designation	Dimensions (approx.)			Weight of RFP (approx.)	W5 Product No.
		a (mm)	d (mm)	H* (mm)	(kg/piece)	
26.9	NC RFP W5 RFP 26.9	69	60	110	0.09	0573 0000 026
28.0	NC RFP W5 RFP 28.0	69	60	110	0.09	0573 0000 028
30.0	NC RFP W5 RFP 30.0	69	60	110	0.10	0573 0000 030
33.7	NC RFP W5 RFP 33.7	69	65	115	0.10	0573 0000 033
38.0	NC RFP W5 RFP 38.0	75	70	120	0.11	0573 0000 038
42.4	NC RFP W5 RFP 42.4	75	75	125	0.12	0573 0000 042
44.5	NC RFP W5 RFP 44.5	75	75	125	0.12	0573 0000 044
48.3	NC RFP W5 RFP 48.3	75	80	130	0.13	0573 0000 048
54.0	NC RFP W5 RFP 54.0	90	90	135	0.14	0573 0000 054
57.0	NC RFP W5 RFP 57.0	90	90	140	0.16	0573 0000 057
60.3	NC RFP W5 RFP 60.3	90	95	145	0.16	0573 0000 060
76.1	NC RFP W5 RFP 76.1	110	110	160	0.24	0573 0000 076
88.9	NC RFP W5 RFP 88.9	110	120	170	0.26	0573 0000 088
101.6	NC RFP W5 RFP 101.6	110	135	185	0.28	0573 0000 101
104.0	NC RFP W5 RFP 104.0	110	135	185	0.29	0573 0000 104
108.0	NC RFP W5 RFP 108.0	110	140	190	0.30	0573 0000 108
114.3	NC RFP W5 RFP 114.3	110	145	195	0.31	0573 0000 114
133.0	NC RFP W5 RFP 133.0	125	170	220	0.41	0573 0000 133
139.7	NC RFP W5 RFP 139.7	125	175	225	0.43	0573 0000 139
154.0	NC RFP W5 RFP 154.0	125	190	240	0.45	0573 0000 154
159.0	NC RFP W5 RFP 159.0	125	195	245	0.49	0573 0000 159
168.3	NC RFP W5 RFP 168.3	125	205	255	0.50	0573 0000 168
219.1	NC RFP W5 RFP 219.1	155	260	310	0.73	0573 0000 219
273.0	NC RFP W5 RFP 273.0	155	315	365	0.87	0573 0000 273

* Dimensions of the housing are given as assembled on a NORMACONNECT Grip/ Grip E/ Flex/ Flex E pipe coupling. Further sizes available on request.

Information

Sizes from 26.9 mm up to 406,4 mm

Materials

W1	W2	W3	W4	W5
				x



- 1 Double-lip sealing system
- 2 Standard strip insert
- 3 Anchoring ring

The coupling for plastic pipes

NORMACONNECT® PLAST GRIP/PLAST GRIP E axial restraint pipe couplings are used to connect plastic pipes.

The specially designed anchoring ring, featuring flat rows of teeth, engages into the pipe surface without damaging the plastic material. The force applied is distributed evenly across the pipe surface.

Advantages at a glance

- Also usable for weak plastic pipes, PP, PE
- Also available with hollow trunnions for weight-saving

Information

- Sizes: 40.0 mm - 406.0 mm
- Working pressure: 16.0 - 6.0 bar
- Material: AISI 304, AISI 316 Ti
- EPDM:
 - Sizes from 26.9 mm up to 168.3 mm - 30 °C up to + 125 °C
 - Sizes > 180.0 mm: - 20 °C up to + 80 °C
- NBR: - 20 °C up to + 80 °C

Materials

W1	W2	W3	W4	W5
				x

Technical data & ordering information

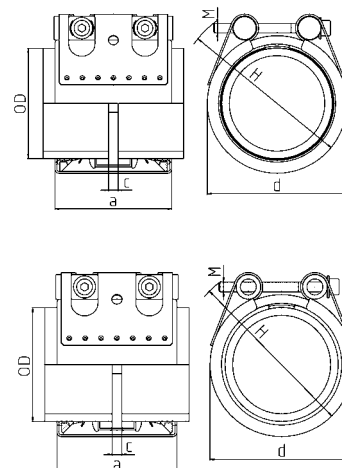

PLAST GRIP/PLAST GRIP E

NORMACONNECT® PLAST GRIP E axial restraint pipe couplings are used to connect plastic pipes.

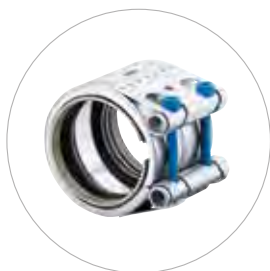

Main advantage



Weight-saving

Material



W5

Technical data & Ordering information

NORMACONNECT® FGR PLAST GRIP E

Ø (O.D.)	Designation	Clamping ranges	PN ¹	WP ²	C max	Dimensions (approx.)			Weight (approx.)	Hex socket locking bolts		W5 Product No.	
		O _{dmin} - O _{dmax}			(mm)	a (mm)	d (mm)	H (mm)	(kg/pc.)	Thread	Tightening torque (Nm)	EPDM	NBR
40.0	PLAST GRIP E W5 40	39.0 - 40.5	10	16	8	62	60	80	0.48	M 8 SW 6	15	0581 9360 040	0581 8660 040
42.4	PLAST GRIP E W5 42	41.7 - 43.0	10	16	8	62	65	85	0.48	M 8 SW 6	15	0581 9360 042	0581 8660 042
44.5	PLAST GRIP E W5 44	42.0 - 46.0	10	16	8	62	70	90	0.5	M 8 SW 6	15	0581 9360 044	0581 8660 044
48.3	PLAST GRIP E W5 48	47.6 - 49.5	10	16	8	62	70	90	0.52	M 8 SW 6	15	0581 9360 048	0581 8660 048
50.0	PLAST GRIP E W5 50	49.0 - 50.5	10	16	8	62	70	90	0.52	M 8 SW 6	15	0581 9360 050	0581 8660 050
60.3	PLAST GRIP E W5 60	59.5 - 61.0	10	16	17	78	85	105	0.67	M 8 SW 6	20	0581 9360 060	0581 8660 060
63.0	PLAST GRIP E W5 63	62.0 - 63.5	10	16	17	78	85	105	0.67	M 8 SW 6	20	0581 9360 063	0581 8660 063
75.0	PLAST GRIP E W5 75	74.0 - 76.0	10	16	25	98	100	120	1.33	M 10 SW 8	30	0581 9360 075	0581 8660 075
76.1	PLAST GRIP E W5 76	75.0 - 77.0	10	16	25	98	100	120	1.33	M 10 SW 8	30	0581 9360 076	0581 8660 076
88.9	PLAST GRIP E W5 88	88.0 - 90.0	10	16	25	98	110	130	1.42	M 10 SW 8	30	0581 9360 088	0581 8660 088
90.0	PLAST GRIP E W5 90	89.0 - 91.0	10	16	25	98	110	130	1.42	M 10 SW 8	30	0581 9360 090	0581 8660 090
101.3	PLAST GRIP E W5 101	100.4 - 102.8	10	16	25	98	125	145	1.58	M 10 SW 8	30	0581 9360 101	0581 8660 101
104.0	PLAST GRIP E W5 104	102.8 - 106.1	10	16	25	98	125	145	1.6	M 10 SW 8	30	0581 9360 104	0581 8660 104
108.0	PLAST GRIP E W5 108	108.8 - 111.4	10	16	25	98	130	150	1.62	M 10 SW 8	30	0581 9360 108	0581 8660 108
110.0	PLAST GRIP E W5 110	109.0 - 111.0	10	16	25	98	130	150	1.66	M 10 SW 8	30	0581 9360 110	0581 8660 110
114.3	PLAST GRIP E W5 114	113.0 - 115.5	10	16	25	98	135	155	1.66	M 12 SW 10	40	0581 9360 114	0581 8660 114
125.0	PLAST GRIP E W5 125	124.0 - 126.0	10	16	35	115	140	160	2.42	M 12 SW 10	40	0581 9360 125	0581 8660 125
129.0	PLAST GRIP E W5 129	127.6 - 131.1	10	16	35	115	140	160	3.06	M 12 SW 10	40	0581 9360 129	0581 8660 129
133.0	PLAST GRIP E W5 133	131.5 - 134.4	10	16	35	115	150	170	3.16	M 12 SW 10	40	0581 9360 133	0581 8660 133
140.0	PLAST GRIP E W5 140	139.0 - 141.0	10	16	35	115	160	180	3.18	M 12 SW 10	50	0581 9360 140	0581 8660 140
154.0	PLAST GRIP E W5 154	152.3 - 156.1	10	16	35	115	170	190	3.27	M 12 SW 10	50	0581 9360 154	0581 8660 154
159.0	PLAST GRIP E W5 159	157.3 - 160.7	10	16	35	115	180	200	3.39	M 12 SW 10	50	0581 9360 159	0581 8660 159
160.0	PLAST GRIP E W5 160	159.0 - 162.0	10	16	35	115	180	200	3.45	M 12 SW 10	60	0581 9360 160	0581 8660 160
168.3	PLAST GRIP E W5 168	166.5 - 170.1	10	16	35	115	190	200	3.48	M 12 SW 10	60	0581 9360 168	0581 8660 168

NORMACONNECT® FGR PLAST GRIP

Ø (O.D.)	Designation	Clamping ranges	PN ¹	WP ²	C max	Dimensions (approx.)			Weight (approx.)	Hex socket locking bolts		W5 Product No.	
		O _{dmin} - O _{dmax}			(mm)	a (mm)	d (mm)	H (mm)	(kg/pc.)	Thread	Tightening torque (Nm)	EPDM	NBR
180.0	PLAST GRIP W5 180	178.0 - 182.0	-	16	35	142	210	240	7.6	M 12 SW 10	60	0581 8350 180	0581 8650 180
200.0	PLAST GRIP W5 200	198.0 - 202.0	-	16	35	142	230	260	8.1	M 12 SW 10	60	0581 8350 200	0581 8650 200
219.1	PLAST GRIP W5 219	217.0 - 222.0	-	16	35	142	250	280	8.6	M 12 SW 10	60	0581 8350 219	0581 8650 219
225.0	PLAST GRIP W5 225	222.0 - 227.0	-	10	35	142	255	285	8.7	M 12 SW 10	60	0581 8350 225	0581 8650 225
250.0	PLAST GRIP W5 250	247.0 - 253.0	-	10	35	142	280	310	9.4	M 12 SW 10	80	0581 8350 250	0581 8650 250
273.0	PLAST GRIP W5 273	271.0 - 276.0	-	10	35	142	305	335	9.9	M 16 SW 14	100	0581 8350 273	0581 8650 273
280.0	PLAST GRIP W5 280	277.0 - 283.0	-	10	35	142	310	340	10.1	M 16 SW 14	100	0581 8350 280	0581 8650 280
315.0	PLAST GRIP W5 315	311.0 - 318.0	-	10	35	142	345	375	11	M 16 SW 14	100	0581 8350 315	0581 8650 315
323.9	PLAST GRIP W5 323	320.0 - 327.0	-	6	35	142	355	385	11.2	M 16 SW 14	100	0581 8350 323	0581 8650 323
355.0	PLAST GRIP W5 355	352.0 - 359.0	-	6	35	142	385	415	12	M 16 SW 14	120	0581 8350 355	0581 8650 355
400.0	PLAST GRIP W5 400	396.0 - 404.0	-	6	35	142	430	460	13.1	M 16 SW 14	120	0581 8350 400	0581 8650 400
406.4	PLAST GRIP W5 406.4	402.0 - 410.0	-	6	35	142	440	470	13.3	M 16 SW 14	120	0581 8350 406	0581 8650 406

PN¹ (Nominal Pressure) is the max. admissible working pressure in shipbuilding, based on a safety factor of ≥ 4.
 WP² is the max. working pressure in industrial applications, with a safety factor as per NORMA specification.

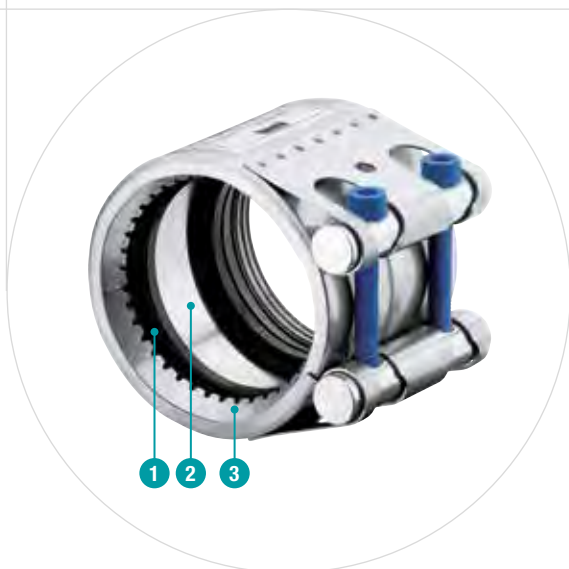

- 1 Double-lip sealing system
- 2 Standard strip insert
- 3 Anchoring ring

The combining pipe coupling

NORMACONNECT® COMBI GRIP/COMBI GRIP E axial restraint pipe couplings are used to connect plastic pipes with metal pipes.

On the side connecting the plastic pipe, the coupling has a special anchoring ring with rows of flat teeth which are pressed into the pipe surface without damaging the material. At the same time the force applied is distributed evenly across the pipe surface.

On the side connecting the metal pipe, the coupling has a different anchoring ring with conically stamped teeth which grip into the pipe surface. Due to the special design of the anchoring ring the coupling can withstand even high vibration loads. NORMACONNECT® COMBI GRIP E has hollow trunnions (smaller diameters). NORMACONNECT® COMBI GRIP has solid trunnions (larger diameters).

Advantages at a glance

- Corrosion resistant
- No welding
- No special tools necessary
- Installation and working in every kind of weather (hot and cold)
- Reusable

Information

- Sizes: from 38/40.0 mm to 406.0/406.0 mm
- Working pressure: 16.0 - 6.0 bar
- Material: AISI 304, AISI 316 Ti
- EPDM:
 - Sizes from 26.9 mm up to 168.3 mm: - 30 °C up to + 125 °C
 - Sizes > 180.0 mm: - 20 °C up to + 80 °C
- NBR: from - 20 °C up to + 80 °C

Materials

W1	W2	W3	W4	W5
				x

Technical data & Ordering information

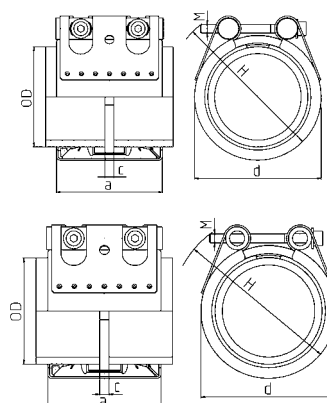

COMBI GRIP/COMBI GRIP E



NORMACONNECT® COMBI GRIP/COMBI GRIP E axial restraint pipe couplings are used to connect plastic pipes with metal pipes.

Advantages at a glance

- COMBI GRIP E has hollow trunnions (smaller diameters)
- COMBI GRIP has solid trunnions (larger diameters)

Material

W5

Technical data & Ordering information

NORMACONNECT® FGR COMBI GRIP E														
Ø (O.D.)	Designation	Clamping ranges O _{dmin} - O _{dmax} (mm)		PN ¹ [bar]	WP ² [bar]	C max (mm)	Dimensions (approx.)			Weight (approx.) (kg/pc.)	Hex socket locking bolts		W5 Product No.	
		Plastic	Metal				a (mm)	d (mm)	H (mm)		Thread	Tightening torque (Nm)	EPDM	NBR
40.0 / 38.0	COMBI GRIP E 40.0 / 38.0	39.0-40.5	37.5-38.6	10	16	8	62	60	80	0.46	M 8 SW 6	15	0584 9360 038	0584 8660 038
40.0 / 42.4	COMBI GRIP E 40.0 / 42.4	39.0-40.5	41.7-43.0	10	16	8	62	65	85	0.47	M 8 SW 6	15	0584 9360 042	0584 8660 042
42.4 / 42.4	COMBI GRIP E 42.4 / 42.4	41.7-43.0	41.7-43.0	10	16	8	62	65	85	0.47	M 8 SW 6	15	0584 9360 043	0584 8660 043
48.3 / 48.3	COMBI GRIP E 48.3 / 48.3	47.6-50.5	53.3-54.6	10	16	17	78	70	90	0.5	M 8 SW 6	15	0584 9360 046	0584 8660 046
50.0 / 48.3	COMBI GRIP E 50.0 / 48.3	47.6-51.0	47.6-50.5	10	16	8	62	70	90	0.5	M 8 SW 6	15	0584 9360 048	0584 8660 048
56.0 / 54.0*	COMBI GRIP E 56.0 / 54.0	55.0-56.5	53.3-54.6	-	5*	17	78	80	100	0.62	M 8 SW 6	15	0584 9360 054	0584 8660 054
60.3 / 60.3	COMBI GRIP E 60.3 / 60.3	59.5-61.0	59.5-61.0	10	16	17	78	85	105	0.65	M 8 SW 6	20	0584 9360 061	0584 8660 061
63.0 / 60.3	COMBI GRIP E 63.0 / 60.3	62.0-63.5	59.5-61.0	10	16	17	78	85	105	0.65	M 8 SW 6	20	0584 9360 060	0584 8660 060
73.0 / 73.0	COMBI GRIP E 73.0 / 73.0	72.0-74.0	72.1-73.8	10	16	25	98	95	115	1.3	M 10 SW 8	30	0584 9360 073	0584 8660 073
75.0 / 76.1	COMBI GRIP E 75.0 / 76.1	74.0-76.0	75.2-77.0	10	16	25	98	100	120	1.3	M 10 SW 8	30	0584 9360 076	0584 8660 076
88.9 / 88.9	COMBI GRIP E 88.9 / 90.0	88.0-90.0	87.0-89.9	10	16	25	98	110	130	1.39	M 10 SW 8	30	0584 9360 086	0584 8660 086
90.0 / 88.9	COMBI GRIP E 90.0 / 88.9	89.0-91.0	87.0-89.9	10	16	25	98	110	130	1.39	M 10 SW 8	30	0584 9360 088	0584 8660 088
101.6 / 101.6	COMBI GRIP E 101.6 / 101.6	100.4-102.8	100.4-102.8	10	16	25	98	125	145	1.54	M 10 SW 8	30	0584 9360 101	0584 8660 101
110.0 / 108.0	COMBI GRIP E 110.0 / 108.0	109.0-111.0	106.8-109.2	10	16	25	98	130	150	1.58	M 10 SW 8	40	0584 9360 108	0584 8660 108
110.0 / 114.3	COMBI GRIP E 110.0 / 114.3	109.0-111.0	113.0-115.5	10	16	25	98	135	155	1.62	M 10 SW 8	40	0584 9360 110	0584 8660 110
114.3 / 114.3	COMBI GRIP E 114.3 / 114.3	113.0-115.5	113.0-115.5	10	16	25	98	135	155	1.62	M 12 SW 10	40	0584 9360 114	0584 8660 114
140.0 / 139.7	COMBI GRIP E 140.0 / 139.7	139.0-141.0	138.1-141.6	10	16	35	115	160	180	3.14	M 12 SW 10	50	0584 9360 139	0584 8660 139
141.3 / 141.3	COMBI GRIP E 141.3 / 141.3	138.1-141.6	139.6-142.8	10	16	25	115	165	185	3.14	M 12 SW 10	50	0584 9360 141	0584 8660 141
160.0 / 159.0	COMBI GRIP E 159.0 / 160.0	159.0-162.0	157.3-160.7	10	16	35	115	180	200	3.45	M 12 SW 10	60	0584 9360 159	0584 8660 159
168.3 / 168.3	COMBI GRIP E 168.3 / 168.3	166.0-170.1	166.5-170.1	10	16	35	115	190	210	3.48	M 12 SW 10	60	0584 9360 168	0584 8660 168

NORMACONNECT® FGR COMBI GRIP														
Ø (O.D.)	Designation	Clamping ranges O _{dmin} - O _{dmax} (mm)		PN ¹ [bar]	WP ² [bar]	C max (mm)	Dimensions (approx.)			Weight (approx.) (kg/pc.)	Hex socket locking bolts		W5 Product No.	
		Plastic	Metal				a (mm)	d (mm)	H (mm)		Thread	Tightening torque (Nm)	EPDM	NBR
200.0 / 204.0	COMBI GRIP 200.0 / 204.0	198.0-202.0	202.0-206.0	-	16	35	142	235	265	7.5	M 12 SW 10	60	0584 8350 204	0584 8650 204
219.1 / 219.1	COMBI GRIP 219.1 / 219.1	217.0-222.0	216.0-221.0	-	16	35	142	250	280	7.9	M 12 SW 10	60	0584 8350 219	0584 8650 219
225.0 / 219.1	COMBI GRIP 225.0 / 219.1	222.0-227.0	216.0-221.0	-	10	35	142	255	285	8.1	M 12 SW 10	60	0584 8350 220	0584 8650 220
225.0 / 222.0	COMBI GRIP 225.0 / 222.0	222.0-227.0	220.0-224.0	-	10	35	142	255	285	8.1	M 12 SW 10	60	0584 8350 222	0584 8650 222
250.0 / 254.0	COMBI GRIP 250.0 / 254.0	247.0-253.0	250.0-256.0	-	10	35	142	285	315	8.6	M 12 SW 10	80	0584 8350 254	0584 8650 254
273.0 / 273.0	COMBI GRIP 273.0 / 273.0	271.0-276.0	270.0-275.0	-	10	35	142	305	335	9.1	M 16 SW 14	100	0584 8350 272	0584 8650 272
280.0 / 273.0	COMBI GRIP 280.0 / 273.0	277.0-283.0	270.0-275.0	-	10	35	142	310	340	9.3	M 16 SW 14	100	0584 8350 273	0584 8650 273
323.9 / 323.9	COMBI GRIP 323.9 / 323.9	320.0-327.0	320.0-327.0	-	6	35	142	355	385	10.2	M 16 SW 14	100	0584 8350 323	0584 8650 323
355.0 / 355.6	COMBI GRIP 355.0 / 355.6	351.0-359.0	352.0-359.0	-	6	35	142	390	420	10.9	M 16 SW 14	120	0584 8350 355	0584 8650 355
400.0 / 406.4	COMBI GRIP 400.0 / 406.4	396.0-404.0	402.0-410.0	-	6	35	142	440	470	11.9	M 16 SW 14	120	0584 8350 400	0584 8650 400
406.0 / 406.4	COMBI GRIP 406.0 / 406.4	396.0-404.0	402.0-410.0	-	6	35	142	440	470	12	M 16 SW 14	120	0584 8350 406	0584 8650 406

PN¹ (Nominal Pressure) is the max. admissible working pressure in shipbuilding, based on a safety factor of ≥ 4.

WP² is the max. working pressure in industrial applications, with a safety factor as per NORMA specification.

*Special coupling for joining metal pipes with PE-HD drainage pipes



Support sleeve to be used with NORMACONNECT® PLAST GRIP/PLAST GRIP E, COMBIGRIP/COMBI GRIP E in W5 (1.4571) material.

For copper and CuNiFe pipes an optional support sleeve made from brass is available on request.

NORMACONNECT®

Optional support sleeve

When joining plastic pipes made from PE and PP a support sleeve must be used. If the pipes to be joined are made from soft thermoplastic (e.g., PE) the use of a support sleeve is mandatory. The support sleeve is inserted into the pipe end within the area to be joined and thus protects the pipe from being deformed.

Technical data & Ordering information

INTERNAL SUPPORT SLEEVE FOR PLAST GRIP / PLAST GRIP E IN W5 (316TI)*												
PE	SDR 6		SDR 7,4		SDR 9		SDR 11		SDR 13,6		SDR 17	
Ø OD mm	Product No.	Ø mm	Product No.	Ø mm	Product No.	Ø mm	Product No.	Ø mm	Product No.	Ø mm	Product No.	Ø mm
40	0581 0006 040	26,6	0581 0007 040	29,0	0581 0009 040	31,0	0581 0011 040	32,6	0581 0013 040	34,0	0581 0017 040	35,2
50	0581 0006 050	33,4	0581 0007 050	36,2	0581 0009 050	38,8	0581 0011 050	40,8	0581 0013 050	42,6	0581 0017 050	44,0
63	0581 0006 063	42,0	0581 0007 063	45,8	0581 0009 063	48,8	0581 0011 063	51,4	0581 0013 063	53,6	0581 0017 063	55,4
75	0581 0006 075	50,0	0581 0007 075	54,4	0581 0009 075	58,2	0581 0011 075	61,4	0581 0013 075	63,8	0581 0017 075	66,0
90	0581 0006 090	60,0	0581 0007 090	65,4	0581 0009 090	69,8	0581 0011 090	73,6	0581 0013 090	76,6	0581 0017 090	79,2
110	0581 0006 110	73,4	0581 0007 110	79,8	0581 0009 110	85,4	0581 0011 110	90,0	0581 0013 110	93,8	0581 0017 110	96,8
125	0581 0006 125	83,4	0581 0007 125	90,8	0581 0009 125	97,0	0581 0011 125	102,2	0581 0013 125	106,6	0581 0017 125	110,2
140	0581 0006 140	93,4	0581 0007 140	101,6	0581 0009 140	108,6	0581 0011 140	114,6	0581 0013 140	119,4	0581 0017 140	123,4
160	0581 0006 160	106,8	0581 0007 160	116,2	0581 0009 160	124,2	0581 0011 160	130,8	0581 0013 160	136,4	0581 0017 160	141,0
180	0581 0006 180	120,2	0581 0007 180	130,8	0581 0009 180	139,8	0581 0011 180	147,2	0581 0013 180	153,4	0581 0017 180	158,6
200	0581 0006 200	133,6	0581 0007 200	145,2	0581 0009 200	155,2	0581 0011 200	163,6	0581 0013 200	170,6	0581 0017 200	176,2
225	0581 0006 225	150,2	0581 0007 225	163,4	0581 0009 225	174,6	0581 0011 225	184,0	0581 0013 225	191,8	0581 0017 225	198,2
250	0581 0006 250	167,0	0581 0007 250	181,6	0581 0009 250	194,2	0581 0011 250	204,6	0581 0013 250	213,2	0581 0017 250	220,4
280	0581 0006 280	187,0	0581 0007 280	203,4	0581 0009 280	217,4	0581 0011 280	229,2	0581 0013 280	238,8	0581 0017 280	246,8
315	0581 0006 315	210,4	0581 0007 315	228,8	0581 0009 315	244,6	0581 0011 315	257,8	0581 0013 315	268,6	0581 0017 315	277,6
355	0581 0006 355	237,0	0581 0007 355	258,0	0581 0009 355	275,6	0581 0011 355	290,6	0581 0013 355	302,8	0581 0017 355	312,8
400	0581 0006 400	267,0	0581 0007 400	290,6	0581 0003 400	310,6	0581 0011 400	327,4	0581 0013 400	341,2	0581 0017 400	352,6
450	-	-	0581 0007 450	-	0581 0009 450	-	0581 0011 450	-	0581 0013 450	-	0581 0017 450	-

Table continues on next page
 * SDR 5 available on request

Technical data & Ordering information

NORMACONNECT®

INTERNAL SUPPORT SLEEVE FOR PLAST GRIP / PLAST GRIP E IN W5 (316TI)														
PE	SDR 17.6		SDR 21		SDR 22		SDR 26		SDR 33		SDR 41		SDR 51	
Ø OD mm	Product No.	Ø mm	Product No.	Ø mm	Product No.	Ø mm	Product No.	Ø mm	Product No.	Ø mm	Product No.	Ø mm	Product No.	Ø mm
40	0581 0018 040	35,4	0581 0021 040	36,0	0581 0022 040	36,2	0581 0026 040	36,4	-	-	-	-	-	-
50	0581 0018 050	44,2	0581 0021 050	45,2	0581 0022 050	45,4	0581 0026 050	46	0581 0033 050	46,4	-	-	-	-
63	0581 0018 063	55,8	0581 0021 063	57,0	0581 0022 063	57,2	0581 0026 063	58	0581 0033 063	59	0581 0041 063	59,4	-	-
75	0581 0018 075	66,4	0581 0021 075	67,8	0581 0022 075	68,0	0581 0026 075	69,2	0581 0033 075	70,4	0581 0041 075	71,2	0581 0051 075	71,4
90	0581 0018 090	79,8	0581 0021 090	81,4	0581 0022 090	81,8	0581 0026 090	83,0	0581 0033 090	84,4	0581 0041 090	85,6	0581 0051 090	86,4
110	0581 0018 110	97,4	0581 0021 110	99,4	0581 0022 110	100,0	0581 0026 110	101,6	0581 0033 110	103,2	0581 0041 110	104,6	0581 0051 110	105,6
125	0581 0018 125	110,8	0581 0021 125	113,0	0581 0022 125	113,6	0581 0026 125	115,4	0581 0033 125	117,2	0581 0041 125	118,8	0581 0051 125	120,0
140	0581 0018 140	124,0	0581 0021 140	126,6	0581 0022 140	127,2	0581 0026 140	129,2	0581 0033 140	131,4	0581 0041 140	133,0	0581 0051 140	134,4
160	0581 0018 160	141,8	0581 0021 160	144,6	0581 0022 160	145,4	0581 0026 160	147,6	0581 0033 160	150,2	0581 0041 160	152,0	0581 0051 160	153,6
180	0581 0018 180	159,6	0581 0021 180	162,8	0581 0022 180	163,6	0581 0026 180	166,2	0581 0033 180	169,0	0581 0041 180	171,2	0581 0051 180	172,8
200	0581 0018 200	177,2	0581 0021 200	180,8	0581 0022 200	181,8	0581 0026 200	184,6	0581 0033 200	187,6	0581 0041 200	190,2	0581 0051 200	192,2
225	0581 0018 225	199,4	0581 0021 225	203,4	0581 0022 225	204,4	0581 0026 225	207,8	0581 0033 225	211,2	0581 0041 225	214,0	0581 0051 225	216,2
250	0581 0018 250	221,6	0581 0021 250	226,2	0581 0022 250	227,2	0581 0026 250	230,8	0581 0033 250	234,6	0581 0041 250	237,6	0581 0051 250	240,2
280	0581 0018 280	248,2	0581 0021 280	253,2	0581 0022 280	254,4	0581 0026 280	258,6	0581 0033 280	262,8	0581 0041 280	266,2	0581 0051 280	269,0
315	0581 0018 315	279,2	0581 0021 315	285,0	0581 0022 315	286,2	0581 0026 315	290,8	0581 0033 315	295,6	0581 0041 315	299,6	0581 0051 315	302,6
355	0581 0018 355	314,8	0581 0021 355	321,2	0581 0022 350	322,6	0581 0026 355	327,8	0581 0033 355	333,2	0581 0041 355	337,6	0581 0051 355	341,0
400	0581 0018 400	354,6	0581 0021 400	361,8	0581 0022 400	363,6	0581 0026 400	369,4	0581 0033 400	375,4	0581 0041 400	380,4	0581 0051 400	384,2
450	0581 0018 450	399,0	0581 0021 450	407,0	0581 0022 450	409,0	0581 0026 450	415,6	0581 0033 450	422,4	0581 0041 450	428,0	0581 0051 450	432,4

INTERNAL SUPPORT SLEEVE FOR PLAST GRIP / PLAST GRIP E IN W5 (316TI)*								
PP	SDR 6		SDR 7,4		SDR 9		SDR 11	
Ø OD mm	Product No.	Ø mm	Product No.	Ø mm	Product No.	Ø mm	Product No.	Ø mm
40	0581 1006 040	26,6	0581 1007 040	29,0	0581 1009 040	31,0	0581 1011 040	32,6
50	0581 1006 050	33,4	0581 1007 050	36,2	0581 1009 050	38,8	0581 1011 050	40,8
63	0581 1006 063	42,0	0581 1007 063	45,8	0581 1009 063	48,8	0581 1011 063	51,4
75	0581 1006 075	50,0	0581 1007 075	54,4	0581 1009 075	58,2	0581 1011 075	61,4
90	0581 1006 090	60,0	0581 1007 090	65,4	0581 1009 090	69,8	0581 1011 090	73,6
110	0581 1006 110	73,4	0581 1007 110	79,8	0581 1009 110	85,4	0581 1011 110	90,0
125	0581 1006 125	83,4	0581 1007 125	90,8	0581 1009 125	97,0	0581 1011 125	102,2
140	0581 1006 140	93,4	0581 1007 140	101,6	0581 1009 140	108,6	0581 1011 140	114,6
160	0581 1006 160	106,8	0581 1007 160	116,2	0581 1009 160	124,2	0581 1011 160	130,8
180	0581 1006 180	122,0	0581 1007 180	130,8	0581 1009 180	139,8	0581 1011 180	147,2
200	0581 1006 200	133,6	0581 1007 200	145,2	0581 1009 200	155,2	0581 1011 200	163,6
225	0581 1006 225	150,2	0581 1007 225	163,4	0581 1009 225	174,6	0581 1011 225	184,0
250	-	-	0581 1007 250	181,6	0581 1009 250	194,2	0581 1011 250	204,6
280	-	-	0581 1007 280	203,4	0581 1009 280	217,4	0581 1011 280	229,2
315	-	-	-	-	0581 1009 315	244,6	0581 1011 315	257,8
355	-	-	-	-	0581 1009 355	275,6	0581 1011 355	290,6
400	-	-	-	-	-	-	0581 1011 400	327,4
450	-	-	-	-	-	-	0581 1011 450	368,2

* SDR 5 available on request

INTERNAL SUPPORT SLEEVE FOR PLAST GRIP / PLAST GRIP E IN W5 (316TI)										
PP	SDR 17		SDR 17,6		SDR 26		SDR 33		SDR 41	
Ø OD mm	Product No.	Ø mm	Product No.	Ø mm	Product No.	Ø mm	Product No.	Ø mm	Product No.	Ø mm
40	0581 1017 040	35,2	0581 1018 040	35,4	0581 1026 040	36,4	-	-	-	-
50	0581 1017 050	44,0	0581 1018 050	44,2	0581 1026 050	46,0	0581 1033 050	46,4	-	-
63	0581 1017 063	55,4	0581 1018 063	55,8	0581 1026 063	58,0	0581 1033 063	59,0	0581 1041 063	59,4
75	0581 1017 075	66,0	0581 1018 075	66,4	0581 1026 075	69,2	0581 1033 075	70,4	0581 1041 075	71,2
90	0581 1017 090	79,2	0581 1018 090	79,8	0581 1026 090	83,0	0581 1033 090	84,4	0581 1041 090	85,6
110	0581 1017 110	96,8	0581 1018 110	97,4	0581 1026 110	101,6	0581 1033 110	103,2	0581 1041 110	104,6
125	0581 1017 125	110,2	0581 1018 125	110,8	0581 1026 125	115,4	0581 1033 125	117,2	0581 1041 125	118,8
140	0581 1017 140	123,4	0581 1018 140	124,0	0581 1026 140	129,2	0581 1033 140	131,4	0581 1041 140	133,0
160	0581 1017 160	141,0	0581 1018 160	141,8	0581 1026 160	147,6	0581 1033 160	150,2	0581 1041 160	152,0
180	0581 1017 180	158,6	0581 1018 180	159,6	0581 1026 180	166,2	0581 1033 180	169,0	0581 1041 180	171,2
200	0581 1017 200	176,2	0581 1018 200	177,2	0581 1026 200	184,6	0581 1033 200	187,6	0581 1041 200	190,2
225	0581 1017 225	198,2	0581 1018 225	199,4	0581 1026 225	207,8	0581 1033 225	211,2	0581 1041 225	214,0
250	0581 1017 250	220,4	0581 1018 250	221,6	0581 1026 250	230,8	0581 1033 250	234,6	0581 1041 250	237,6
280	0581 1017 280	246,8	0581 1018 280	248,2	0581 1026 280	258,6	0581 1033 280	262,8	0581 1041 280	266,2
315	0581 1017 315	277,6	0581 1018 315	279,2	0581 1026 315	290,8	0581 1033 315	295,6	0581 1041 315	299,6
355	0581 1017 355	312,8	0581 1018 355	314,8	0581 1026 355	327,8	0581 1033 355	333,2	0581 1041 355	337,6
400	0581 1017 400	352,6	0581 1018 400	354,6	0581 1026 400	369,4	0581 1033 400	375,4	0581 1041 400	380,4
450	0581 1017 450	396,6	0581 1018 450	399,0	0581 1026 450	415,6	0581 1033 450	422,4	0581 1041 450	428,0

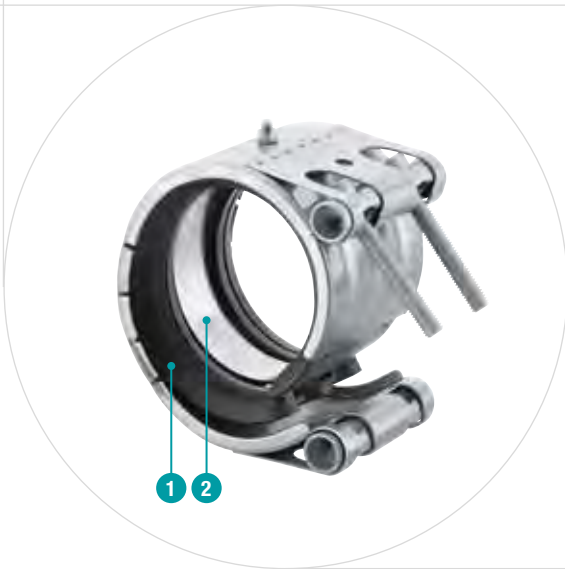

- 1 Double-lip sealing system
- 2 Standard strip insert

The repair coupling

NORMACONNECT® REP E are non-restraint repair couplings. They are used to seal damaged metal and plastic pipes. They also enable repairs to be carried out easily, quickly and safely without the need to dismantle the pipes.

Advantages at a glance

- Ensures a reliable, safe, leakage-free connection
- Enables easy, quick and safe repair without dismantling the pipes
- Easy to install without special tools

Information

- Sizes: from 35.0 mm to 1219.1 mm
- Working pressure: from 60.0 bar to 4.0 bar
- Material: AISI 316 Ti
- EPDM:
 - Sizes from 26.9 mm up to 168.3 mm: - 30 °C up to + 125 °C
 - Sizes > 180.0 mm: - 20 °C up to + 80 °C
- NBR : from - 20 °C up to + 80 °C

Materials

W1	W2	W3	W4	W5
				x

Technical data & Ordering information

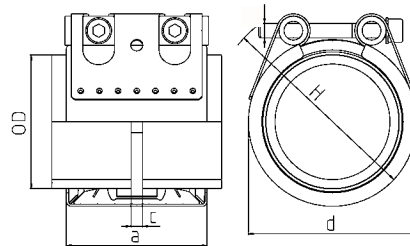

Technical data & Ordering information

NORMACONNECT®

NORMACONNECT® FGR REP E													
Ø (O.D.)	Designation	Clamping ranges	WP ¹	C max	Dimensions (approx.)			Weight (approx.)	Hex socket locking bolts		W5 Product No.		
		O _{min} - O _{max}	 [bar]	(mm)	a (mm)	d (mm)	H (mm)	(kg/pc.)	Thread	Tightening torque (Nm)	EPDM	NBR	
35.0	REP E W5 35.0	34.5 - 35.6	60	8	63	55	75	0.41	M 8 SW 6	5	0572 9360 035	0572 8660 035	
38.0	REP E W5 38.0	37.5 - 38.6	60	8	63	60	80	0.41	M 8 SW 6	5	0572 9360 038	0572 8660 038	
42.4	REP E W5 42.4	41.7 - 43.0	50	8	63	65	85	0.42	M 8 SW 6	5	0572 9360 042	0572 8660 042	
44.5	REP E W5 44.5	44.0 - 45.1	50	8	63	65	85	0.43	M 8 SW 6	5	0572 9360 044	0572 8660 044	
48.3	REP E W5 48.3	47.6 - 50.5	50	8	63	70	90	0.44	M 8 SW 6	5	0572 9360 048	0572 8660 048	
54.0	REP E W5 54.0	53.3 - 54.6	50	17	78	75	95	0.58	M 8 SW 6	10	0572 9360 054	0572 8660 054	
57.0	REP E W5 57.0	56.3 - 57.7	50	17	78	80	100	0.58	M 8 SW 6	10	0572 9360 057	0572 8660 057	
60.3	REP E W5 60.3	59.5 - 61.0	40	17	78	85	105	0.59	M 8 SW 6	10	0572 9360 060	0572 8660 060	
70.0	REP E W5 70.0	69.0 - 71.0	40	25	98	90	110	0.59	M 8 SW 6	10	0572 9360 070	0572 8660 070	
73.0	REP E W5 73.0	72.1 - 73.8	40	25	98	95	115	1.13	M 8 SW 6	10	0572 9360 073	0572 8660 073	
76.1	REP E W5 76.1	75.2 - 77.0	35	25	98	100	120	1.13	M 8 SW 6	10	0572 9360 076	0572 8660 076	
78.0	REP E W5 78.0	77.1 - 78.9	35	25	98	100	120	1.14	M 8 SW 6	15	0572 9360 078	0572 8660 078	
80.0	REP E W5 80.0	79.0 - 80.8	35	25	98	100	120	1.16	M 8 SW 6	15	0572 9360 080	0572 8660 080	
84.0	REP E W5 84.0	83.0 - 85.0	35	25	98	105	125	1.18	M 8 SW 6	15	0572 9360 084	0572 8660 084	
88.9	REP E W5 88.9	87.0 - 89.9	35	25	98	110	130	1.20	M 8 SW 6	15	0572 9360 088	0572 8660 088	
98.0	REP E W5 98.0	96.9 - 99.0	35	25	98	120	140	1.32	M 8 SW 6	15	0572 9360 098	0572 8660 098	
101.6	REP E W5 101.6	100.4 - 102.8	35	25	98	125	145	1.33	M 8 SW 6	15	0572 9360 101	0572 8660 101	
104.0	REP E W5 104.0	102.8 - 106.1	35	25	98	125	145	1.36	M 8 SW 6	15	0572 9360 104	0572 8660 104	
108.0	REP E W5 108.0	106.8 - 109.2	35	25	98	130	150	1.40	M 8 SW 6	15	0572 9360 108	0572 8660 108	
110.0	REP E W5 110.0	108.8 - 111.4	35	25	98	130	150	1.40	M 8 SW 6	20	0572 9360 110	0572 8660 110	
114.3	REP E W5 114.0	113.0 - 115.5	35	25	98	135	155	1.99	M 8 SW 6	30	0572 9360 114	0572 8660 114	
129.0	REP E W5 129.0	127.6 - 131.1	32	35	113	155	185	2.00	M 10 SW 8	30	0572 9360 129	0572 8660 129	
133.0	REP E W5 133.0	131.5 - 134.4	32	35	113	160	190	2.03	M 10 SW 8	30	0572 9360 133	0572 8660 133	
139.7	REP E W5 139.7	138.1 - 141.6	32	35	113	165	195	2.08	M 10 SW 8	30	0572 9360 139	0572 8660 139	
141.3	REP E W5 141.3	139.6 - 142.8	32	35	113	170	200	2.09	M 10 SW 8	35	0572 9360 141	0572 8660 141	
154.0	REP E W5 154.0	152.3 - 156.1	32	35	113	180	210	2.19	M 10 SW 8	50	0572 9360 154	0572 8660 154	
159.0	REP E W5 159.0	157.3 - 160.7	32	35	113	185	215	2.26	M 10 SW 8	50	0572 9360 159	0572 8660 159	
168.3	REP E W5 168.0	166.5 - 170.1	32	35	113	195	225	2.31	M 10 SW 8	50	0572 9360 168	0572 8660 168	
180.0	REP E W5 180.0	178.0 - 182.0	30.0	35	139	210	240	4.0	M 12 SW 10	25	0576 8360 ...	0576 8660 ...	
193.7	REP E W5 193.7	192.0 - 196.0	28.0	35	139	225	255	4.1	M 12 SW 10	25	0576 8360 ...	0576 8660 ...	
206.0	REP E W5 206.0	202.0 - 208.0	26.5	35	139	240	270	4.3	M 12 SW 10	25	0576 8360 ...	0576 8660 ...	
219.0	REP E W5 219.0	216.0 - 221.0	23.0	35	139	250	280	4.4	M 12 SW 10	25	0576 8360 ...	0576 8660 ...	
225.0	REP E W5 225.0	222.0 - 227.0	23.0	35	139	255	285	4.5	M 12 SW 10	25	0576 8360 ...	0576 8660 ...	
229.9	REP E W5 229.9	228.0 - 232.0	23.0	35	139	260	290	4.5	M 12 SW 10	25	0576 8360 ...	0576 8660 ...	
244.5	REP E W5 244.5	242.0 - 247.0	22.0	35	139	275	305	4.7	M 12 SW 10	25	0576 8360 ...	0576 8660 ...	
254.0	REP E W5 254.0	250.0 - 256.0	21.0	35	139	285	315	4.8	M 12 SW 10	25	0576 8360 ...	0576 8660 ...	
267.0	REP E W5 267.0	264.0 - 269.0	20.0	35	139	300	330	5.0	M 12 SW 10	25	0576 8360 ...	0576 8660 ...	
273.0	REP E W5 273.0	270.0 - 275.0	20.0	35	139	305	335	5.1	M 12 SW 10	25	0576 8360 ...	0576 8660 ...	
306.0	REP E W5 306.0	302.0 - 308.0	17.5	35	139	340	370	5.5	M 12 SW 10	25	0576 8360 ...	0576 8660 ...	
323.9	REP E W5 323.9	320.0 - 327.0	17.5	35	139	355	385	5.7	M 12 SW 10	25	0576 8360 ...	0576 8660 ...	
326.0	REP E W5 326.0	322.0 - 329.0	16.5	35	139	360	390	5.7	M 12 SW 10	25	0576 8360 ...	0576 8660 ...	
355.6	REP E W5 355.6	352.0 - 359.0	15.0	35	139	390	420	6.0	M 12 SW 10	25	0576 8360 ...	0576 8660 ...	
406.4	REP E W5 406.4	402.0 - 410.0	14.0	35	139	440	470	6.6	M 12 SW 10	25	0576 8360 ...	0576 8660 ...	
429.0	REP E W5 429.0	426.0 - 431.0	13.0	35	139	460	490	6.9	M 12 SW 10	40	0576 8360 ...	0576 8660 ...	
442.0	REP E W5 442.0	439.0 - 444.0	13.0	35	139	475	505	7.1	M 12 SW 10	40	0576 8360 ...	0576 8660 ...	
457.2	REP E W5 457.2	454.0 - 459.0	12.0	35	139	490	520	7.3	M 12 SW 10	40	0576 8360 ...	0576 8660 ...	
508.0	REP E W5 508.0	505.0 - 510.0	11.0	35	139	540	570	7.9	M 12 SW 10	40	0576 8360 ...	0576 8660 ...	
531.0	REP E W5 531.0	528.0 - 534.0	10.5	35	139	565	595	8.1	M 12 SW 10	40	0576 8360 ...	0576 8660 ...	
558.8	REP E W5 558.8	556.0 - 562.0	10.0	35	139	590	620	8.5	M 12 SW 10	40	0576 8360 ...	0576 8660 ...	
609.6	REP E W5 609.6	606.0 - 613.0	9.0	35	139	640	670	9.1	M 12 SW 10	40	0576 8360 ...	0576 8660 ...	
634.0	REP E W5 634.0	631.0 - 637.0	8.0	35	139	665	695	9.4	M 12 SW 10	40	0576 8360 ...	0576 8660 ...	
711.2	REP E W5 711.2	707.0 - 715.0	7.0	35	139	745	775	10.3	M 12 SW 10	40	0576 8360 ...	0576 8660 ...	
762.0	REP E W5 762.0	758.0 - 766.0	7.0	35	139	795	825	10.9	M 12 SW 10	40	0576 8360 ...	0576 8660 ...	
812.8	REP E W5 812.8	808.0 - 817.0	6.5	35	139	845	875	11.5	M 12 SW 10	40	0576 8360 ...	0576 8660 ...	
914.4	REP E W5 914.4	909.0 - 919.0	5.5	35	139	945	975	12.7	M 12 SW 10	45	0576 8360 ...	0576 8660 ...	
1016.0	REP E W5 1016.0	1013.0 - 1019.0	5.0	35	139	1050	1080	13.9	M 12 SW 10	45	0576 8360 ...	0576 8660 ...	
1117.5	REP E W5 1117.5	1114.0 - 1120.0	4.5	35	139	1150	1180	15.1	M 12 SW 10	50	0576 8360 ...	0576 8660 ...	
1219.2	REP E W5 1219.2	1216.0 - 1222.0	4.0	35	139	1250	1280	16.3	M 12 SW 10	50	0576 8360 ...	0576 8660 ...	

Coupling sizes >800 mm are in 2-parts design! Sizes > 1219.2 on request
 ... = Ø without decimals in mm



Refer to page 196.



- 1 Installation handle
- 2 SS Bridge
- 3 EPDM Gasket
- 4 SS Housing

NEW!

NORMACONNECT®
NEW

First-Aid for damaged pipes

The NORMACONNECT® First-Aid Repair Clamp is ideal for repairing pipes damaged with cracks, holes, splits, pin holes etc. in all kinds of steel, cast iron, copper, plastic and concrete pipes, transporting liquid media and non-flammable gases up to 115 °C.

Advantages at a glance

- Quick installation - Minimizes down time for damaged water pipes and pressurized mains
- Durable materials - Corrosion-resistant stainless steel with full circle EPDM rubber gasket
- Versatile fittings – Sophisticated design ensures that each size can securely seal a range of pipe sizes and materials
- Economical – Faster and more cost-effective than replacing entire sections of pipe immediately
- Certifications – Pressure tested according to DVGW W336 norms, EPDM gasket according to DIN EN 681.1 standard, gasket tested according to European Elastomer specification (former KTW and W270 standard)

Materials

W1	W2	W3	W4	W5
			x	

Information

- Sizes: 59-70 mm up to 396-407 mm
- Working pressure: 10-16 bar
- Materials: Housing AISI 304, Gasket EPDM
- Working temperature: Up to 115 °C

Technical data & Ordering information

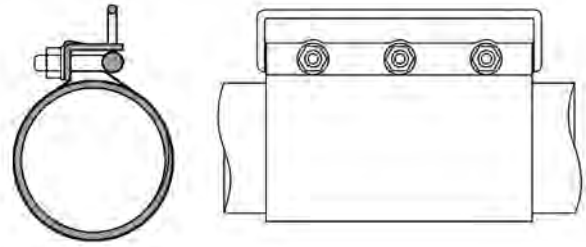

NORMA® FIRST-AID REPAIR CLAMP

Designation	Clamping ranges	Length (mm)	PN (bar)	Bolt diameter	Max. tightening torque (Nm)	Weight (kg/pc.)	W4 Product No.
FIRST-AID REPAIR CLAMP K-63	59-70	100	16	M12 SW19	100	0,8	0572 2211 063
FIRST-AID REPAIR CLAMP M-63	59-70	200	16	M12 SW19	100	1,6	0572 2212 063
FIRST-AID REPAIR CLAMP K-68	63-72	100	16	M12 SW19	100	0,8	0572 2211 068
FIRST-AID REPAIR CLAMP M-68	63-72	200	16	M12 SW19	100	1,7	0572 2212 068
FIRST-AID REPAIR CLAMP K-75	70-81	100	16	M12 SW19	100	0,9	0572 2211 075
FIRST-AID REPAIR CLAMP M-75	70-81	200	16	M12 SW19	100	1,7	0572 2212 075
FIRST-AID REPAIR CLAMP K-82	82-91	100	16	M12 SW19	100	1,0	0572 2211 082
FIRST-AID REPAIR CLAMP M-82	82-91	200	16	M12 SW19	100	1,8	0572 2212 082
FIRST-AID REPAIR CLAMP K-104	104-114	100	16	M12 SW19	100	1,2	0572 2211 104
FIRST-AID REPAIR CLAMP M-104	104-114	210	16	M12 SW19	100	2,1	0572 2212 104
FIRST-AID REPAIR CLAMP L-104	104-114	315	16	M12 SW19	100	3,4	0572 2213 104
FIRST-AID REPAIR CLAMP K-131	128-140	200	16	M16 SW24	130	2,8	0572 2211 131
FIRST-AID REPAIR CLAMP M-131	128-140	250	16	M16 SW24	130	3,7	0572 2212 131
FIRST-AID REPAIR CLAMP L-131	128-140	315	16	M16 SW24	130	4,7	0572 2213 131
FIRST-AID REPAIR CLAMP K-140	138-150	200	16	M16 SW24	130	3,1	0572 2211 140
FIRST-AID REPAIR CLAMP M-140	138-150	250	16	M16 SW24	130	4,0	0572 2212 140
FIRST-AID REPAIR CLAMP L-140	138-150	315	16	M16 SW24	130	5,0	0572 2213 140
FIRST-AID REPAIR CLAMP K-151	150-162	200	16	M16 SW24	130	3,2	0572 2211 151
FIRST-AID REPAIR CLAMP M-151	150-162	250	16	M16 SW24	130	4,2	0572 2212 151
FIRST-AID REPAIR CLAMP L-151	150-162	315	16	M16 SW24	130	5,2	0572 2213 151
FIRST-AID REPAIR CLAMP K-166	163-175	200	16	M16 SW24	130	3,4	0572 2211 166
FIRST-AID REPAIR CLAMP M-166	163-175	250	16	M16 SW24	130	4,4	0572 2212 166
FIRST-AID REPAIR CLAMP L-166	163-175	315	16	M16 SW24	130	5,4	0572 2213 166
FIRST-AID REPAIR CLAMP K-178	178-192	200	16	M16 SW24	130	3,5	0572 2211 178
FIRST-AID REPAIR CLAMP M-178	178-192	250	16	M16 SW24	130	4,5	0572 2212 178
FIRST-AID REPAIR CLAMP L-178	178-192	315	16	M16 SW24	130	5,6	0572 2213 178
FIRST-AID REPAIR CLAMP K-190	191-202	200	10	M16 SW24	130	3,5	0572 2211 190
FIRST-AID REPAIR CLAMP M-190	191-202	250	10	M16 SW24	130	4,6	0572 2212 190
FIRST-AID REPAIR CLAMP L-190	191-202	315	10	M16 SW24	130	5,8	0572 2213 190
FIRST-AID REPAIR CLAMP M-215	215-226	250	10	M16 SW24	130	4,7	0572 2212 215
FIRST-AID REPAIR CLAMP L-215	215-226	315	10	M16 SW24	130	6,2	0572 2213 215
FIRST-AID REPAIR CLAMP M-225	220-230	250	10	M16 SW24	130	5,2	0572 2212 225
FIRST-AID REPAIR CLAMP L-225	220-230	315	10	M16 SW24	130	6,5	0572 2213 225
FIRST-AID REPAIR CLAMP M-260	251-261	250	10	M16 SW24	130	5,6	0572 2212 260
FIRST-AID REPAIR CLAMP L-260	251-261	315	10	M16 SW24	130	7,0	0572 2213 260
FIRST-AID REPAIR CLAMP M-269	269-281	250	10	M16 SW24	130	5,4	0572 2212 269
FIRST-AID REPAIR CLAMP M-306	306-316	315	10	M16 SW24	130	7,2	0572 2212 306
FIRST-AID REPAIR CLAMP L-306	306-316	575	10	M16 SW24	130	13,1	0572 2213 306
FIRST-AID REPAIR CLAMP M-315	314-325	315	10	M16 SW24	130	7,4	0572 2212 315
FIRST-AID REPAIR CLAMP L-315	314-325	575	10	M16 SW24	130	13,3	0572 2213 315
FIRST-AID REPAIR CLAMP M-345	345-357	315	10	M16 SW24	130	7,8	0572 2212 345
FIRST-AID REPAIR CLAMP L-345	345-357	575	10	M16 SW24	130	14,2	0572 2213 345
FIRST-AID REPAIR CLAMP M-400	396-407	315	10	M16 SW24	130	8,5	0572 2212 400
FIRST-AID REPAIR CLAMP L-400	396-407	575	10	M16 SW24	130	15,5	0572 2213 400

The maximum tightening torque should not be exceeded. The bolts should be tightened until the leakage is visibly sealed.



Certificates, Liability, Memberships

Certificates Materialprüfungsamt Nordrhein-Westfalen (MPA NRW)

Liability Product liability: In case of bodily injury and/or material damage.

Memberships IZEG – Informationszentrum Entwässerungstechnik Guss
GEG – Gütergemeinschaft Entwässerungstechnik Guss



Informationszentrum
Entwässerungstechnik Guss e.V.













Materials at a glance

MATERIALS FOR CONNECTORS AND CLAWS				
	COLLAR	CLAMPING UNIT	SCREWS, NUTS, BOLTS	SEALING SLEEVE
W1			Steel, protected surface	–
W2	AISI 430 Ti	AISI 304	Steel, protected surface	EPDM
W4	AISI 304	AISI 304	AISI 304	EPDM
W5	AISI 316 Ti	AISI 316 Ti	AISI 316	EPDM

	COLLAR	CLAMPING UNIT	SCREWS	SEALING SLEEVE
W2	AISI 304	Steel, protected surface	Steel, protected surface	EPDM
W5	AISI 316 Ti	AISI 316 Ti	AISI 316	EPDM

Products and Application at a glance

TYPE	DN AND PRESSURE [bar]																SEAL TYPE	MATERIAL	APPLICATION		
	40	50	70	75	75 S	75/80	100	125	150	200	250	300	400	500	600	STANDARD			Buildings	Bridges	Soil
NON-PULL-OUT RESISTANT CONNECTIONS																					
RAPID 	•	•	•			•	•	•	•	•							EPDM	W 2	•	-	-
RAPID 	•	•	•			•	•	•	•	•	•	•					EPDM	W 5	•	•	•
MSM 																					
RAPID 		•	•			•	•	•	•	•							EPDM	W 2	•	-	-
CV 		•	•			•	•	•	•	•	•	•					EPDM	W 2	•	-	-
CE 		•	•					•	•	•	•	•					EPDM	W 4	•	-	•*
SVE 		•				•	•	•	•	•							NR-SBR	PP-CO	-	-	•
PULL-OUT RESISTANT CONNECTIONS																					
UNIVERSAL Claw ** 		10	10			10	10	10	5	5	3	3					-	W 2	•	-	-
RECORD Claw ** 	10	10	10			10	10	5	5	3							-	W 1	•	-	-
COMBI Claw ** 		10	10			10	10	5	5								-	W 1	•	-	-
CHANGEOVER CONNECTORS																					
CONFIX 		•	•			•	•	•									EPDM	-	•	-	-

* Additional protection against corrosion * NBR on request Technical Changes reserved

** The claws are only suitable for open drainage systems. It is not allowed for use in closed pressure systems.





- 1 Hexagonal socket bolt with washer
- 2 Square nut
- 3 Closure unit
- 4 Collar
- 5 Sealing sleeve

The original Rapid with block tightening

The NORMACONNECT® DCS RAPID with block tightening for non-pull-out resistant connections enables a fast connection. The visible torque control and the single-bolt closure provide for a fast and easy installation.

Materials

W1	W2	W3	W4	W5
	x			x

W2

- Material, Collar: AISI 430 Ti
- Material, Clamping unit: AISI 304 / AISI 430 Ti
- Material, Bolts/Nuts: Steel, surface protected
- Material, Sealing sleeve: EPDM

W5

- Material, Collar: AISI 316Ti
- Material, Clamping unit: AISI 316Ti
- Material, Bolts/Nuts, Steel, surface protected
- Material, Sealing sleeve: EPDM

Information

- Resisting axial pull-out forces up to max. 0.5 bar
- DN 40 – DN 200
- Resisting axial pull-out forces up to max 0.3 bar
- DN 250 – DN 300
- Defined locking torque without using a special tool
- Meeting the fire protection requirements

Technical data & Ordering information

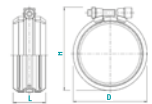

NORMACONNECT® DCS RAPID

Designation	Max. Dimensions after Assembly ~							W2 Product No.	W5 Product No.
	DN	D (mm)	H (mm)	L (mm)	P max (bar)	Torque (Nm)	Bolt (mm)		
RAPID DN 40	40	53	64	50	0.5	Tight-Locking	M 5	0245 8254 040	
RAPID DN 50	50	70	80	46	0.5	Tight-Locking	M 8	0245 8218 050	0245 8126 050
RAPID DN 70	70	90	100	43	0.5	Tight-Locking	M 8	0245 8219 070	0245 8127 070
RAPID DN 75 S	75	87	97	40.5	0.5	Tight-Locking	M 8	0245 8265 075	
RAPID DN 80	75/80	95	105	40	0.5	Tight-Locking	M 8	0245 8220 080	0245 8129 075
RAPID DN 100	100	125	135	39.0	0.5	Tight-Locking	M 8	0245 8221 100	0245 8130 100
RAPID DN 125	125	147	162	37.0	0.5	Tight-Locking	M 8	0245 8222 125	0245 8131 125
RAPID DN 150	150	172	187	35.5	0.5	Tight-Locking	M 8	0245 8223 150	0245 8132 150
RAPID DN 200	200	227	244	33.5	0.5	Tight-Locking	M 10	0245 8224 200	0245 8133 200
RAPID DN 250	250	293	306	96	0.3	Tight-Locking	M 10		0245 8208 250
RAPID DN 300	300	345	360	96	0.3	Tight-Locking	M 10		0245 8209 300



- 1 Hexagonal socket bolt with washer
- 2 Square nut
- 3 Closure unit
- 4 Collar
- 5 Sealing sleeve

The fast connection with quick release closure

The NORMACONNECT® DCS RAPID MSM connection is easy-fitting and thus especially suitable for repair purposes. It is the fast connection with quick release closure for non-pull-out resistant connections.



Materials

W1	W2	W3	W4	W5
	x			

- W2**
- Material, Collar: AISI 430 Ti
 - Material, Clamping unit: AISI 304 / AISI 430 Ti
 - Material, Bolts/Nuts: Steel, surface protected
 - Material, Sealing sleeve: EPDM

Information

- Resisting axial pull-out forces up to max. 0.5 bar
- Defined locking torque without using a special tool
- Meeting the fire protection requirements

Technical data & Ordering information

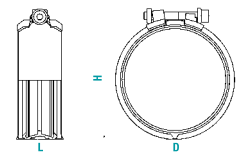

NORMACONNECT® DCS RAPID MSM									
Designation	Max. Dimensions after Assembly ~							W2 Product No.	
	DN	D (mm)	H (mm)	L (mm)	P max (bar)	Torque (Nm)	Bolt (mm)		
RAPID DN 50 MSM	50	70	80	40	0.5	Tight-Locking	M 8	0245 8257 050	
RAPID DN 70 MSM	70	90	100	40	0.5	Tight-Locking	M 8	0245 8258 070	
RAPID DN 80 MSM	75/80	95	105	40	0.5	Tight-Locking	M 8	0245 8260 080	
RAPID DN 100 MSM	100	125	135	46	0.5	Tight-Locking	M 8	0245 8261 100	
RAPID DN 125 MSM	125	147	162	55	0.5	Tight-Locking	M 8	0245 8262 125	
RAPID DN 150 MSM	150	172	187	55	0.5	Tight-Locking	M 8	0245 8263 150	
RAPID DN 200 MSM	200	227	244	70	0.5	Tight-Locking	M 10	0245 8264 200	



- 1 **CV: Slotted hexagonal head bolts**
DN 50 – DN 300: SW 10
CE: Hexagonal head bolts
DN 50, 70, 75/80: SW 10
DN 100 – DN 300: SW 13
- 2 **Guide plate**
- 3 **Threaded plate**
- 4 **Collar**
- 5 **Sealing sleeve**

Phase out

The proven standard collar

The NORMACONNECT® DCS CV/CE collar has been proven in all kinds of standard drainage applications. The proven standard collar for non-pull-out connections.

Materials

W1	W2	W3	W4	W5
	x		x	

- W2**
- Material, Collar: AISI 430 Ti
- Type CV**
- Material, Clamping unit: Steel, surface protected
 - Material, Sealing sleeve: EPDM
- W4**
- Material, Collar: AISI 304
- Type CE**
- Material, Clamping unit: AISI 304
 - Material, Sealing sleeve: EPDM
 - Material, Bolts: Steel, surface protected

Advantages at a glance

- Fast and easy installation
- Suitable for repair purposes

Important notice

- Product will be phased out
- Please contact your Area Sales Manager to check availability
- Preferred alternative product: NORMACONNECT® DCS RAPID (see page 15)

Technical data & Ordering information

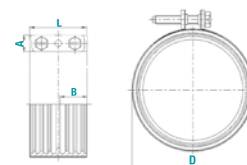

NORMACONNECT® DCS CV								
Designation	DN	A (mm)	B (mm)	D (mm)	L (mm)	Torque (Nm)	Bolt (mm)	W2 Product No.
CV DN 50	50	14	22.5	65	48	4-6	M 6	0242 8091 050
CV DN 70	70	14	22.5	85	48	4-6	M 6	0242 8092 070
CV DN 80	75/80	14	22.5	90	48	6-8	M 6	0242 8093 075
CV DN 100	100	18	22.5	115	54	10-12	M 8	0262 8303 100
CV DN 125	125	18	31	140	65	10-12	M 8	0262 8304 125
CV DN 150	150	18	31	170	65	10-12	M 8	0262 8305 150
CV DN 200	200	18	37	220	78	15-20	M 8	0262 8306 200
CV DN 250	250	18	37	286	78	15-20	M 8	0262 8307 250
CV DN 300	300	18	37	338	78	15-20	M 8	0262 8308 300

DCS CV is also available with a round hexagonal head bolt on request.

NORMACONNECT® DCS CE								
Designation	DN	A (mm)	B (mm)	D (mm)	L (mm)	Torque (Nm)	Bolt (mm)	W4 Product No.
CE DN 50	50	14	22.5	65	48	4-6	M 6	0242 8108 050
CE DN 70	70	14	22.5	85	48	4-6	M 6	0242 8109 070
CE DN 100	100	18	22.5	115	54	10-12	M 8	0262 8361 100
CE DN 125	125	18	31	140	65	10-12	M 8	0262 8362 125
CE DN 150	150	18	31	170	65	10-12	M 8	0262 8363 150
CE DN 200	200	18	37	220	78	15-20	M 8	0262 8364 200
CE DN 250	250	18	37	286	78	15-20	M 8	0262 8365 250
CE DN 300	300	18	37	338	78	15-20	M 8	0262 8366 300

DCS CE is also available with a round hexagonal head bolt on request.



- 1 Housing
- 2 Sealing lips

The collar for buried drainage pipes

Used to achieve fast and easy connection of below ground drainage pipes, while also accommodating larger gaps between pipe ends. The **NORMACONNECT®** DCS SVE collar for buried drainage pipes and other non-pull-out connections is the universal solution for many applications.

Materials

- Material, Housing: Polypropylene-CO
- Material, Seal: NR-SBR

Information

- Collar made from polypropylene with built-in sealing lips
- Compensates for larger gaps between pipe ends

Technical data & Ordering information

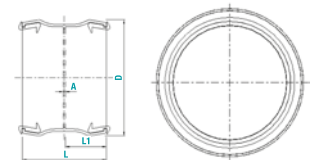

NORMACONNECT® DCS SVE CONNECTION, PP-CO with built-in sealing lips NR-SBR

Designation	DN	D (mm)	L (mm)	L' (mm)	A (mm)	Polypropylene-CO Product No.
DCS SVE DN 50	50	77	60	29	2	0245 9500 050
DCS SVE DN 80	75/80	103.5	65.5	32	2	0245 9500 080
DCS SVE DN 100	100	134	82	39.5	3	0245 9500 100
DCS SVE DN 125	125	161	103	50	3	0245 9500 125
DCS SVE DN 150	150	186	103	50	3	0245 9500 150
DCS SVE DN 200	200	238	114	55.5	3	0245 9500 200



- 1 Hexagonal socket bolts
- 2 Hollow locking bars
- 3 Housing
- 4 Grip ring insert

The claw which resists high tensile loads

Combined with either DCS RAPID, DCS RAPID MSM or DCS CV/CE standards collars, our NORMACONNECT® DCS Universal Claw is an axial restraint claw which resists high tensile loads. The grip-type coupling resists high tensile loads for non-pull-out resistant connections.



Materials

W1	W2	W3	W4	W5
	x			

- W2**
- Material, Housing: AISI 430 Ti
 - Material, Closure unit: Steel, surface protected
 - Material, Grip ring: AISI 301

Information

- Recommended for use in combination with types RAPID/RAPID MSM: up to max. 10 bar
- Recommended for use in combination with types CV/CE: up to max. 5 bar (DN 50 – DN 200); up to max. 3 bar (DN 250 – DN 300)

Technical data & Ordering information

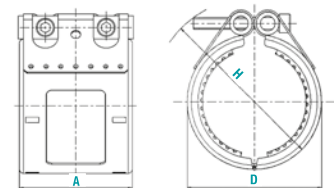

NORMACONNECT® DCS UNIVERSAL CLAW										
Designation	DN	A (mm)	D (mm)	H (mm)	Bolt (mm)	P max (bar)		Torque (Nm)	W2 Product No.	
						RAPID / RAPID MSM	CV/CE			
UNIVERSAL CLAW DN 50	50	77	85	105	M 8	10	5	Tight-Locking	0262 8401 050	
UNIVERSAL CLAW DN 70	70	77	100	120	M 8	10	5	Tight-Locking	0262 8402 070	
UNIVERSAL CLAW DN 75	75									
UNIVERSAL CLAW DN 80	75/80	77	105	125	M 8	10	5	Tight-Locking	0262 8403 080	
UNIVERSAL CLAW DN 100	100	97	130	150	M 10	10	5	Tight-Locking	0262 8405 100	
UNIVERSAL CLAW DN 125	125	97	165	195	M 10	10	5	Tight-Locking	0262 8406 125	
UNIVERSAL CLAW DN 150	150	97	185	215	M 10	5	5	Tight-Locking	0262 8407 150	
UNIVERSAL CLAW DN 200	200	113	240	270	M 12	5	5	Tight-Locking	0262 8415 200	
UNIVERSAL CLAW DN 250	250	139	305	335	M 12	3	3	Tight-Locking	0262 8416 250	
UNIVERSAL CLAW DN 300	300	139	400	490	M 12	3	3	Tight-Locking	0262 8417 300	



- 1 Hexagonal socket bolt with fine pitch thread
- 2 Guiding plate
- 3 Threaded plate
- 4 Housing
- 5 Grip ring insert (hardened)

The powerful add-on claw

Axial restraint safety claw for use with pressurized pump lines in lifting systems as well as for rainwater sewage lines that are at risk of undergoing back pressures, but only in combination with the NORMACONNECT® DCS RAPID standard collar. The powerful add-on claw for non-pull-out resistant connections.

Materials

W1	W2	W3	W4	W5
x				

- W1**
- Material, Housing: Steel, surface protected
 - Material, Closure unit: Steel, surface protected

Advantages at a glance

- Two parts (halves) with hardened grip ring inserts
- Strong guiding plates with threaded holes plus four hexagonal socket bolts with fine pitch thread

Technical data & Ordering information

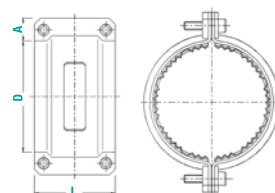

NORMACONNECT® DCS RECORD CLAW								
Designation	DN	A (mm)	D (mm)	L (mm)	Torque (Nm)	Bolt (mm)	P max (bar)	W1 Product No.
RECORD CLAW DN 40	40	21	65	66	12-15	M 8	up to 10	0262 1272 040
RECORD CLAW DN 50	50	21	75	69	12-15	M 8	up to 10	0262 1265 050
RECORD CLAW DN 70	70	21	95	69	12-15	M 8	up to 10	0262 1266 070
RECORD CLAW DN 80	75/80	21	100	69	12-15	M 8	up to 10	0262 1287 080
RECORD CLAW DN 100	100	25	135	87	25-30	M 10	up to 10	0262 1246 100
RECORD CLAW DN 125	125	25	160	95	30-35	M 10	up to 5	0262 1267 125
RECORD CLAW DN 150	150	25	185	95	30-35	M 10	up to 5	0262 1268 150
RECORD CLAW DN 200	200	30	235	111	60-65	M 12	up to 3	0262 1269 200

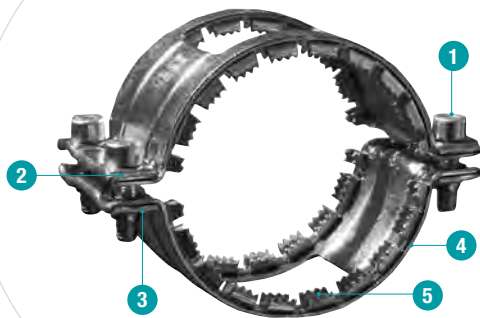

- 1 Hexagonal socket bolts
- 2 Guiding side
- 3 Threaded side
- 4 Housing
- 5 Grip ring insert

The powerful add-on claw

Our **NORMACONNECT®** DCS Combi Claw is an axial restraint safety claw for connecting rainwater and sewage lines that are at risk of undergoing back pressures. It is used in combination with **NORMACONNECT®** RAPID/RAPID MSM and **NORMACONNECT®** CV or CE standard collars. The powerful add-on claw for non-pull-out resistant connections.

Materials

W1	W2	W3	W4	W5
x				

- W1**
- Material, Housing: Steel, surface protected
 - Material, Closure unit: Steel, surface protected

Information

- Axial restraint up to 10 bar
- Diameters DN 50 up to DN 150

Technical data & Ordering information

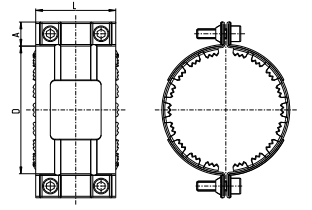

NORMACONNECT® DCS COMBI CLAW

Designation	DN	A (mm)	D (mm)	L (mm)	Torque (Nm)	Bolt (mm)	P max (bar)	W1 Product No.
COMBI CLAW DN 50	50	22	81	72	18-20	M 8	up to 10	0262 8590 050
COMBI CLAW DN 70	70	22	102	72	18-20	M 8	up to 10	0262 8590 070
COMBI CLAW DN 80	80	22	110	72	18-20	M 8	up to 10	0262 8590 080
COMBI CLAW DN 100	100	22	136	82	28-30	M 10	up to 10	0262 8591 100
COMBI CLAW DN 125	125	23.5	162	93	28-30	M 10	up to 5	0262 8592 125
COMBI CLAW DN 150	150	23.5	189	93	33-35	M 10	up to 5	0262 8592 150



- 1 Easy handling
- 2 Strong worm-drive hose clamp

The changeover connector with 2 lip seals

Materials

W1	W2	W3	W4	W5
	x			

- Material, Connector: EPDM
- Material, Worm-drive hose clamp band: AISI 430

Main advantage

The connection of feed or suction lines to a pipe – either made of steel or plastics – is easily and safely achieved with the CONFIX connector.

Technical data & Ordering information

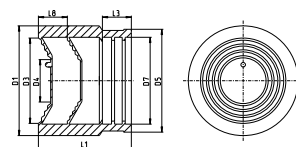

NORMACONNECT® DCS CONFIX, EPDM with TORRO W2, Changeover Connector

Designation	DN	D1 (mm)	D3 (mm)	D4 (mm)	D5 (mm)	D7 (mm)	L1 (mm)	L3 (mm)	L8 (mm)	W2 Product No.
CONFIX DN 50	50	72	56	30	67.5	57	63	19	19	0245 9003 050
CONFIX DN 70	70	92	75	41	86.5	77	77	19	24	0245 9003 070
CONFIX DN 80 56-75	80	92	75	41	91	81	77	19	24	0245 9003 075
CONFIX DN 80 75-90	80	108	90	58	93	81	88	19	23	0245 9003 080
CONFIX DN 100	100	128	110	78	118	108	95	21	23	0245 9003 100
CONFIX DN 125	125	145	126	90	145	132	103	21	27	0245 9003 125

Dimensions of pipes and fittings to EN 877

Dimensions of pipes and fittings to EN 877				
DN	Outside Diameter (OD)		Wall Thickness	
	Nominal value	Tolerances	Nominal value	Minimum value
40	48	+2 -1	3.0	2.5
50	58	+2 -1	3.5	3.0
70	78	+2 -1	3.5	3.0
75/80	83	+2 -1	3.5	3.0
100	110	+2 -1	3.5	3.0
125	135	+2 -2	4.0	3.5
150	160	+2 -2	4.0	3.5
200	210	+2.5 -2.5	5.0	4.0
250	274	+2.5 -2.5	5.5	4.5
300	326	+2.5 -2.5	6.0	5.0
400	429	+2 -3	6.3	5.0
500	532	+2 -3.5	7.0	5.2
600	635	+2 -4	7.7	5.8

Dimensions in mm

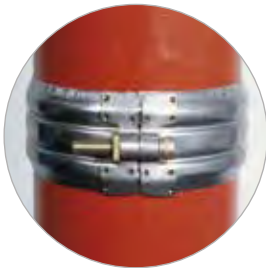



- 1 Male threaded adaptor -MA
- 2 Straight coupler - SC
- 3 Female threaded adaptor - FA
- 4 Flange adaptor - FLA
- 5 Equal bend -EB
- 6 Male threaded elbow - MB
- 7 Female threaded elbow - FB
- 8 Male threaded tee - MT
- 9 Female threaded tee - FT

PN 16 for non-potable water

NORMA® Compression fittings are made of polypropylene for high-and-low density polyethylene tubing, diameters 16 to 110. Maximum service pressure: PN 16* bar from diameter 16 to diameter 63 – PN 12.5 bar from diameter 75 to diameter 110. DOES NOT INCLUDE hot water application. NORMA® products are made in factories certified under ISO 9001 Version 2008. NORMA® fittings are tested and approved according to these standards: ISO 14236 (Czech Republic). ITC (Poland): BS Standard 5114, AS / NZ 4129, AS 4020. These products are not certified as compliant with international sanitary regulations for transport of potable water and liquid foods.

*PN 10 version available in our water management catalogue



Advantages at a glance

- Safe and durable
- Fast and easily connected
- Perfect water tightness
- Locking nut for a clinching system
- Simple insertion of the tube in the fitting
- No special workforce required
- High resistance to temperature and ultraviolet shocks

Applications

- Watering: Residential, municipal, sport fields, golf courses.
- Irrigation: Agriculture, horticulture, vineyards.
- Industry: Compressed air.

Information

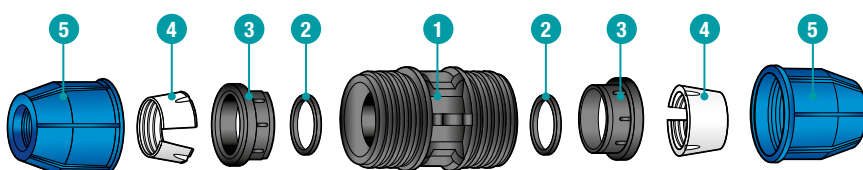

- 1 Body of Polypropylene
- 2 O-ring of NBR
- 3 Holder of Polypropylene
- 4 Clinching Ring of POM, acetal
- 5 Locking nut of Polypropylene

Male threaded adaptor – MA



NORMACONNECT®

Size mm x inch	Designation	Polypropylene homopolymer Product No.
16 x 1/2"	MALE THREADED ADAPTOR (MA) 16 x 1/2"	0796 2601 111
16 x 3/4"	MALE THREADED ADAPTOR (MA) 16 x 3/4"	0796 2601 112
20 x 1/2"	MALE THREADED ADAPTOR (MA) 20 x 1/2"	0796 2651 118
20 x 3/4"	MALE THREADED ADAPTOR (MA) 20 x 3/4"	0796 2651 120
20 x 1"	MALE THREADED ADAPTOR (MA) 20 x 1"	0796 2651 117
25 x 1/2"	MALE THREADED ADAPTOR (MA) 25 x 1/2"	0796 2651 121
25 x 3/4"	MALE THREADED ADAPTOR (MA) 25 x 3/4"	0796 2651 122
25 x 1"	MALE THREADED ADAPTOR (MA) 25 x 1"	0796 2651 124
32 x 1/2"	MALE THREADED ADAPTOR (MA) 32 x 1/2"	0796 2651 126
32 x 3/4"	MALE THREADED ADAPTOR (MA) 32 x 3/4"	0796 2651 127
32 x 1"	MALE THREADED ADAPTOR (MA) 32 x 1"	0796 2651 128
32 x 1 1/4"	MALE THREADED ADAPTOR (MA) 32 x 1 1/4"	0796 2651 130
40 x 3/4"	MALE THREADED ADAPTOR (MA) 40 x 3/4"	0796 2651 131
40 x 1"	MALE THREADED ADAPTOR (MA) 40 x 1"	0796 2651 132
40 x 1 1/4"	MALE THREADED ADAPTOR (MA) 40 x 1 1/4"	0796 2651 133
40 x 1 1/2"	MALE THREADED ADAPTOR (MA) 40 x 1 1/2"	0796 2651 134
50 x 1 1/4"	MALE THREADED ADAPTOR (MA) 50 x 1 1/4"	0796 2651 135
50 x 1 1/2"	MALE THREADED ADAPTOR (MA) 50 x 1 1/2"	0796 2651 136
50 x 2"	MALE THREADED ADAPTOR (MA) 50 x 2"	0796 2651 137
63 x 1 1/2"	MALE THREADED ADAPTOR (MA) 63 x 1 1/2"	0796 2651 138
63 x 2"	MALE THREADED ADAPTOR (MA) 63 x 2"	0796 2651 139
75 x 2"	MALE THREADED ADAPTOR (MA) 75 x 2"	0796 2640 310
75 x 2 1/2"	MALE THREADED ADAPTOR (MA) 75 x 2 1/2"	0796 2640 311
90 x 3"	MALE THREADED ADAPTOR (MA) 90 x 3"	0796 2640 312
110 x 4"	MALE THREADED ADAPTOR (MA) 110 x 4"	0796 2640 313

Female threaded adaptor – FA



Size mm x inch	Designation	Polypropylene homopolymer Product No.
16 x 1/2"	FEMALE THREADED ADAPTOR (FA) 16 x 1/2"	0796 2602 111
16 x 3/4"	FEMALE THREADED ADAPTOR (FA) 16 x 3/4"	0796 2602 112
20 x 1/2"	FEMALE THREADED ADAPTOR (FA) 20 x 1/2"	0796 2651 018
20 x 3/4"	FEMALE THREADED ADAPTOR (FA) 20 x 3/4"	0796 2651 020
25 x 1/2"	FEMALE THREADED ADAPTOR (FA) 25 x 1/2"	0796 2651 022
25 x 3/4"	FEMALE THREADED ADAPTOR (FA) 25 x 3/4"	0796 2651 025
25 x 1"	FEMALE THREADED ADAPTOR (FA) 25 x 1"	0796 2651 028
32 x 3/4"	FEMALE THREADED ADAPTOR (FA) 32 x 3/4"	0796 2651 030
32 x 1"	FEMALE THREADED ADAPTOR (FA) 32 x 1"	0796 2651 033
32 x 1 1/4"	FEMALE THREADED ADAPTOR (FA) 32 x 1 1/4"	0796 2651 035
40 x 1"	FEMALE THREADED ADAPTOR (FA) 40 x 1"	0796 2651 037
40 x 1 1/4"	FEMALE THREADED ADAPTOR (FA) 40 x 1 1/4"	0796 2651 039
40 x 1 1/2"	FEMALE THREADED ADAPTOR (FA) 40 x 1 1/2"	0796 2651 041
50 x 1 1/2"	FEMALE THREADED ADAPTOR (FA) 50 x 1 1/2"	0796 2651 043
50 x 2"	FEMALE THREADED ADAPTOR (FA) 50 x 2"	0796 2651 045
63 x 1 1/2"	FEMALE THREADED ADAPTOR (FA) 63 x 1 1/2"	0796 2651 047
63 x 2"	FEMALE THREADED ADAPTOR (FA) 63 x 2"	0796 2651 049
75 x 2"	FEMALE THREADED ADAPTOR (FA) 75 x 2"	0796 2640 291
75 x 2 1/2"	FEMALE THREADED ADAPTOR (FA) 75 x 2 1/2"	0796 2640 293
90 x 3"	FEMALE THREADED ADAPTOR (FA) 90 x 3"	0796 2640 295
110 x 4"	FEMALE THREADED ADAPTOR (FA) 110 x 4"	0796 2640 297

Male threaded tee – MT



Size mm x inch	Designation	Polypropylene homopolymer Product No.
16 x 1/2"	MALE THREADED TEE (MT) 16 x 1/2"	0796 2603 111
16 x 3/4"	MALE THREADED TEE (MT) 16 x 3/4"	0796 2603 112
20 x 1/2"	MALE THREADED TEE (MT) 20 x 1/2"	0796 2651 154
20 x 3/4"	MALE THREADED TEE (MT) 20 x 3/4"	0796 2651 155
25 x 1/2"	MALE THREADED TEE (MT) 25 x 1/2"	0796 2651 156
25 x 3/4"	MALE THREADED TEE (MT) 25 x 3/4"	0796 2651 157
25 x 1"	MALE THREADED TEE (MT) 25 x 1"	0796 2651 158
32 x 3/4"	MALE THREADED TEE (MT) 32 x 3/4"	0796 2651 159
32 x 1"	MALE THREADED TEE (MT) 32 x 1"	0796 2651 160
40 x 1"	MALE THREADED TEE (MT) 40 x 1"	0796 2651 161
40 x 1 1/4"	MALE THREADED TEE (MT) 40 x 1 1/4"	0796 2651 162
50 x 1 1/4"	MALE THREADED TEE (MT) 50 x 1 1/4"	0796 2651 163
50 x 1 1/2"	MALE THREADED TEE (MT) 50 x 1 1/2"	0796 2651 164
63 x 2"	MALE THREADED TEE (MT) 63 x 2"	0796 2651 165
75 x 2"	MALE THREADED TEE (MT) 75 x 2"	0796 2640 318
75 x 2 1/2"	MALE THREADED TEE (MT) 75 x 2 1/2"	0796 2640 319
90 x 3"	MALE THREADED TEE (MT) 90 x 3"	0796 2640 320
110 x 4"	MALE THREADED TEE (MT) 110 x 4"	0796 2640 321

NORMACONNECT®

Female threaded tee – FT



Size mm x inch	Designation	Polypropylene homopolymer Product No.
16 x 1/2"	FEMALE THREADED TEE (FT) 16 x 1/2"	0796 2604 111
16 x 3/4"	FEMALE THREADED TEE (FT) 16 x 3/4"	0796 2604 112
20 x 1/2"	FEMALE THREADED TEE (FT) 20 x 1/2"	0796 2651 088
20 x 3/4"	FEMALE THREADED TEE (FT) 20 x 3/4"	0796 2651 090
25 x 1/2"	FEMALE THREADED TEE (FT) 25 x 1/2"	0796 2651 092
25 x 3/4"	FEMALE THREADED TEE (FT) 25 x 3/4"	0796 2651 094
25 x 1"	FEMALE THREADED TEE (FT) 25 x 1"	0796 2651 096
32 x 3/4"	FEMALE THREADED TEE (FT) 32 x 3/4"	0796 2651 098
32 x 1"	FEMALE THREADED TEE (FT) 32 x 1"	0796 2651 100
32 x 1 1/4"	FEMALE THREADED TEE (FT) 32 x 1 1/4"	0796 2651 102
40 x 1"	FEMALE THREADED TEE (FT) 40 x 1"	0796 2651 104
40 x 1 1/4"	FEMALE THREADED TEE (FT) 40 x 1 1/4"	0796 2651 106
40 x 1 1/2"	FEMALE THREADED TEE (FT) 40 x 1 1/2"	0796 2651 108
50 x 1 1/2"	FEMALE THREADED TEE (FT) 50 x 1 1/2"	0796 2651 110
50 x 2"	FEMALE THREADED TEE (FT) 50 x 2"	0796 2651 112
63 x 1 1/2"	FEMALE THREADED TEE (FT) 63 x 1 1/2"	0796 2651 114
63 x 2"	FEMALE THREADED TEE (FT) 63 x 2"	0796 2651 116
75 x 2 1/2"	FEMALE THREADED TEE (FT) 75 x 2 1/2"	0796 2640 305
90 x 3"	FEMALE THREADED TEE (FT) 90 x 3"	0796 2640 307
110 x 4"	FEMALE THREADED TEE (FT) 110 x 4"	0796 2640 309

Male threaded elbow – MB



NORMACONNECT®

Size mm x inch	Designation	Polypropylene homopolymer Product No.
16 x 1/2"	MALE THREADED ELBOW (MB) 16 x 1/2"	0796 2605 111
16 x 3/4"	MALE THREADED ELBOW (MB) 16 x 3/4"	0796 2605 112
20 x 1/2"	MALE THREADED ELBOW - MALE BEND 90 (MB) 20 x 1/2"	0796 2651 140
20 x 3/4"	MALE THREADED ELBOW - MALE BEND 90 (MB) 20 x 3/4"	0796 2651 141
25 x 1/2"	MALE THREADED ELBOW - MALE BEND 90 (MB) 25 x 1/2"	0796 2651 142
25 x 3/4"	MALE THREADED ELBOW - MALE BEND 90 (MB) 25 x 3/4"	0796 2651 143
25 x 1"	MALE THREADED ELBOW - MALE BEND 90 (MB) 25 x 1"	0796 2651 144
32 x 3/4"	MALE THREADED ELBOW - MALE BEND 90 (MB) 32 x 3/4"	0796 2651 145
32 x 1"	MALE THREADED ELBOW - MALE BEND 90 (MB) 32 x 1"	0796 2651 146
40 x 1"	MALE THREADED ELBOW - MALE BEND 90 (MB) 40 x 1"	0796 2651 147
40 x 1 1/4"	MALE THREADED ELBOW - MALE BEND 90 (MB) 40 x 1 1/4"	0796 2651 148
40 x 1 1/2"	MALE THREADED ELBOW - MALE BEND 90 (MB) 40 x 1 1/2"	0796 2651 149
50 x 1 1/4"	MALE THREADED ELBOW - MALE BEND 90 (MB) 50 x 1 1/4"	0796 2651 150
50 x 1 1/2"	MALE THREADED ELBOW - MALE BEND 90 (MB) 50 x 1 1/2"	0796 2651 151
50 x 2"	MALE THREADED ELBOW - MALE BEND 90 (MB) 63 x 2"	0796 2651 152
63 x 2"	MALE THREADED ELBOW - MALE BEND 90 (MB) 63 x 2"	0796 2651 153
75 x 2"	MALE THREADED ELBOW - MALE BEND 90 (MB) 75 x 2"	0796 2640 314
75 x 2 1/2"	MALE THREADED ELBOW - MALE BEND 90 (MB) 75 x 2 1/2"	0796 2640 315
90 x 3"	MALE THREADED ELBOW - MALE BEND 90 (MB) 90 x 3"	0796 2640 316
110 x 4"	MALE THREADED ELBOW - MALE BEND 90 (MB) 110 x 4"	0796 2640 317

Female threaded elbow – FB



Size mm x inch	Designation	Polypropylene homopolymer Product No.
16 x 1/2"	FEMALE THREADED ELBOW (FB) 16 x 1/2"	0796 2606 111
16 x 3/4"	FEMALE THREADED ELBOW (FB) 16 x 3/4"	0796 2606 112
20 x 1/2"	FEMALE THREADED ELBOW - FEMALE BEND 90 (FB) 20 x 1/2"	0796 2651 051
20 x 3/4"	FEMALE THREADED ELBOW - FEMALE BEND 90 (FB) 20 x 3/4"	0796 2651 054
25 x 1/2"	FEMALE THREADED ELBOW - FEMALE BEND 90 (FB) 25 x 1/2"	0796 2651 056
25 x 3/4"	FEMALE THREADED ELBOW - FEMALE BEND 90 (FB) 25 x 3/4"	0796 2651 059
25 x 1"	FEMALE THREADED ELBOW - FEMALE BEND 90 (FB) 25 x 1"	0796 2651 061
32 x 1/2"	FEMALE THREADED ELBOW - FEMALE BEND 90 (FB) 32 x 1/2"	0796 2651 063
32 x 3/4"	FEMALE THREADED ELBOW - FEMALE BEND 90 (FB) 32 x 3/4"	0796 2651 065
32 x 1"	FEMALE THREADED ELBOW - FEMALE BEND 90 (FB) 32 x 1"	0796 2651 068
32 x 1 1/4"	FEMALE THREADED ELBOW - FEMALE BEND 90 (FB) 32 x 1 1/4"	0796 2651 070
40 x 1"	FEMALE THREADED ELBOW - FEMALE BEND 90 (FB) 40 x 1"	0796 2651 072
40 x 1 1/4"	FEMALE THREADED ELBOW - FEMALE BEND 90 (FB) 40 x 1 1/4"	0796 2651 074
40 x 1 1/2"	FEMALE THREADED ELBOW - FEMALE BEND 90 (FB) 40 x 1 1/2"	0796 2651 076
50 x 1 1/4"	FEMALE THREADED ELBOW - FEMALE BEND 90 (FB) 50 x 1 1/4"	0796 2651 078
50 x 1 1/2"	FEMALE THREADED ELBOW - FEMALE BEND 90 (FB) 50 x 1 1/2"	0796 2651 080
50 x 2"	FEMALE THREADED ELBOW - FEMALE BEND 90 (FB) 50 x 2"	0796 2651 082
63 x 1 1/2"	FEMALE THREADED ELBOW - FEMALE BEND 90 (FB) 63 x 1 1/2"	0796 2651 084
63 x 2"	FEMALE THREADED ELBOW - FEMALE BEND 90 (FB) 63 x 2"	0796 2651 086
75 x 2 1/2"	FEMALE THREADED ELBOW - FEMALE BEND 90 (FB) 75 x 2 1/2"	0796 2640 299
90 x 3"	FEMALE THREADED ELBOW - FEMALE BEND 90 (FB) 90 x 3"	0796 2640 301
110 x 4"	FEMALE THREADED ELBOW - FEMALE BEND 90 (FB) 110 x 4"	0796 2640 303

Straight coupler – SC



Size mm x inch	Designation	Polypropylene homopolymer Product No.
16"	STRAIGHT COUPLER (SC) 16	0796 2607 111
20"	STRAIGHT COUPLER (SC) 20	0796 2651 191
25"	STRAIGHT COUPLER (SC) 25	0796 2651 192
32"	STRAIGHT COUPLER (SC) 32	0796 2651 193
40"	STRAIGHT COUPLER (SC) 40	0796 2651 194
50"	STRAIGHT COUPLER (SC) 50	0796 2651 195
63"	STRAIGHT COUPLER (SC) 63	0796 2651 196
75"	STRAIGHT COUPLER (SC) 75	0796 2640 334
90"	STRAIGHT COUPLER (SC) 90	0796 2640 335
110"	STRAIGHT COUPLER (SC) 110	0796 2640 336

NORMACONNECT®

Equal bend – EB



Size mm x inch	Designation	Polypropylene homopolymer Product No.
16	EQUAL BEND (EB) 16	0796 2608 111
20	EQUAL BEND (EB) 20	0796 2650 998
25	EQUAL BEND (EB) 25	0796 2650 999
32	EQUAL BEND (EB) 32	0796 2651 000
40	EQUAL BEND (EB) 40	0796 2651 001
50	EQUAL BEND (EB) 50	0796 2651 002
63	EQUAL BEND (EB) 63	0796 2651 003
75	EQUAL BEND (EB) 75	0796 2640 281
90	EQUAL BEND (EB) 90	0796 2640 282
110	EQUAL BEND (EB) 110	0796 2640 283

Equal tee – ET



Size mm x inch	Designation	Polypropylene homopolymer Product No.
16	EQUAL TEE (ET) 16	0796 2609 111
20	EQUAL TEE (ET) 20	0796 2651 010
25	EQUAL TEE (ET) 25	0796 2651 011
32	EQUAL TEE (ET) 32	0796 2651 012
40	EQUAL TEE (ET) 40	0796 2651 013
50	EQUAL TEE (ET) 50	0796 2651 014
63	EQUAL TEE (ET) 63	0796 2651 015
75	EQUAL TEE (ET) 75	0796 2640 287
90	EQUAL TEE (ET) 90	0796 2640 288
110	EQUAL TEE (ET) 110	0796 2640 289

End cap – EC



Size mm x inch	Designation	Polypropylene homopolymer Product No.
16	END CAP (EC) 16	0796 2610 111
20	END CAP (EC) 20	0796 2651 004
25	END CAP (EC) 25	0796 2651 005
32	END CAP (EC) 32	0796 2651 006
40	END CAP (EC) 40	0796 2651 007
50	END CAP (EC) 50	0796 2651 008
63	END CAP (EC) 63	0796 2651 009
75	END CAP (EC) 75	0796 2640 284
90	END CAP (EC) 90	0796 2640 285
110	END CAP (EC) 110	0796 2640 286

Reducing coupler – RC



Size mm x inch	Designation	Polypropylene homopolymer Product No.
25 x 20"	REDUCING COUPLER (RC) 25 x 20"	0796 2651 166
32 x 20"	REDUCING COUPLER (RC) 32 x 20"	0796 2651 167
32 x 25"	REDUCING COUPLER (RC) 32 x 25"	0796 2651 168
40 x 20"	REDUCING COUPLER (RC) 40 x 20"	0796 2651 169
40 x 25"	REDUCING COUPLER (RC) 40 x 25"	0796 2651 170
40 x 32"	REDUCING COUPLER (RC) 40 x 32"	0796 2651 171
50 x 20"	REDUCING COUPLER (RC) 50 x 20"	0796 2651 172
50 x 25"	REDUCING COUPLER (RC) 50 x 25"	0796 2651 173
50 x 32"	REDUCING COUPLER (RC) 50 x 32"	0796 2651 174
50 x 40"	REDUCING COUPLER (RC) 50 x 40"	0796 2651 175
63 x 25"	REDUCING COUPLER (RC) 63 x 25"	0796 2651 176
63 x 32"	REDUCING COUPLER (RC) 63 x 32"	0796 2651 177
63 x 40"	REDUCING COUPLER (RC) 63 x 40"	0796 2651 178
63 x 50"	REDUCING COUPLER (RC) 63 x 50"	0796 2651 179
75 x 40"	REDUCING COUPLER (RC) 75 x 40"	0796 2640 322
75 x 50"	REDUCING COUPLER (RC) 75 x 50"	0796 2640 323
75 x 63"	REDUCING COUPLER (RC) 75 x 63"	0796 2640 324
90 x 63"	REDUCING COUPLER (RC) 90 x 63"	0796 2640 325
90 x 75"	REDUCING COUPLER (RC) 90 x 75"	0796 2640 326
110 x 90"	REDUCING COUPLER (RC) 110 x 90"	0796 2640 327

Reducing tee – RT



Size mm x inch	Designation	Polypropylene homopolymer Product No.
25 x 20"	REDUCING TEE (RT) 25 x 20"	0796 2651 180
32 x 20"	REDUCING TEE (RT) 32 x 20"	0796 2651 181
32 x 25"	REDUCING TEE (RT) 32 x 25"	0796 2651 182
40 x 25"	REDUCING TEE (RT) 40 x 25"	0796 2651 183
40 x 32"	REDUCING TEE (RT) 40 x 32"	0796 2651 184
50 x 25"	REDUCING TEE (RT) 50 x 25"	0796 2651 185
50 x 32"	REDUCING TEE (RT) 50 x 32"	0796 2651 186
50 x 40"	REDUCING TEE (RT) 50 x 40"	0796 2651 187
63 x 32"	REDUCING TEE (RT) 63 x 32"	0796 2651 188
63 x 40"	REDUCING TEE (RT) 63 x 40"	0796 2651 189
63 x 50"	REDUCING TEE (RT) 63 x 50"	0796 2651 190
75 x 40"	REDUCING TEE (RT) 75 x 40"	0796 2640 328
75 x 50"	REDUCING TEE (RT) 75 x 50"	0796 2640 329
75 x 63"	REDUCING TEE (RT) 75 x 63"	0796 2640 330
90 x 63"	REDUCING TEE (RT) 90 x 63"	0796 2640 331
90 x 75"	REDUCING TEE (RT) 90 x 75"	0796 2640 332
110 x 90"	REDUCING TEE (RT) 110 x 90"	0796 2640 333

Flange adaptor – FLA



Size mm x inch	Designation	Polypropylene homopolymer Product No.
63 x 50DN	FLANGE ADAPTOR (FLA) 63 x 50DN	0796 2600 004
90 x 80DN	FLANGE ADAPTOR (FLA) 90 x 80DN	0796 2600 005
110 x 100DN	FLANGE ADAPTOR (FLA) 110 x 100DN	0796 2600 006

Pop-up Equal bend – PE



Size mm x inch	Designation	Polypropylene homopolymer Product No.
20 x 1/2"	POP-UP EQUAL BEND (PE) 20 x 1/2"	0796 2030 181
25 x 1/2"	POP-UP EQUAL BEND (PE) 25 x 1/2"	0796 2030 182
32 x 3/4"	POP-UP EQUAL BEND (PE) 32 x 3/4"	0796 2030 183

Wall plate elbow – WPE



Size mm x inch	Designation	Polypropylene homopolymer Product No.
25 x 3/4"	WALL PLATE ELBOW (WPE) 25 x 3/4"	0796 2030 360

**Male threaded adaptor with
brass insert – MAB**



Size mm x inch	Designation	Polypropylene homopolymer Product No.
20 x 1/2"	MALE THREADED ADAPTOR WITH BRASS INSERT (MAB) 20 x 1/2"	0796 2651 119
25 x 3/4"	MALE THREADED ADAPTOR WITH BRASS INSERT (MAB) 25 x 3/4"	0796 2651 123
25 x 1"	MALE THREADED ADAPTOR WITH BRASS INSERT (MAB) 25 x 1"	0796 2651 125
32 x 1"	MALE THREADED ADAPTOR WITH BRASS INSERT (MAB) 32 x 1"	0796 2651 129

**Female threaded adaptor with
brass insert – FAB**



Size mm x inch	Designation	Polypropylene homopolymer Product No.
20 x 1/2"	FEMALE THREADED ADAPTOR WITH BRASS INSERT (FAB) 20 x 1/2"	0796 2651 017
25 x 3/4"	FEMALE THREADED ADAPTOR WITH BRASS INSERT (FAB) 25 x 3/4"	0796 2651 024
25 x 1"	FEMALE THREADED ADAPTOR WITH BRASS INSERT (FAB) 25 x 1"	0796 2651 027
32 x 1"	FEMALE THREADED ADAPTOR WITH BRASS INSERT (FAB) 32 x 1"	0796 2651 032

**Female threaded bend with
brass insert – FBB**



Size mm x inch	Designation	Polypropylene homopolymer Product No.
20 x 3/4"	FEMALE THREADED BEND WITH BRASS INSERT (FBB) 20 x 3/4"	0796 2651 053
25 x 3/4"	FEMALE THREADED BEND WITH BRASS INSERT (FBB) 25 x 3/4"	0796 2651 058
32 x 1"	FEMALE THREADED BEND WITH BRASS INSERT (FBB) 32 x 1"	0796 2651 067



- 1 Torx screw with integrated washer**
– makes installation and removal easier
- 2 Band adapted to fit ball-shaped flange connections**
– system works in perfect harmony
- 3 Free from chromium(VI); easy-slide coating**
– improved clamping force
- 4 Solid trunnion, chromium(VI)-free coating**
– high temperature resistance, maintains high clamping force levels

Ball zone exhaust gas clamps

NORMACONNECT® SEC ball zone exhaust gas clamps are the ideal solution when it comes to making connections in central and rear exhaust gas areas. When used in conjunction with flange joints, it is possible to swivel silencers during installation.

Advantages at a glance

- Angle compensation in exhaust gas system
- Silencers can be swiveled during installation
- Installation and removal conditions easier to work with thanks to increased flexibility of overall system
- Higher torsion moments than conventional ball-shaped flange connections
- Low leakage rate
- Low weight

Applications

- For low leak joints in rear and centre sections of car and truck exhaust systems with operating clamp surface temperatures of up to 700 °C.

Materials

W1	W2	W3	W4	W5
	x			

Material	Corrosion resistance in salt spray testing
W2	Min. 96 h

Technical data & Ordering information

NORMACONNECT® SEC					
Designation	Pipe diameter Inner		Clamping diameter in mm	Flange radius in mm	W2 Product No.
	in mm	in inches			
SEC 55	55	2 3/16"	65	32.5	0595 6312 055-1
SEC 60	60	2 3/8"	69.5	34.8	0595 5312 060-1
SEC 65	65	2 9/16"	75	37.6	0595 5312 065-1
SEC 70	70	2 3/4"	81.5	40.2	0595 6312 070-1
SEC 75	75	2 20/21"	87	42.5	0595 6342 075

Additional diameters on request



- 1 M8, M10 & M12 bolts available as alternatives**
– depending on clamping force requirements
- 2 Clamp band in one piece**
– contact surface meets pipe consistently
– even contact pressure over the entire pipe circumference
– excellent sealing properties
- 3 Single-bolt closure**
– easy installation
- 4 Rounded band edges**
– pipe protection
– prevents risk of injuries

Exhaust pipe clamps

NORMACONNECT®ARS exhaust pipe clamps provide a secure, reliable connection for pipes that are fitted into one another, even those that are subject to significant temperature fluctuations. As such, they are particularly suitable for connecting exhaust pipes and silencers in the automotive industry.



Advantages at a glance

- One piece
- Contact surface meets pipe consistently
- Even contact pressure over entire pipe circumference
- No risk of asymmetrical pipe deformation

Applications

- Agricultural machines
- Building machines
- Engine manufacturing

Materials

W1	W2	W3	W4	W5
x	x*		x*	x*

* On request.

Material	Corrosion resistance in salt spray testing
W1	Min. 144 h

Bolts

Bolt	Hammer head bolt/Flange nut	Hexagon-head bolt/Flange nut	Hexagon-head bolt/Hexagon	Loose washer *
M8	X	X		X **
M10			X	X
M12			X	X

* Under bolt head and under bolt nut.

** Under bolt head (select nominal diameters only).



M8 version with hammer head bolt.

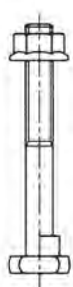

M10 and M12 version with hexagon-head bolt.



Technical data & Ordering information

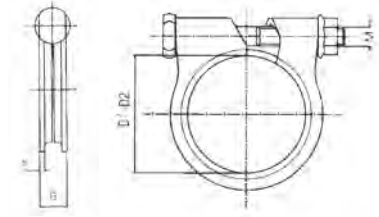

NORMACONNECT® ARS					
Designation	Clamping ranges D1–D2 in mm	S	B	Recommended tightening torque	W1 Product No.
ARS-M8-27	24-27	1.5	10.4	8–10 Nm	0151 8939 027
ARS-M8-33	30-33	1.5	10.4		0151 8939 033
ARS-M8-36	33-36	2.0	12.8	10–15 Nm	0151 8940 036
ARS-M8-39.5	36.5-39.5	2.0	12.0		0151 8940 040
ARS-M8-42	39-42	2.0	12.8		0151 8940 042
ARS-M8-45	42-45	2.5	13.6		0151 8941 045
ARS-M8-46	43-46	2.5	12.8		0151 8941 046
ARS-M8-47	44-47	2.5	13.6	15-20 Nm	0151 8941 047
ARS-M8-48	45-49	2.5	13.2		0151 8941 048
ARS-M8-49	45-49	2.5	13.2		0151 8941 049
ARS-M8-50.5	51-54	2.5	13.2		0151 8941 505
ARS-M8-51	48-51	2.5	13.2		0151 8941 051
ARS-M8-54	51-54	2.5	13.2		0151 8941 054
ARS-M8-55	52-55	2.5	13.6		0151 8941 055
ARS-M8-58	55-58	2.5	13.2		0151 8941 058
ARS-M8-64	61-64	2.5	13.2		0151 8941 064
ARS-M8-66	63-66	2.5	13.2		0151 8941 066
ARS-M8-71	68-71	2.5	13.2	0151 8941 071	
ARS-M10-71	67-71.5	3.0	13.2	35-40 Nm	0161 8939 071
ARS-M10-94	90-94	3.0	19.0		0181 8939 094
ARS-M10-107	102-107	3.0	19.0		0181 8941 107
ARS-M12-114	106-114	3.0	19.0		0181 8079 114
ARS-M12-133	129-133	3.0	19.0		0181 8079 133
ARS-M12-145	137.5-144.5	3.0	19.0		0181 8941 145



- 1 Option of attaching a lug**
– clamp can also function as a fixing clip or retaining clamp
- 2 Clamp supplied without bolts**
– bolts can be selected individually
- 3 Straightforward clamp structure**
– pipe protection
– easy to handle

Exhaust pipe clamps in accordance with DIN 71555

NORMACONNECT® RS/DIN exhaust pipe clamps are an alternative to NORMACONNECT® ARS clamps. They ensure an equally secure connection for pipes that are fitted into one another. Additionally, the straightforward clamp structure of the RS/DIN version allows a lug to be attached to it, meaning that it can also be used as a fixing clip.



Advantages at a glance

- Safe system for connecting pipes that are fitted to one another
- Can also be used as a fixing clip or retaining clamp
- In accordance with DIN 71555

Applications

- Agricultural machines
- Building machines
- Engine manufacturing

Materials

W1	W2	W3	W4	W5
x		x *	x *	x *

* On request.

Material	Corrosion resistance in salt spray testing
W1	Min. 144 h

Bolts

The scope of delivery does not include fastening bolts or nuts. Sizes M8 or M10 are required.

Technical data & Ordering information

NORMACONNECT® RS/DIN				
Band width	Designation	Clamping diameter in mm	W1 Product No.	
20	RS 30.2 DIN 71555	30.2	0550 7000 030	
	RS 32.2 DIN 71555	32.2	0550 7000 032	
	RS 35.2 DIN 71555	35.2	0550 7000 035	
	RS 37.2 DIN 71555	37.2	0550 7000 037	
25	RS 40.3 DIN 71555	40.3	0550 7000 040	
	RS 42.3 DIN 71555	42.3	0550 7000 042	
	RS 45.5 DIN 71555	45.5	0550 7000 045	
	RS 48.5 DIN 71555	48.5	0550 7000 048	
	RS 50.5 DIN 71555	50.5	0550 7000 050	
	RS 53.5 DIN 71555	53.5	0550 7000 053	
	RS 55.5 DIN 71555	55.5	0550 7000 055	
	RS 58.5 DIN 71555	58.5	0550 7000 058	
	RS 60.5 DIN 71555	60.5	0550 7000 060	
	RS 63.5 DIN 71555	63.5	0550 7000 063	
	RS 65.5 DIN 71555	65.5	0550 7000 065	
	RS 68.5 DIN 71555	68.5	0550 7000 068	
	30	RS 70.5 DIN 71555	70.5	0550 7000 070
		RS 73.5 DIN 71555	73.5	0550 7000 073
RS 75.5 DIN 71555		75.5	0550 7000 075	
RS 78.5 DIN 71555		78.5	0550 7000 078	
RS 85.5 DIN 71555		85.5	0550 7000 085	
RS 89.5 DIN 71555		89.5	0550 7000 089	
RS 90.5 DIN 71555		90.5	0550 7000 090	
RS 94.5 DIN 71555		94.5	0550 7000 094	
RS 100.5 DIN 71555		100.5	0550 7000 100	
RS 104.5 DIN 71555		104.5	0550 7000 104	
RS 110.5 DIN 71555		110.5	0550 7000 110	



- 1 High-strength fastener hardware with corrosion-resistant coating on semi-finished parts
- 2 Easy to assemble
- 3 Reaction block serves as a defined stop, avoiding pipe deformation

Unique seal clamp

The NORMACONNECT® AccuSeal offers an innovative reaction block technology to provide a full 360 degree equal distribution of clamping force, prohibiting pipe distortion while completing a unique seal around the joined exhaust components with high clamp load. The exhaust connections are serviceable and easy to disassemble.



Advantages at a glance

- Simple, effective way to connect exhaust system components
- Unique seal and high clamp loads are provided without permanent distortion to exhaust members
- Provides joint serviceability
- Durable installation without damage to pipe ends
- Designed for part-in-assembly attachment
- Superior clamp load capability

Applications

- For connecting exhaust system components
- Assembled, serviceable joint for use on all slotted rigid pipe
- Pipes, mufflers and converters

Materials

W1	W2	W3	W4	W5
x		x		

W4 available as standard, on request

Information

Features 47.0 mm band up to 70.6 mm

Technical data & Ordering information

- 55 Nm ± 8 Nm tightening torque
- 600 °C skin temperature
- 950 °C gas temperature

Technical data & Ordering information

NORMACONNECT® ACCUSEAL			
Description	Diameter in mm	W1 Product No.	W3 Product No.
ACCUSEAL 47.0	47.0		0366 6100 470
ACCUSEAL 47.6	47.6		0366 6100 476
ACCUSEAL 50.0	50.0	0366 6100 500	0366 6120 500
ACCUSEAL 50.6	50.6	0366 6110 506	0366 6100 506
ACCUSEAL 52.0	52.0		0366 6100 520
ACCUSEAL 53.0	53.0		0366 6100 530
ACCUSEAL 53.6	53.6	0366 6120 536	0366 6110 536
ACCUSEAL 53.6	53.6		0366 6100 536
ACCUSEAL 54.9	54.9	0366 6120 549	0366 6100 549
ACCUSEAL 55.5	55.5		0366 6100 555
ACCUSEAL 55.6	55.6		0366 6130 556
ACCUSEAL 55.7	55.7		0366 6110 557
ACCUSEAL 56.0	56.0	0366 6100 560	
ACCUSEAL 56.4	56.4	0366 6100 564	0366 6110 564
ACCUSEAL 57.6	57.6		0366 6110 576
ACCUSEAL 58.7	58.7		0366 6110 587
ACCUSEAL 59.2	59.2		0366 6000 592
ACCUSEAL 59.4	59.4	0366 6110 594	0366 6120 594
ACCUSEAL 59.7	59.7		0366 6100 597
ACCUSEAL 60.0	60.0		0366 6110 600
ACCUSEAL 60.3	60.3		0366 6110 603
ACCUSEAL 60.5	60.5		0366 6100 605
ACCUSEAL 60.6	60.6		0366 6110 606
ACCUSEAL 61.4	61.4	0366 6100 614	
ACCUSEAL 61.6	61.6		0366 6100 616
ACCUSEAL 62.1	62.1	0366 6140 621	0366 6110 621
ACCUSEAL 62.3	62.3		0366 6100 623
ACCUSEAL 62.9	62.9	0366 6100 629	0366 6120 629
ACCUSEAL 64.9	64.9	0366 6100 649	0366 6110 649
ACCUSEAL 65.3	65.3		0366 6100 653
ACCUSEAL 65.6	65.6	0366 6100 656	0366 6110 656
ACCUSEAL 66.8	66.8		0366 6120 668
ACCUSEAL 68.4	68.4		0366 6100 684
ACCUSEAL 68.9	68.9	0366 6100 689	
ACCUSEAL 69.1	69.1		0366 6100 691
ACCUSEAL 69.4	69.4	0366 6100 694	
ACCUSEAL 69.7	69.7		0366 6100 697
ACCUSEAL 69.9	69.9		0366 6110 699
ACCUSEAL 70.6	70.6	0366 6110 706	0366 6120 706



- 1 High-strength fastener hardware with corrosive resistant coating
- 2 Improved clamp performance for thicker pipes on larger pipe gaps
- 3 Easy to assemble, only one assembly torque point
- 4 Reaction block serves as a defined stop, avoiding pipe deformation

Extra seal clamp

The NORMACONNECT® DuraSeal offers extra seal and clamp load performance to meet or exceed durability requirements without permanent distortion to exhaust members. Designed for applications with thicker pipe walls and larger pipe assembly gaps, it is ideal for applications with limited

packaging space.



Advantages at a glance

- Exclusive reaction block provides a full 360° distribution
- Simple, effective way to connect exhaust system components
- Designed for part-in-assembly pre-attachment
- Pre-assembled for easy installation
- Provides joint serviceability; no permanent distortion

Applications

- For high durability requirements
- Improved clamp performance for applications with thicker pipe walls and larger pipe assembly gaps
- Ideal for applications with limited packaging space
- Pipes, mufflers and converters

Materials

- 409 stainless steel
- 304 stainless steel (on request)

Information

- Diameter range: 50.8 mm (2") up to 127 mm (5")
- 7.9 mm (5/16") slotted hex screw

Technical data & Ordering information

NORMACONNECT® DURASEAL			
Designation	Diameters		409 Stainless Steel Product No.
	in mm	in inches	
DURASEAL 50.8	50.8	2"	0371 0001 056
DURASEAL 57.15	57.15	2 1/4"	0371 0001 062
DURASEAL 63.5	63.5	2 1/2"	0371 0003 068
DURASEAL 69.85	69.85	2 3/4"	0371 0003 075
DURASEAL 76.2	76.2	3"	0371 0004 081
DURASEAL 88.9	88.9	3 1/2"	0371 0000 093
DURASEAL 101.6	101.6	4"	0371 0001 107
DURASEAL 114.3	114.3	5"	0371 0000 132



- 1 Provides OE with a robust design alternative to flat flange
- 2 Provides rotational and axial alignment flexibility

Robust alternative clamp

The NORMACONNECT® AccuLock exhaust clamp provides a robust alternative to flat flanges with enhanced assembly flexibility, lower weight and improved overall value. Designed for use in low leak, pre- and after-treatment (catalyst) applications. Uses less space than a flat flange joint and has positive axial retention.

Advantages at a glance

- Enhanced assembly flexibility, lower weight, improved overall value
- Positive axial retention
- Uses less space than a flat flange joint

Applications

Designed for use in low leak, pre- and after-treatment (catalyst) applications

Materials

- Aluminized steel
- 409 stainless steel
- 430 stainless steel

Information

Available in standard industry sizes from 55 mm (2 1/5") up to 387.6 mm (15 1/3")

Technical data & Ordering information

NORMACONNECT® ACCULOCK					
Designation	Diameters		Aluminized Steel Product No.	409 Stainless Steel Product No.	430 Stainless Steel Product No.
	in mm	in inches			
ACCULOCK 55	55	2 1/5"	0370 0000 055		
ACCULOCK 63.5	63.5	2 1/2"	0370 0001 064		
ACCULOCK 88.9	88.9	3 1/2"	0370 0002 089	0370 0000 089	
ACCULOCK 336.8	336.8	13 1/3"			0370 0001 337
ACCULOCK 362.2	362.2	14 1/3"			0370 0001 362
ACCULOCK 387.6	387.6	15 1/3"			0370 0001 388

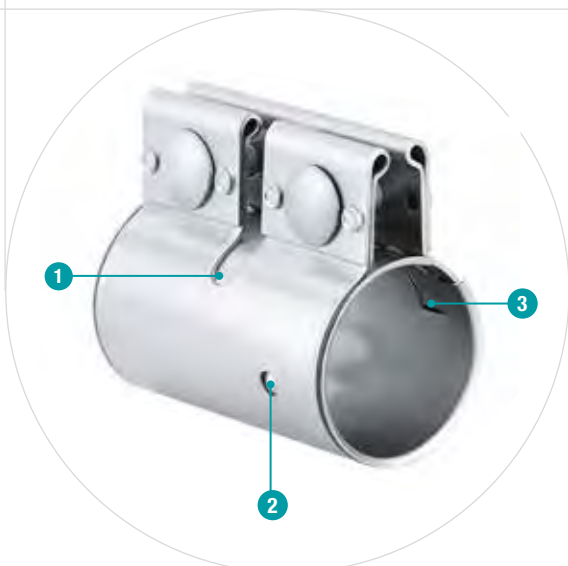

- 1 "U" slot to accommodate diameter differences
- 2 Dimple on the inner sleeve to engage with the outer band
- 3 Patented gasket



Joining exhaust system components

The NORMACONNECT® Euro Coupler is an effective way to join exhaust system components without the need for pipe flares/slip joints or slotting. This clamp offers superior clamp load capability and a serviceable joint. Allows for quick assembly and service of exhaust pipes. It provides significant resistance to longitudinal and rotational movement of pipes.

Advantages at a glance

- No need for pipe sizing or slotting
- Patented gasket with proven sealing ability to reduce leak rates
- Preamsembled unit – easy, reliable installation
- Superior clamp load capability

Applications

Effective way to join pipe to pipe connections of same diameter in an exhaust system.

Materials

W1	W2	W3	W4	W5
		x		

Technical data & Ordering information

NORMACONNECT® EUROCOUPLER			
Width	Description	Nominal diameter	W3 Product No.
		in mm	
88,7	EURO COUPLER 40-441/88	40	0367 6005 040
	EURO COUPLER 45-441/88	45	0367 6009 045
	EURO COUPLER 50-441/88	50	0367 6010 050
	EURO COUPLER 55-441/88	55	0367 6008 055
	EURO COUPLER 60-441/88	60	0367 6011 060
	EURO COUPLER 65-441/88	65	0367 6022 065
	EURO COUPLER 70-441/88	70	0367 6033 070

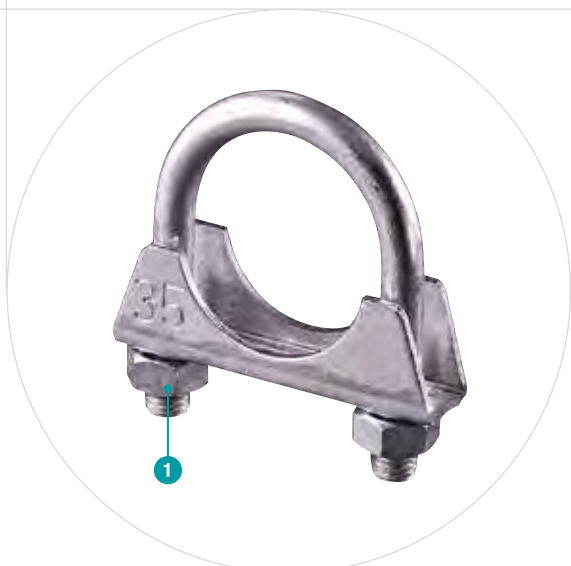

1 Pre-mounted screw and nuts

Exhaust system pipe clamp

The NORMACONNECT® Pipe clamp M8/M10 meets quality standards, which are suitable for use with a wide range of pipe diameters. Pipe clamps are not only used in exhaust systems.

Applications

- Exhaust systems
- Mounting of signage
- TV antennas/aerials

Advantages at a glance

- Hexagonal wheel for better maintenance of the U
- Completely assembled
- Suitable for use with a wide range of pipe diameters

Materials

W1	W2	W3	W4	W5
x			X	

Technical data & Ordering information

NORMACONNECT® PIPE CLAMP M8/M10			
Designation	Diameter in mm	W1 Product No.	W4 Product No.
PIPE CLAMP M8 32	32	08937481032	08937411032
PIPE CLAMP M8 35	35	08937481035	08937411035
PIPE CLAMP M8 38	38	08937481038	08937411038
PIPE CLAMP M8 40	40	08937481040	08937411040
PIPE CLAMP M8 42	42	08937481042	08937411042
PIPE CLAMP M8 44	44	08937481044	08937411044
PIPE CLAMP M8 45	45	08937481045	08937411045
PIPE CLAMP M8 48	48	08937481048	08937411048
PIPE CLAMP M8 52	52	08937481052	08937411052
PIPE CLAMP M8 54	54	08937481054	08937411054
PIPE CLAMP M8 57	57	08937481057	08937411057
PIPE CLAMP M8 60	60	08937481060	08937411060
PIPE CLAMP M8 65	65	08937481065	08937411065
PIPE CLAMP M8 70	70	08937481070	08937411070
PIPE CLAMP M8 76	76	08937481076	08937411076
PIPE CLAMP M10 90	90	08937481090	
PIPE CLAMP M10 115	115	08937481115	
PIPE CLAMP M10 127	127	08937481127	
PIPE CLAMP M10 140	140	08937481140	

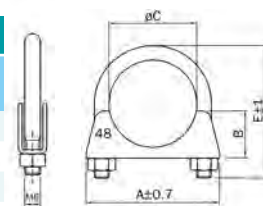

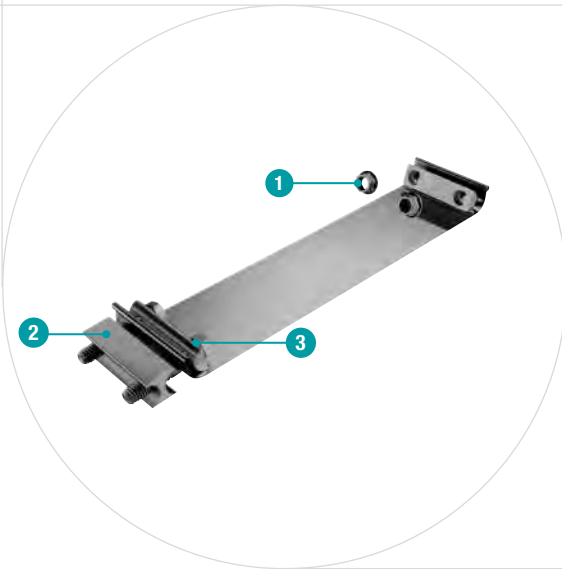

- 1 High-strength, plated Grade 8 fasteners
- 2 The original invented reaction block technology creates a complete “inner circle seal” when clamp is secured
- 3 Pre-attached hardware for fast, easy and accurate installation

Wide band exhaust clamps

The NORMACONNECT® EasySeal offers the best value in wideband exhaust clamps. Used for joining exhaust members of the same diameter. The unique design makes for fast, easy and accurate installation.

Advantages at a glance

- Patented design makes for fast, easy and accurate installation
- there's no need to separate pipes or exhaust members before clamping
- Replaces U-bolts and clamps
- With pre-attached hardware
- Ideal, service specific design
- Flat, packaged, easy to store
- Easy, fast, accurate installation
- Unique sealing performance
- Durable installation without damage to pipe ends

Applications

To connect exhaust system components

Materials

Band in bright finish stainless steel or matt finish aluminized carbon steel.

Information

Available in standard industry sizes from 50.8 mm (2") up to 203.2 mm (8")

Technical data & Ordering information

NORMACONNECT® EASYSEAL			
Designation	Diameters		409 Stainless Steel Product No.
	in mm	in inches	
EASYSEAL 50.8	50.8	2"	0368 6000 051
EASYSEAL 57.15	57.15	2 1/4"	0368 6000 056
EASYSEAL 63.5	63.5	2 1/2"	0368 6000 064
EASYSEAL 69.85	69.85	2 3/4"	0368 6000 069
EASYSEAL 76.2	76.2	3"	0368 6000 076
EASYSEAL 88.9	88.9	3 1/2"	0368 6000 089
EASYSEAL 101.6	101.6	4"	0368 6000 102
EASYSEAL 114.3	114.3	5"	0368 6000 114
EASYSEAL 127	127	5"	0368 6000 127
EASYSEAL 152.4	152.4	6"	0368 6000 152
EASYSEAL 177.8	177.8	7"	0368 6000 178
EASYSEAL 203.2	203.2	8"	0368 6000 203



- 1 Pre-threaded nut bar provides tightening with only one assembly tool
- 2 360° seal through reaction block
- 3 Stepped clamp for flex to pipe connection (Lap Style)

NEW!

NORMACONNECT®

NEW

Flexible wide band exhaust clamp

The **NORMACONNECT® TORCTITE** stands out thanks to its durable clamping performance and superior clamp load capacities for pipes, flex and mufflers. It is available in two versions: with lap style joint for

connecting pipes with different diameters or to connect flex to pipe. And with butt style joint to connect pipes with the same diameter.

Advantages at a glance

- Pre-threaded nut bar provides tightening with only one assembly tool
- Can be used to connect pipes with different diameters
- Compatible with pipes, flex and mufflers
- 360° seal through reaction block
- Durable installation without damage to pipe ends (puckering)

Applications

Flex to pipe and pipe to pipe connections in exhaust systems

Materials

- 304SS band
- Aluminum Reaction block
- Carbon steel zinc plated bolt

Technical data & Ordering information

NORMACONNECT® TORCTITE - LAP STYLE JOINT			
Designation	Diameters		Product No.
	in mm	in inches	
TORCTITE LS 50.8	50.8	2"	0368 6112 051
TORCTITE LS 52.7	57.2	2 1/4"	0368 6103 057
TORCTITE LS 63.5	63.5	2 1/2"	0368 6111 064
TORCTITE LS 69.9	69.9	2 3/4"	0368 6105 070
TORCTITE LS 76.2	76.2	3"	0368 6110 076
TORCTITE LS 88.9	88.9	3 1/2"	0368 6113 089
TORCTITE LS 101.6	101.6	4"	0368 6125 102
TORCTITE LS 114.3	114.3	4 1/2"	0368 6110 114
TORCTITE LS 127	127	5"	0368 8125 127
TORCTITE LS 152.4	152.4	6"	0368 6120 152

NORMACONNECT® TORCTITE - BUTT STYLE JOINT			
Designation	Diameters		Product No.
	in mm	in inches	
TORCTITE BS 50.8	50.8	2"	0368 0300 051
TORCTITE BS 52.7	57.2	2 1/4"	0368 0300 057
TORCTITE BS 63.5	63.5	2 1/2"	0368 0302 064
TORCTITE BS 69.9	69.9	2 3/4"	0368 0302 070
TORCTITE BS 76.2	76.2	3"	0368 0301 076
TORCTITE BS 88.9	88.9	3 1/2"	0368 0302 089
TORCTITE BS 101.6	101.6	4"	0368 0303 102
TORCTITE BS 114.3	114.3	4 1/2"	0368 0304 114
TORCTITE BS 127	127	5"	0368 0304 127
TORCTITE BS 152.4	152.4	6"	0368 0304 152

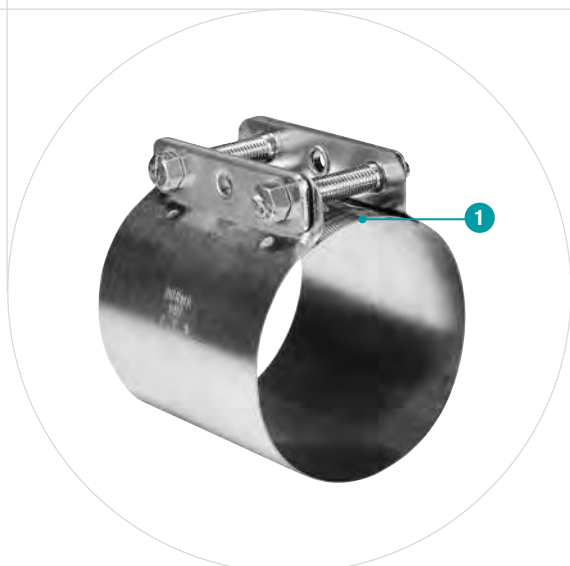

- 1 Bridge**
– good hose/sleeve coverage
- 2 Design protects hoses/sleeves**
– clamping force is distributed across a wide area
– prevents damage to components being clamped
– excellent transverse rigidity

Wide-band hose clamps in accordance with DIN 3017-5

Used in conjunction with a rubber sleeve, NORMACONNECT® BRS wide-band hose clamps are the ideal choice for connecting pipes with smooth ends. They connect cast iron and steel pipes just as securely as plastic or glass pipes and without any welding.

NORMACONNECT® wide-band hose and retaining clamps are produced with standardized band widths and materials. The progressive ratio is 1 mm in the case of a single-part version. Up to a clamping diameter of 300 mm, the clamps are supplied in rolled-up form. With clamping diameters of 301 mm and upwards, they are supplied in stretched-out form.

Advantages at a glance

- Extremely wide band
- Clamping force distributed over a large area
- High level of transverse rigidity
- Single-part and multi-part versions

Applications

- Machine building
- White goods
- Food and beverage industry
- Agricultural machines
- Engine manufacturing
- Exhaust air technology
- Suction systems
- Laboratory technology
- Drainage technology

Materials

W1	W2	W3	W4	W5
	x		x	

Material	Corrosion resistance in salt spray testing
W2	Min. 72 h
W4	Min. 240 h

Bolts

NORMACONNECT® BRS		
Band width	Sz in the case of W2	Sk in the case of W4
48	M6 x 38 Sz	M6 x 45 Sk
54	M8 x 47 Sz	M8 x 50 Sk
65	M8 x 47 Sz	M8 x 50 Sk

Technical data

NORMACONNECT® BRS				
Band width in mm	Minimum diameter in mm	Static tightening torque in Nm	Material thickness in mm	
			W2	W4
48	50	4	0.4	0.5
54	50	12	0.4	0.5
65	50	12	0.4	0.5

Ordering information

	1. Type	2. Clamping range	3. Band width	4. Material	5. Bolt
Example	BRS	55	48	W2	Sz



- 1 Cover band**
– optimum distribution of clamping forces
- 2 Closure**
- 3 profile segments**
– ease of assembly



The SVS STC-type closure is a cost effective alternative to conventional T-bolt closures.

Profile clamp with cover band

The NORMACONNECT® V profile clamps are reliable and time-effective connection elements for industrial and automotive use. They are made to customer requirements and can be supplied with various profiles, band widths and closure types.

Advantages at a glance

- Low friction losses
- Robust precision components
- Consistently high material quality
- State-of-the-art automated manufacturing
- Highly competitively priced

Applications

- Automotive: Turbocharger – catalytic converter connection
- Automotive: Exhaust manifold
- Industry: Bulk material container
- Industry: Bypass filter unit

Materials

Code	Closures			Closure components	Profile segments/ Cover band
	STC	QRC	SVS		
W4	•	•	•	Stainless steel	Stainless steel

ISO	DIN	AISI	BS	AFNOR
X5 CrNi 18-10	1.4301	304	304 S 15	Z6 CN 18-09

Product's method of operation

The profile clamp's method of operation is based on the principle of an inclined plane. When the closure bolt is tightened, this exerts circumferential force on the profile segments. The two halves of the flange are pressed together by means of the profile (see diagram below). The circumferential force that is exerted is converted into considerably higher axial force.

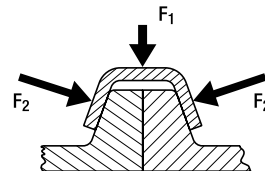

All profiles at a glance

Single-part 3 profile segments
Available up to diameter 300 mm

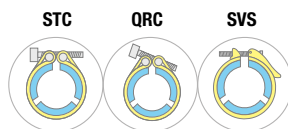

Two-part 2 profile segments
Available from diameter 200 mm up to 500 mm

Example of flange designs

Use of gasket may be required in some applications. Support and advice on gasket selection can be provided.

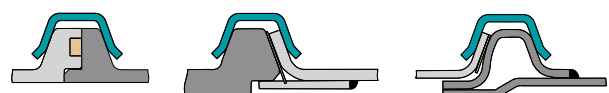

Profile types

4.0 b		≥ ø 89		5.0 a		≥ ø 82		5.3 b		≥ ø 110		6.0 a		≥ ø 125	
	20 mm	25 mm		20 mm	25 mm		20 mm	25 mm		20 mm	25 mm		20 mm	25 mm	
STC	•		STC	•		STC	•		STC	•		STC	•		
QRC	•		QRC	•		QRC	•		QRC	•		QRC	•		
SVS	•		SVS	•		SVS	•		SVS	•		SVS	•		
6.6 b		≥ ø 100		9.2 a		≥ ø 100		10.2 a		≥ ø 130		14.5 a		≥ ø 105	
	20 mm	25 mm		20 mm	25 mm		20 mm	25 mm		20 mm	25 mm		20 mm	25 mm	
STC	•		STC		•	STC		•	STC		•	STC		•	
QRC	•		QRC		•	QRC		•	QRC		•	QRC		•	
SVS	•		SVS		•	SVS		•	SVS		•	SVS		•	

The inner profile diameter can be freely selected in millimeter increments. All profiles can be supplied with a diameter of up to ø 500 mm. Please refer to the relevant profile diagram in the table below to find out the minimum diameter permissible for that profile.

Profile clamps can be supplied with cover bands measuring 20 mm or 25 mm in width.

The table above indicates which cover band is suitable for which profile.

Examples of flange structures

Inner profile ø		Flange 1				Flange 2				Flange 3				Flange 4				
Profile ø = flange ø + 2 x gap width																		
Profile type	Profile ø (mm)	W (mm)	H (mm)	R (mm)	T (mm)	W (mm)	H (mm)	R (mm)	T (mm)	W (mm)	H (mm)	R (mm)	T (mm)	W (mm)	H (mm)	R (mm)	T (mm)	
4.0b	≥ 100	5.1	7.5			5.1	8	2	2	5.1	7.5	1	1	Not recommended				
5.0a	≥ 100	6.1	4.6	6.1	4.6	1.5	1.5	6.1	4.6	1	1	6.1	4.6	1.5	1.5			
5.3b	≥ 110	6.4	7.3	6.4	7.8	2	2	6.4	7.3	1.5	1.5	6.4	7.8	2	2			
6.0a	≥ 125	7.1	4	7.1	4	1.5	1.5	Not recommended				7.1	4	1.5	1.5			
6.5a	≥ 130	7.6	8.3	7.6	8.8	2	2	7.6	8.3	1.5	1.5	7.6	8.8	2	2			
6.6b	≥ 100	7.7	6.6	7.7	6.6	1.5	1.5	7.7	6.6	1.5	1.5	7.7	6.6	1.5	1.5			
7.9b	≥ 100	9	5.7	9	6.2	2	2	9	5.7	1.5	1.5	9	6.2	2	2			
9.2a	≥ 100	10.3	7.3	10.3	7.8	2	2	10.3	7.8	2	2	10.3	7.8	2	2			
10.2a	≥ 130	11.3	7.3	11.3	7.8	2	2	11.3	7.8	2	2	11.3	7.8	2	2			
14.5a	≥ 105	15.6	7.4	15.6	7.9	2	2	15.6	7.9	2	2	Not recommended						
Abbreviations:		W = overall flange width H = overall flange height				R = flange radius				T = flange thickness								

Technical information

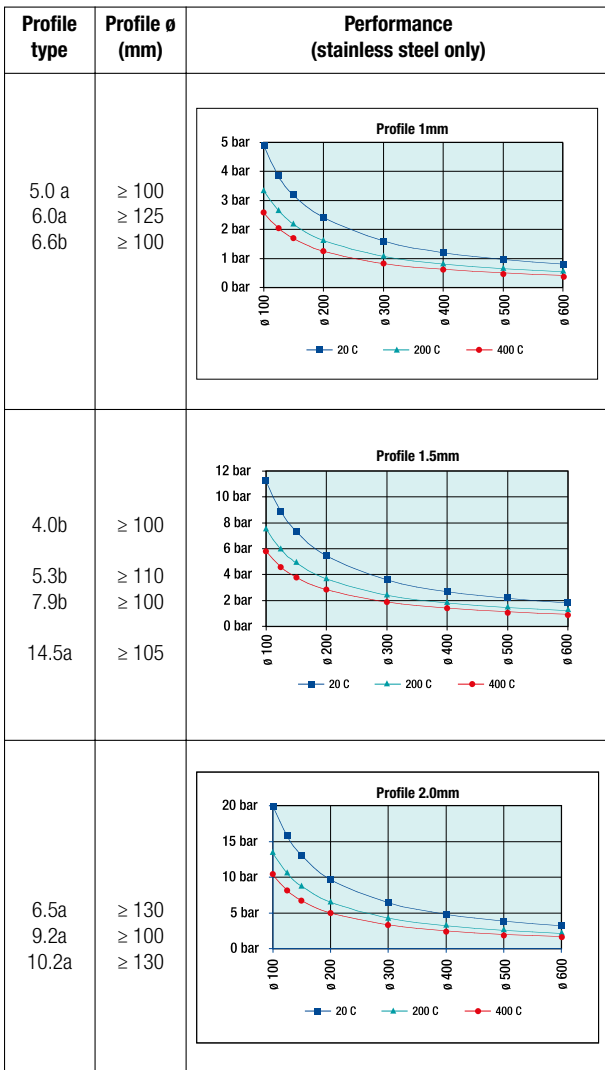

1. Determine the **application or test pressure**.
2. Determine the **max. operating temperature** to which the profile clamp will be exposed.
(Note: The profile clamps presented in this catalogue have been designed for a maximum operating temperature of 400°C.)
3. Calculate the required inner diameter of the profile as follows: outer flange diameter + 3 mm
4. Using the diagrams on the left. Check whether the profile thickness you have selected will be sufficient.
(Note: The result only represents an initial approximation based on static pressures and ideal operating conditions.)

Other factors may come into play, such as:

- Shape of and material used for sealing measures
- Roughness of flange surface
- Operating temperatures
- Bending moments
- Pressure surges/Vibrations
- Safety requirements

Based on these factors, you may decide that a thicker profile is necessary. The SVS closure is only recommended for low pressures (e.g., vacuum applications).

5. The tables below provide information on the tightening torques for the various closure types and bolt sizes.
- 5.1. Recommended tightening torque for STC & QRC-type closures:

Band width	Bolt	Tightening torque
20 mm	M 6	6 Nm
25 mm	M 8	12 Nm

- 5.2 SVS closing force:

Bolt	Force
M 6	≈ 80 Nm

Example of application:

- Operating pressure: 4 bar (static)
- Temperature: 20 °C
- Profile type: 4.0b
- Profile thickness: 1.5 mm
- Flange diameter: $\phi 197$ mm
- Inner profile diameter: $\phi 200$

Max. permissible pressure at 20 °C:

- 5.4 bar > 4 bar :OK

Technical data & Ordering information

NORMACONNECT® V STC – Single-part design

Min. profile type	Profile Ø (mm)	W4 Product No.
		STC
4.0b	≥ 89	0611 2043 ...
5.0a	≥ 82	0611 2032 ...
5.3b	≥ 110	0611 2078 ...
6.0a	≥ 125	0611 2004 ...
6.5a	≥ 130	0611 4015 ...
6.6b	≥ 100	0611 2031 ...
7.9b	≥ 100	0611 2099 ...
9.2a	≥ 100	0611 4009 ...
10.2a	≥ 130	0611 4081 ...
14.5a	≥ 105	0611 4028 ...

Single-part design • 3 segments • Cover band • Inner profile diameter $\varnothing \leq 300$ mm
 " ... = \varnothing without decimals in mm "

NORMACONNECT® V STC – Two-part design

Profile type	W4 Product No.
	STC
4.0b	0609 2043 ...
5.0a	0609 2032 ...
5.3b	0609 2078 ...
6.0a	0609 2004 ...
6.5a	0609 4015 ...
6.6b	0609 2031 ...
7.9b	0609 2099 ...
9.2a	0609 4009 ...
10.2a	0609 4081 ...
14.5a	0609 4028 ...

Two-part version* • 2 segments • No cover band • Inner profile diameter $\varnothing 200 - 500$ mm
 " ... = \varnothing without decimals in mm "

Application areas

NORMACONNECT® V profile clamps are quick-release connecting elements for flanges and represent an economical alternative to conventional bolted flange connections.



Automotive: Turbocharger – catalytic converter connection

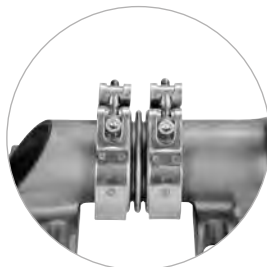

Automotive: Exhaust manifold



Industry: Bulk material container



Industry: Bypass filter unit

QRC



The revolutionary new QRC-type closure offers significant advantages over conventional T-bolt solutions.

Advantages at a glance

- Rapid closing and opening
- Captive closure components
- Significantly shorter installation
- Closure bolt secured during tightening

Material

W4

NORMACONNECT® QRC – Single-part design

Min. profile type	Profile Ø (mm)	W4 Product No.
		QRC
4.0b	≥ 89	0615 2043 ...
5.0a	≥ 82	0615 2032 ...
5.3b	≥ 110	0615 2078 ...
6.0a	≥ 125	0615 2004 ...
6.5a	≥ 130	0615 4015 ...
6.6b	≥ 100	0615 2031 ...
7.9b	≥ 100	0615 2099 ...
9.2a	≥ 100	0615 4009 ...
10.2a	≥ 130	0615 4081 ...
14.5a	≥ 105	0615 4028 ...

Single-part design • 3 segments • Cover band • Inner profile diameter Ø ≤ 300 mm
 "... = Ø without decimals in mm "

SVS



The SVS type includes an over-centre lever which enables manual installation.

Advantages at a glance

- Installation without tools
- Ideal for frequent handling

Material

W4

NORMACONNECT® SVS - Single-part design

Min. profile type	Profile Ø (mm)	W4 Product No.
		SVS
4.0b	≥ 89	0607 2043 ...
5.0a	≥ 82	0607 2032 ...
5.3b	≥ 110	0607 2078 ...
6.0a	≥ 125	0607 2004 ...
6.5a	≥ 130	0607 4015 ...
6.6b	≥ 100	0607 2031 ...
7.9b	≥ 100	0607 2099 ...
9.2a	≥ 100	0607 4009 ...
10.2a	≥ 130	0607 4081 ...
14.5a	≥ 105	0607 4028 ...

Single-part design • 3 segments • Cover band • Inner profile diameter Ø ≤ 300 mm
 "... = Ø without decimals in mm "

NORMACONNECT® SVS - Two-part design

Min. profile type	W4 Product No.
	SVS
4.0b	0605 2043 ...
5.0a	0605 2032 ...
5.3b	0605 2078 ...
6.0a	0605 2004 ...
6.5a	0605 4015 ...
6.6b	0605 2031 ...
7.9b	0605 2099 ...
9.2a	0605 4009 ...
10.2a	0605 4081 ...
14.5a	0605 4028 ...

Two-part version* • 2 segments • No cover band • Inner profile diameter Ø 200 - 500 mm
 "... = Ø without decimals in mm "



NORMAFIX® – Retaining Products

Versatile products for a whole host of applications

The NORMAFIX® range of clamps, clips and systems for retaining pipes, cables, cable harnesses and hoses are ready for action wherever they're needed – walls, ceilings or car bodies.



**Smooth round edges**

– easier to handle and safer to install

Variety of colors

– available in: black, white, red, yellow, green, blue

“Carbon Black” added in Black cable tie flange

– increased resistance to UV rays

– suitable for outdoor use

Quick and safe securing of cables in material PA 6.6

NORMAFIX® Cable tie for securing cables in electrical installations, industrial wiring, automotive, etc. Made of polyamide 6.6. Resistant to extreme temperatures and numerous external agents. Quick and safe assembly. The black cable tie offers excellent resistance to UV rays thanks to added “carbon black.”



Advantages at a glance

- Made of Polyamide 6.6 for optimum resistance to extreme temperatures, bases, oils, greases, etc.
- Bent rounded tip allows easier insertion through the head of the cable ties
- Low-friction material coefficient allows a faster installation

Applications

- Electrical installations
- Industrial cabling
- Automotive cabling
- Marine cabling
- Panel building
- Special applications

Materials

Material Polyamide 6.6

Characteristics of raw material polyamide PA 6.6

Working temperature: -45°C to 85°C

Tightening temperature: -10°C to 60°C

Max admissible point: 120°C*

Melting temperature: 256°C

Limiting Oxygen Index (LOI): 27%

Recovery of moisture: 2.7% to 50% relative humidity

Halogen free: Evaluated according to EN 50146. Flame retardancy according to UL 94-V2

*(for a short time)

Resistance to external agents

Excellent resistance to aromatic solvents, bases, oils, fat, petroleum products

Maintain limited contact with acid

Not resistant to phenol and chlorinated solvents

Resistance to UV (black colored cable ties)*

*The black cable ties are loaded with carbon black. Therefore they possess UV resistance according to standard ISO QUV-B 4892 (150 hours), equivalent to 3 years of exposure to sunlight. They are also particularly recommended for external applications.

Information

EC directives

The material used to produce our cable ties complies with the following EC directives:

- 2000/53/EC (VHU)
- 2002/65/UE (RoHS)
- 2002/96/EC (DEEE)
- 2006/95/EC

Technical data & Ordering information

NORMAFIX® CABLE TIES

Width	Designation	Length in mm	Maximum diameter in mm	Resistance to traction in Kgs	White Product No.	Black Product No.	Red Product No.	Yellow Product No.	Green Product No.	Blue Product No.
2.5	CABLE TIE 2.5 x 98	98	21	8	0860 0110 201	0860 0210 201	0860 0310 201	0860 0320 201	0860 0330 201	0860 0340 201
2.6	CABLE TIE 2.6 x 160	160	40	8	0860 0110 302	0860 0210 302				
3.5	CABLE TIE 3.5 x 140	140	35	13	0860 0110 401	0860 0210 401	0860 0310 401	0860 0320 401	0860 0330 401	0860 0340 401
	CABLE TIE 3.5 x 200	200	50	13	0860 0110 402	0860 0210 402	0860 0310 402	0860 0320 402	0860 0330 402	0860 0340 402
	CABLE TIE 3.5 x 290	290	80	13	0860 0110 403	0860 0210 403				
	CABLE TIE 3.5 x 370	370	103	13	0860 0110 404	0860 0210 404				
4.5	CABLE TIE 4.5 x 120	120	24	20	0860 0110 501	0860 0210 501				
	CABLE TIE 4.5 x 160	160	40	20	0860 0110 502	0860 0210 502				
	CABLE TIE 4.5 x 200	200	50	22	0860 0110 602	0860 0210 602	0860 0310 601	0860 0320 601	0860 0330 601	0860 0340 601
4.8	CABLE TIE 4.8 x 178	178	45	22	0860 0110 601	0860 0210 601				
	CABLE TIE 4.8 x 250	250	68	22	0860 0110 603	0860 0210 603				
4.5	CABLE TIE 4.5 x 290	290	79	22	0860 0110 604	0860 0210 604	0860 0310 602	0860 0320 602	0860 0330 602	0860 0340 602
	CABLE TIE 4.5 x 360	360	103	22	0860 0110 605	0860 0210 605				
4.8	CABLE TIE 4.8 x 390	390	106	22	0860 0110 606	0860 0210 606				
4.5	CABLE TIE 4.5 x 430	430	115	22	0860 0110 607	0860 0210 607				
7.8	CABLE TIE 7.8 x 180	180	45	55	0860 0110 702	0860 0210 702				
	CABLE TIE 7.8 x 240	240	63	55	0860 0110 703	0860 0210 703				
	CABLE TIE 7.8 x 300	300	80	55	0860 0110 704	0860 0210 704				
7.5	CABLE TIE 7.5 x 365	365	100	55	0860 0110 705	0860 0210 705				
	CABLE TIE 7.5 x 450	450	130	55	0860 0110 706	0860 0210 706				
	CABLE TIE 7.5 x 540	540	158	55	0860 0110 707	0860 0210 707				
	CABLE TIE 7.5 x 750	750	200	55	0860 0110 708	0860 0210 708				
9	CABLE TIE 9 x 780	780	233	77	0860 0110 801	0860 0210 801				
12.5	CABLE TIE 12.5 x 500	500	143	110	0860 0110 902	0860 0210 902				
	CABLE TIE 12.5 x 1000	1000	302	110	0860 0110 905	0860 0210 905				



Refer to pages 196 and 201.



- 1 Stainless steel barb**
– High strength and consistent performance
- 2 Curved tip**
– Easy to pick up from flat surface



Cable tie for high strength fixing

Made of Nylon 66 and 304 barb; this cable tie is a better choice for high strength applications

Advantages at a glance

- Stainless steel barb provides consistent performance and reliability and infinite adjustability through entire bundle range
- High strength and low thread force
- Stippled strap body prevents lateral movement on the bundle
- Curved tip is easy to pick up from flat surface and allows faster initial threading to speed installation

Applications

- Electrical installations
- Industrial cabling
- Automotive cabling
- Marine cabling
- Panel building
- Special applications

Materials

- Band: Nylon 66
- Locking barb: SS 304 (W4)

Information

Our cable ties comply with the following directives:

- ABS (Product Approval)
- CE (Certificate of conformity)
- UL62275 (Cable management systems)
- Lloyd's Register
- DNV
- DNV GL
- RoHS

Technical data & Ordering information

NORMAFIX® CABLE TIE WITH METAL BARB				
Width in mm	Designation	Length in mm	Black Product No.	White Product No.
2.4	CABLE TIE WITH METAL BARB 2.4 X 102	102	0892 7118 001	0892 7119 001
	CABLE TIE WITH METAL BARB 2.4 X 201	201	0892 7118 003	0892 7119 003
3.6	CABLE TIE WITH METAL BARB 3.6 X 155	155	0892 7118 006	0892 7119 006
	CABLE TIE WITH METAL BARB 3.6 X 200	200	0892 7118 009	0892 7119 009
	CABLE TIE WITH METAL BARB 3.6 X 284	284	0892 7118 007	0892 7119 007
4.8	CABLE TIE WITH METAL BARB 4.8 X 186	186	0892 7118 011	0892 7119 011
	CABLE TIE WITH METAL BARB 4.8 X 250	250	0892 7118 010	0892 7119 010
	CABLE TIE WITH METAL BARB 4.8 X 295	295	0892 7118 012	0892 7119 012
	CABLE TIE WITH METAL BARB 4.8 X 361	361	0892 7118 013	0892 7119 013
7.0	CABLE TIE WITH METAL BARB 7.0 X 221	221	0892 7118 016	0892 7119 016
	CABLE TIE WITH METAL BARB 7.0 X 378	378	0892 7118 018	0892 7119 018
	CABLE TIE WITH METAL BARB 7.0 X 699	699	0892 7118 021	0892 7119 021



Refer to pages 196 and 201.

Characteristics

- Material-Locking Barb: Stainless Steel 304
- Working Temp: -40°C to +85°C
- Color: Black and White
- Flammability: UL94V-2
- Other Properties: Halogen Free, UV-resistant (black cable ties)



- 1 Ball locking system for quick installation
- 2 No cutting edges: avoids damage to the cable electrical insulation



Cable tie for high strength fixing

Made of stainless steel AISI 304 or AISI 316 with ball locking system, that enables quick installation and low insertion effort. This kind of cable tie is characterized by a high resistance to high temperature, to flame and corrosion.

Advantages at a glance

- Ball-Lock type self-lock system, speeds installation
- Made entirely of high grade stainless steel, excellent corrosion and UV resistance.

Applications

- Cable and pipe fixing in shipbuilding, offshore, petrochemical plants, oil rigs, and environments with a risk of fire.
- Used as flame safety in electrical installations to fix the metal I.D. plates, which must be preserved in the event fire.
- Installations where high mechanical and UV resistance are required (photovoltaic).

Information

Our cable ties comply with the following directives:

- ABS (Product Approval)
- CE (Certificate of conformity)
- UL62275 (Cable management systems)
- Lloyd's Register
- DNV
- DNV GL
- RoHS

Materials

Band: Stainless steel AISI 304 or 316

Technical data & Ordering information

NORMAFIX® STAINLESS STEEL BALL LOCKING CABLE TIE				
Width in mm	Designation	Length in mm	W4 Product No.	W5 Product No.
4.6	STAINLESS STEEL BALL LOCKING CABLE TIE 4.6x200	200	08927012002	08927012047
	STAINLESS STEEL BALL LOCKING CABLE TIE 4.6x250	250	08927012003	08927012048
	STAINLESS STEEL BALL LOCKING CABLE TIE 4.6x350	350	08927012005	08927012049
	STAINLESS STEEL BALL LOCKING CABLE TIE 4.6x450	450	08927012007	08927012050
	STAINLESS STEEL BALL LOCKING CABLE TIE 4.6x650	650	08927012042	08927012051
	STAINLESS STEEL BALL LOCKING CABLE TIE 4.6x800	800	08927012043	08927012052
7.8	STAINLESS STEEL BALL LOCKING CABLE TIE 7.6x200	200	08927012010	08927012053
	STAINLESS STEEL BALL LOCKING CABLE TIE 7.6x250	250	08927012011	08927012054
	STAINLESS STEEL BALL LOCKING CABLE TIE 7.6x350	350	08927012013	08927012055
	STAINLESS STEEL BALL LOCKING CABLE TIE 7.6x500	500	08927012016	08927012056
	STAINLESS STEEL BALL LOCKING CABLE TIE 7.6x650	650	08927012044	08927012057
	STAINLESS STEEL BALL LOCKING CABLE TIE 7.6x800	800	08927012045	08927012058
	STAINLESS STEEL BALL LOCKING CABLE TIE 7.6x1000	1000	08927012046	08927012059



Refer to page 196.

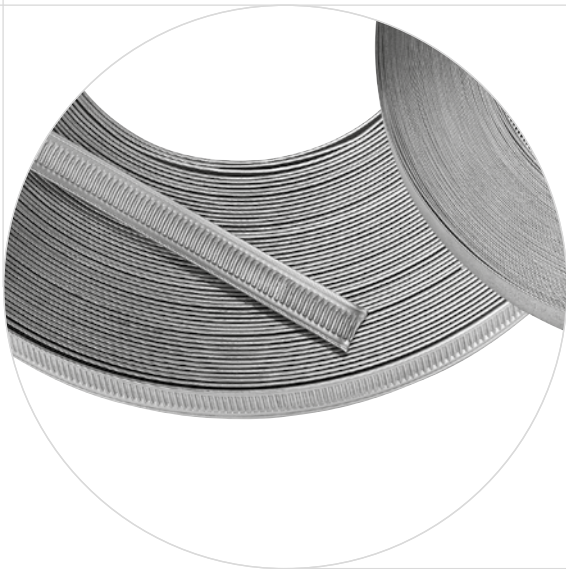

Continuous band available in smooth version or with thread stamping throughout

5 different closure types to suit a huge variety of applications



Continuous band clamping system

Consisting of a continuous band, the **NORMAFIX®** **NORMETTA®** system is able to adapt itself to the shape and size of various objects. 5 different types of closure are available to choose from. The system is particularly suitable for carrying out retaining and repair work under difficult and extreme conditions.



Advantages at a glance

- Flexible and versatile
- Can be installed under difficult conditions

Applications

- Irrigation systems
- Railway industry
- Building machines
- Pump and filter
- Retaining applications; sealing pipes during repair work
- Attaching signs and containers
- Binding hoses

Materials

W1	W2	W3	W4	W5
x	x	x	x	

Product and closure types

The continuous band is available in a 30 m roll and as either a smooth version with a range of band widths or a version with thread stamping throughout (with 12 mm band width only). It can also be supplied in different material grades.

Smooth band

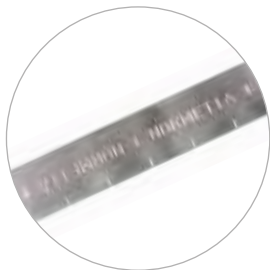

To be used with the buckles NB-A W1, NB-D W4 and NB-H W4.

NORMAFIX® NORMETTA SMOOTH BAND					
Width	Thickness	Designation	Length in m	W1 Product No.	W4 Product No.
5	0.35	NORMETTA SMOOTH BAND 30M/5 W1	30	0560 8500 004	
9	0.44	NORMETTA SMOOTH BAND 30M/9 W1	30	0560 8500 001	
	0.5	NORMETTA SMOOTH BAND 30M/9 W4	30		0560 5000 009
13	0.7	NORMETTA SMOOTH BAND 30M/13 W4	30		0560 5000 013
16	0.7	NORMETTA SMOOTH BAND 30M/16 W4	30		0560 5000 016
19	0.7	NORMETTA SMOOTH BAND 30M/19 W4	30		0560 5000 019



Refer to pages 190 and 196.

Stamped band



To be used with the buckles NB-G W3

NORMAFIX® NORMETTA STAMPED BAND					
Width	Thickness	Designation	Length in m	Resistance to traction in N	W3 Product No.
12	0.8	NORMETTA STAMPED BAND 30M/12 W3	30	2600 N	0560 8566 003



Refer to page 196.

Perforated Band



To be used with buckles NB-K W2.

NORMAFIX® NORMETTA PERFORATED BAND						
Width	Thickness	Designation	Length in m	Resistance to traction in N	W2 Product No.	W4 Product No.
8	0.6	NORMETTA PERFORATED BAND 25M/8 W2	25	790 N	0817 7020 001	
	0.6	NORMETTA PERFORATED BAND 25M/8 W4	25	790 N		0817 7022 001
13	0.6	NORMETTA PERFORATED BAND 25M/13 W4	25	850 N		0817 7022 002
14	0.6	NORMETTA PERFORATED BAND 25M/14 W2	25	850 N	0817 7020 002	



Refer to page 196.

NB-A



Closure type NB-A

Suitable for less demanding applications such as attaching signs and sealing low-pressure hoses. Can be re-used.

For bands: 5, 9 mm

Required tools: Steel pin, angled screwdriver or pliers, plate shears

NORMAFIX® NB-A		
For Band width	Designation	W1 Product No.
5	NB-A5	0560 8520 002
9	NB-A9	0560 8520 000

NB-D



Closure type NB-D

Suitable for attaching signs and containers to pipes and hoses as well as binding hoses.

For bands: 9, 13, 16, 19 mm

Required tools: Clamping and cutting tool; hammer

NORMAFIX® NB-D		
For Band width	Designation	W4 Product No.
9	NB-D/9	0560 8550 009
13	NB-D/13	0560 8550 013
16	NB-D/16	0560 8550 016
19	NB-D/19	0560 8550 019



Refer to page 196.

NB-G



Closure type NB-G

Suitable for applications with cramped installation conditions.

Can be re-used.

For stamped bands.

Required tools: Screwdriver or SW7 socket wrench and plate shears

NORMAFIX® NB-G		
For Band width	Designation	W3 Product No.
12	NB-G/12	0560 8565 003

NB-H



Closure type NB-H

An adjustable quick-release closure that enables fast and easy installation and removal. Can be re-used.

For bands: 16, 19 mm

Required tools: Screwdriver and plate shears

NORMAFIX® NB-H			
For Band width	Maximum diameter in mm	Designation	W1 Product No.
16 / 19	124	NB-H/124	0560 8558 124
	400	NB-H/400	0560 8558 400
	800	NB-H/800	0560 8558 800

NB-K



Closure type NB-K

Suitable for fixing suspended ventilation tubes.

For bands: 8, 13, 14 mm

Required tools: Screwdriver

NORMAFIX® NB-K			
For Band width	Designation	W2 Product No.	W4 Product No.
8	NB-K/8	0817 7019 003	0817 7021 003
13	NB-K/13		0817 7021 004
14	NB-K/14	0817 7019 004	



- 1 Form-fit, adjustable band**
- 2 Reinforced band ends**
– strengthen the band; prevent retaining sections from tearing or becoming loose during exposure to extremely high mechanical loads
- 3 Can be supplied with rubber profile as an option**
– improved form closure between clip and clamping fixture
– damping

Pipe retaining clips in accordance with DIN 3016

NORMAFIX® RS/RSGU pipe retaining clips are suitable for all kinds of fastening and retaining applications: pipes, cables, cable harnesses, cable protection pipes, hoses and other lines.



Advantages at a glance

- Easy installation and secure fastening
- Reinforced band ends for extremely high mechanical loads
- Rubber profile protects against vibrations and creeping water, is sound-absorbent and protects against contact corrosion

Applications

- Machine building
- White goods
- Chemical industry
- Irrigation systems
- Ship manufacturing
- Food and beverage industry
- Railway industry
- Agricultural machines
- Building machines
- Engine manufacturing
- Pump and filter
- Mining industry

Materials

W1	W2	W3	W4	W5
x		x*	x*	x

*W3 and W4 on request

Rubber profile

MATERIAL PROPERTIES OF EPDM RUBBER PROFILE		
Material properties		EPDM rubber profile
Tensile strength [N/mm ²]		Min. 8
Elongation at break [%]		350
Shore hardness A		70 ± 5
Temperature [°C]		-40 to +120
Resistance to:	Weather/Ozone	Very good
	Aging/UV	Very good
	Fuel storage	Not suitable
	Storage in oils and greases	Not suitable
	Alcohols	Good
	Acids	Good
	Alkalis	Good

Silicone rubber profile also available on request.

Bolts

The scope of delivery does not include bolts or nuts.

We recommend:

For NORMAFIX® RSGU with 12mm band width: M5 bolt

For NORMAFIX® RSGU with 15mm band width: M6 bolt

For NORMAFIX® RSGU with 20mm band width: M8 bolt

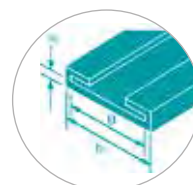

B = band width of clip
b₁ = width in mm
s₂ = material thickness in mm

Technical data & Ordering information

NORMAFIX® RSGU 1								
Band width	Designation	Clamping ranges		h1 ² ~	b1	s2	W1 Product No.	W5 Product No.
		in mm	in inches					
12	RSGU1. 6/12	6	1/4"	8.0+	15.0	1.2	0941 8912 006	0941 7712 006
	RSGU1. 8/12	8	5/16"	8.0+	15.0	1.2	0941 8912 008	0941 7712 008
	RSGU1. 10/12	10	3/8"	8.0+	15.0	1.2	0941 8912 010	0941 7712 010
	RSGU1. 12/12	12	1/2"	8.0+	15.0	1.2	0941 8912 012	0941 7712 012
	RSGU1. 13/12	13	1/2"	8.0+	15.0	1.2	0941 8912 013	0941 7712 013
	RSGU1. 14/12	14	9/16"	8.0+	15.0	1.2	0941 8912 014	0941 7712 014
	RSGU1. 15/12	15	5/8"	8.0+	15.0	1.2	0941 8912 015	0941 7712 015
	RSGU1. 16/12	16	5/8"	8.0+	15.0	1.2	0941 8912 016	0941 7712 016
	RSGU1. 18/12	18	3/4"	8.0+	15.0	1.2	0941 8912 018	0941 7712 018
	RSGU1. 19/12	19	3/4"	8.0+	15.0	1.2	0941 8912 019	0941 7712 019
	RSGU1. 20/12	20	13/16"	8.0+	15.0	1.2	0941 8912 020	0941 7712 020
	RSGU1. 21/12	21	13/16"	8.0+	15.0	1.2	0941 8912 021	0941 7712 021
RSGU1. 22/12	22	7/8"	8.0+	15.0	1.2	0941 8912 022	0941 7712 022	
15	RSGU1. 6/15	6	1/4"	11.2+	18.5	1.5	0941 8915 006	0941 7715 006
	RSGU1. 8/15	8	5/16"	11.2+	18.5	1.5	0941 8915 008	0941 7715 008
	RSGU1. 10/15	10	3/8"	11.2+	18.5	1.5	0941 8915 010	0941 7715 010
	RSGU1. 12/15	12	1/2"	11.2+	18.5	1.5	0941 8915 012	0941 7715 012
	RSGU1. 13/15	13	1/2"	11.2+	18.5	1.5	0941 8915 013	0941 7715 013
	RSGU1. 14/15	14	9/16"	11.2+	18.5	1.5	0941 8915 014	0941 7715 014
	RSGU1. 15/15	15	5/8"	11.2+	18.5	1.5	0941 8915 015	0941 7715 015
	RSGU1. 16/15	16	5/8"	11.2+	18.5	1.5	0941 8915 016	0941 7715 016
	RSGU1. 18/15	18	3/4"	11.2+	18.5	1.5	0941 8915 018	0941 7715 018
	RSGU1. 19/15	19	3/4"	11.2+	18.5	1.5	0941 8915 019	0941 7715 019
	RSGU1. 20/15	20	13/16"	11.2+	18.5	1.5	0941 8915 020	0941 7715 020
	RSGU1. 21/15	21	13/16"	11.2+	18.5	1.5	0941 8915 021	0941 7715 021
	RSGU1. 22/15	22	7/8"	11.2+	18.5	1.5	0941 8915 022	0941 7715 022
	RSGU1. 23/15	23	7/8"	11.2+	18.5	1.5	0941 8915 023	0941 7715 023
	RSGU1. 25/15	25	1"	11.2+	18.5	1.5	0941 8915 025	0941 7715 025
	RSGU1. 26/15	26	11/16"	11.2+	18.5	1.5	0941 8915 026	0941 7715 026
	RSGU1. 28/15	28	11/8"	11.2+	18.5	1.5	0941 8915 028	0941 7715 028
	RSGU1. 30/15	30	13/16"	11.2+	18.5	1.5	0941 8915 030	0941 7715 030
RSGU1. 32/15	32	11/4"	11.2+	18.5	1.5	0941 8915 032	0941 7715 032	
RSGU1. 34/15	34	15/16"	11.2+	18.5	1.5	0941 8915 034	0941 7715 034	
RSGU1. 35/15	35	13/8"	11.2+	18.5	1.5	0941 8915 035	0941 7715 035	
20	RSGU1. 10/20	10	3/8"	14.5+	25.0	2.0	0941 8920 010	0941 7720 010
	RSGU1. 12/20	12	1/2"	14.5+	25.0	2.0	0941 8920 012	0941 7720 012
	RSGU1. 13/20	13	1/2"	14.5+	25.0	2.0	0941 8920 013	0941 7720 013
	RSGU1. 14/20	14	9/16"	14.5+	25.0	2.0	0941 8920 014	0941 7720 014
	RSGU1. 15/20	15	5/8"	14.5+	25.0	2.0	0941 8920 015	0941 7720 015
	RSGU1. 16/20	16	5/8"	14.5+	25.0	2.0	0941 8920 016	0941 7720 016
	RSGU1. 18/20	18	3/4"	14.5+	25.0	2.0	0941 8920 018	0941 7720 018
	RSGU1. 19/20	19	3/4"	14.5+	25.0	2.0	0941 8920 019	0941 7720 019
	RSGU1. 20/20	20	13/16"	14.5+	25.0	2.0	0941 8920 020	0941 7720 020
	RSGU1. 22/20	22	7/8"	14.5+	25.0	2.0	0941 8920 022	0941 7720 022
	RSGU1. 23/20	23	7/8"	14.5+	25.0	2.0	0941 8920 023	0941 7720 023
	RSGU1. 24/20	24	15/16"	14.5+	25.0	2.0	0941 8920 024	0941 7720 024
	RSGU1. 25/20	25	1"	14.5+	25.0	2.0	0941 8920 025	0941 7720 025
	RSGU1. 28/20	28	11/8"	14.5+	25.0	2.0	0941 8920 028	0941 7720 028
	RSGU1. 30/20	30	13/16"	14.5+	25.0	2.0	0941 8920 030	0941 7720 030
	RSGU1. 32/20	32	11/4"	14.5+	25.0	2.0	0941 8920 032	0941 7720 032
	RSGU1. 34/20	34	15/16"	14.5+	25.0	2.0	0941 8920 034	0941 7720 034
	RSGU1. 35/20	35	13/8"	14.5+	25.0	2.0	0941 8920 035	0941 7720 035
RSGU1. 36/20	36	17/16"	14.5+	25.0	2.0	0941 8920 036	0941 7720 036	
RSGU1. 38/20	38	11/2"	14.5+	25.0	2.0	0941 8920 038	0941 7720 038	
RSGU1. 40/20	40	19/16"	14.5+	25.0	2.0	0941 8920 040	0941 7720 040	

Band width 9 mm and 25 mm available as standard

Additional diameters available on request

Alternative rubber profiles (e.g. silicone) available on request

RSGU 0



NORMAFIX® RSGU 0

Band width	Designation	Clamping ranges		h1 ² ~	b1	s2	W1 Product No.	W5 Product No.
		in mm	in inches					
12	RSGU0. 6/12	6	1/4"	8.0+	15.0	1.2	0940 8912 006	0940 7712 006
	RSGU0. 8/12	8	5/16"	8.0+	15.0	1.2	0940 8912 008	0940 7712 008
	RSGU0. 10/12	10	3/8"	8.0+	15.0	1.2	0940 8912 010	0940 7712 010
	RSGU0. 12/12	12	1/2"	8.0+	15.0	1.2	0940 8912 012	0940 7712 012
	RSGU0. 13/12	13	1/2"	8.0+	15.0	1.2	0940 8912 013	0940 7712 013
	RSGU0. 14/12	14	9/16"	8.0+	15.0	1.2	0940 8912 014	0940 7712 014
	RSGU0. 15/12	15	5/8"	8.0+	15.0	1.2	0940 8912 015	0940 7712 015
	RSGU0. 16/12	16	5/8"	8.0+	15.0	1.2	0940 8912 016	0940 7712 016
	RSGU0. 18/12	18	3/4"	8.0+	15.0	1.2	0940 8912 018	0940 7712 018
	RSGU0. 19/12	19	3/4"	8.0+	15.0	1.2	0940 8912 019	0940 7712 019
	RSGU0. 20/12	20	13/16"	8.0+	15.0	1.2	0940 8912 020	0940 7712 020
	RSGU0. 21/12	21	13/16"	8.0+	15.0	1.2	0940 8912 021	0940 7712 021
RSGU0. 22/12	22	7/8"	8.0+	15.0	1.2	0940 8912 022	0940 7712 022	
15	RSGU0. 6/15	6	1/4"	11.2+	18.5	1.5	0940 8915 006	0940 7715 006
	RSGU0. 8/15	8	5/16"	11.2+	18.5	1.5	0940 8915 008	0940 7715 008
	RSGU0. 10/15	10	3/8"	11.2+	18.5	1.5	0940 8915 010	0940 7715 010
	RSGU0. 12/15	12	1/2"	11.2+	18.5	1.5	0940 8915 012	0940 7715 012
	RSGU0. 13/15	13	1/2"	11.2+	18.5	1.5	0940 8915 013	0940 7715 013
	RSGU0. 14/15	14	9/16"	11.2+	18.5	1.5	0940 8915 014	0940 7715 014
	RSGU0. 15/15	15	5/8"	11.2+	18.5	1.5	0940 8915 015	0940 7715 015
	RSGU0. 16/15	16	5/8"	11.2+	18.5	1.5	0940 8915 016	0940 7715 016
	RSGU0. 18/15	18	3/4"	11.2+	18.5	1.5	0940 8915 018	0940 7715 018
	RSGU0. 19/15	19	3/4"	11.2+	18.5	1.5	0940 8915 019	0940 7715 019
	RSGU0. 20/15	20	13/16"	11.2+	18.5	1.5	0940 8915 020	0940 7715 020
	RSGU0. 21/15	21	13/16"	11.2+	18.5	1.5	0940 8915 021	0940 7715 021
	RSGU0. 22/15	22	7/8"	11.2+	18.5	1.5	0940 8915 022	0940 7715 022
	RSGU0. 23/15	23	7/8"	11.2+	18.5	1.5	0940 8915 023	0940 7715 023
	RSGU0. 25/15	25	1"	11.2+	18.5	1.5	0940 8915 025	0940 7715 025
	RSGU0. 26/15	26	11/16"	11.2+	18.5	1.5	0940 8915 026	0940 7715 026
	RSGU0. 28/15	28	11/8"	11.2+	18.5	1.5	0940 8915 028	0940 7715 028
	RSGU0. 30/15	30	13/16"	11.2+	18.5	1.5	0940 8915 030	0940 7715 030
RSGU0. 32/15	32	11/4"	11.2+	18.5	1.5	0940 8915 032	0940 7715 032	
RSGU0. 34/15	34	15/16"	11.2+	18.5	1.5	0940 8915 034	0940 7715 034	
RSGU0. 35/15	35	13/8"	11.2+	18.5	1.5	0940 8915 035	0940 7715 035	
20	RSGU0. 10/20	10	3/8"	14.5+	25.0	2.0	0940 8920 010	0940 7720 010
	RSGU0. 12/20	12	1/2"	14.5+	25.0	2.0	0940 8920 012	0940 7720 012
	RSGU0. 13/20	13	1/2"	14.5+	25.0	2.0	0940 8920 013	0940 7720 013
	RSGU0. 14/20	14	9/16"	14.5+	25.0	2.0	0940 8920 014	0940 7720 014
	RSGU0. 15/20	15	5/8"	14.5+	25.0	2.0	0940 8920 015	0940 7720 015
	RSGU0. 16/20	16	5/8"	14.5+	25.0	2.0	0940 8920 016	0940 7720 016
	RSGU0. 18/20	18	3/4"	14.5+	25.0	2.0	0940 8920 018	0940 7720 018
	RSGU0. 19/20	19	3/4"	14.5+	25.0	2.0	0940 8920 019	0940 7720 019
	RSGU0. 20/20	20	13/16"	14.5+	25.0	2.0	0940 8920 020	0940 7720 020
	RSGU0. 22/20	22	7/8"	14.5+	25.0	2.0	0940 8920 022	0940 7720 022
	RSGU0. 23/20	23	7/8"	14.5+	25.0	2.0	0940 8920 023	0940 7720 023
	RSGU0. 24/20	24	15/16"	14.5+	25.0	2.0	0940 8920 024	0940 7720 024
	RSGU0. 25/20	25	1"	14.5+	25.0	2.0	0940 8920 025	0940 7720 025
	RSGU0. 28/20	28	11/8"	14.5+	25.0	2.0	0940 8920 028	0940 7720 028
	RSGU0. 30/20	30	13/16"	14.5+	25.0	2.0	0940 8920 030	0940 7720 030
	RSGU0. 32/20	32	11/4"	14.5+	25.0	2.0	0940 8920 032	0940 7720 032
	RSGU0. 34/20	34	15/16"	14.5+	25.0	2.0	0940 8920 034	0940 7720 034
	RSGU0. 35/20	35	13/8"	14.5+	25.0	2.0	0940 8920 035	0940 7720 035
RSGU0. 36/20	36	17/16"	14.5+	25.0	2.0	0940 8920 036	0940 7720 036	
RSGU0. 38/20	38	11/2"	14.5+	25.0	2.0	0940 8920 038	0940 7720 038	
RSGU0. 40/20	40	19/16"	14.5+	25.0	2.0	0940 8920 040	0940 7720 040	

Band width 9 mm and 25 mm available as standard

Additional diameters available on request

Alternative rubber profiles (e.g. silicone) available on request

RSGU 2



NORMAFIX® RSGU 2								
Band width	Designation	Clamping ranges		h1 ² ~	b1	s2	W1 Product No.	W5 Product No.
		in mm	in inches					
12	RSGU2. 6/12	6	1/4"	8.0+	15.0	1.2	0942 8912 006	0942 7712 006
	RSGU2. 8/12	8	5/16"	8.0+	15.0	1.2	0942 8912 008	0942 7712 008
	RSGU2. 10/12	10	3/8"	8.0+	15.0	1.2	0942 8912 010	0942 7712 010
	RSGU2. 12/12	12	1/2"	8.0+	15.0	1.2	0942 8912 012	0942 7712 012
	RSGU2. 13/12	13	1/2"	8.0+	15.0	1.2	0942 8912 013	0942 7712 013
	RSGU2. 14/12	14	9/16"	8.0+	15.0	1.2	0942 8912 014	0942 7712 014
	RSGU2. 15/12	15	5/8"	8.0+	15.0	1.2	0942 8912 015	0942 7712 015
	RSGU2. 16/12	16	5/8"	8.0+	15.0	1.2	0942 8912 016	0942 7712 016
	RSGU2. 18/12	18	3/4"	8.0+	15.0	1.2	0942 8912 018	0942 7712 018
	RSGU2. 19/12	19	3/4"	8.0+	15.0	1.2	0942 8912 019	0942 7712 019
	RSGU2. 20/12	20	13/16"	8.0+	15.0	1.2	0942 8912 020	0942 7712 020
	RSGU2. 21/12	21	13/16"	8.0+	15.0	1.2	0942 8912 021	0942 7712 021
RSGU2. 22/12	22	7/8"	8.0+	15.0	1.2	0942 8912 022	0942 7712 022	
15	RSGU2. 6/15	6	1/4"	11.2+	18.5	1.5	0942 8915 006	0942 7715 006
	RSGU2. 8/15	8	5/16"	11.2+	18.5	1.5	0942 8915 008	0942 7715 008
	RSGU2. 10/15	10	3/8"	11.2+	18.5	1.5	0942 8915 010	0942 7715 010
	RSGU2. 12/15	12	1/2"	11.2+	18.5	1.5	0942 8915 012	0942 7715 012
	RSGU2. 13/15	13	1/2"	11.2+	18.5	1.5	0942 8915 013	0942 7715 013
	RSGU2. 14/15	14	9/16"	11.2+	18.5	1.5	0942 8915 014	0942 7715 014
	RSGU2. 15/15	15	5/8"	11.2+	18.5	1.5	0942 8915 015	0942 7715 015
	RSGU2. 16/15	16	5/8"	11.2+	18.5	1.5	0942 8915 016	0942 7715 016
	RSGU2. 18/15	18	3/4"	11.2+	18.5	1.5	0942 8915 018	0942 7715 018
	RSGU2. 19/15	19	3/4"	11.2+	18.5	1.5	0942 8915 019	0942 7715 019
	RSGU2. 20/15	20	13/16"	11.2+	18.5	1.5	0942 8915 020	0942 7715 020
	RSGU2. 21/15	21	13/16"	11.2+	18.5	1.5	0942 8915 021	0942 7715 021
	RSGU2. 22/15	22	7/8"	11.2+	18.5	1.5	0942 8915 022	0942 7715 022
	RSGU2. 23/15	23	7/8"	11.2+	18.5	1.5	0942 8915 023	0942 7715 023
	RSGU2. 25/15	25	1"	11.2+	18.5	1.5	0942 8915 025	0942 7715 025
	RSGU2. 26/15	26	11/16"	11.2+	18.5	1.5	0942 8915 026	0942 7715 026
	RSGU2. 28/15	28	11/8"	11.2+	18.5	1.5	0942 8915 028	0942 7715 028
	RSGU2. 30/15	30	13/16"	11.2+	18.5	1.5	0942 8915 030	0942 7715 030
RSGU2. 32/15	32	11/4"	11.2+	18.5	1.5	0942 8915 032	0942 7715 032	
RSGU2. 34/15	34	15/16"	11.2+	18.5	1.5	0942 8915 034	0942 7715 034	
RSGU2. 35/15	35	13/8"	11.2+	18.5	1.5	0942 8915 035	0942 7715 035	
20	RSGU2. 10/20	10	3/8"	14.5+	25.0	2.0	0942 8920 010	0942 7720 010
	RSGU2. 12/20	12	1/2"	14.5+	25.0	2.0	0942 8920 012	0942 7720 012
	RSGU2. 13/20	13	1/2"	14.5+	25.0	2.0	0942 8920 013	0942 7720 013
	RSGU2. 14/20	14	9/16"	14.5+	25.0	2.0	0942 8920 014	0942 7720 014
	RSGU2. 15/20	15	5/8"	14.5+	25.0	2.0	0942 8920 015	0942 7720 015
	RSGU2. 16/20	16	5/8"	14.5+	25.0	2.0	0942 8920 016	0942 7720 016
	RSGU2. 18/20	18	3/4"	14.5+	25.0	2.0	0942 8920 018	0942 7720 018
	RSGU2. 19/20	19	3/4"	14.5+	25.0	2.0	0942 8920 019	0942 7720 019
	RSGU2. 20/20	20	13/16"	14.5+	25.0	2.0	0942 8920 020	0942 7720 020
	RSGU2. 22/20	22	7/8"	14.5+	25.0	2.0	0942 8920 022	0942 7720 022
	RSGU2. 23/20	23	7/8"	14.5+	25.0	2.0	0942 8920 023	0942 7720 023
	RSGU2. 24/20	24	15/16"	14.5+	25.0	2.0	0942 8920 024	0942 7720 024
	RSGU2. 25/20	25	1"	14.5+	25.0	2.0	0942 8920 025	0942 7720 025
	RSGU2. 28/20	28	11/8"	14.5+	25.0	2.0	0942 8920 028	0942 7720 028
	RSGU2. 30/20	30	13/16"	14.5+	25.0	2.0	0942 8920 030	0942 7720 030
	RSGU2. 32/20	32	11/4"	14.5+	25.0	2.0	0942 8920 032	0942 7720 032
	RSGU2. 34/20	34	15/16"	14.5+	25.0	2.0	0942 8920 034	0942 7720 034
	RSGU2. 35/20	35	13/8"	14.5+	25.0	2.0	0942 8920 035	0942 7720 035
RSGU2. 36/20	36	17/16"	14.5+	25.0	2.0	0942 8920 036	0942 7720 036	
RSGU2. 38/20	38	11/2"	14.5+	25.0	2.0	0942 8920 038	0942 7720 038	
RSGU2. 40/20	40	19/16"	14.5+	25.0	2.0	0942 8920 040	0942 7720 040	

Band width 9 mm and 25 mm available as standard
 Additional diameters available on request
 Alternative rubber profiles (e.g. silicone) available on request

RSGUV 1

The **NORMAFIX**® RSGUV 1 can be pre-positioned on the hose. The locking device keeps the RSGUV 1 safely in place if it needs to be stocked or transported prior to its final assembly.



Available in band widths of 15 and 20 mm, in the same dimensions as our RSGU 1. This system can only be fixed by using a special tool.

Advantages at a glance

- Safe pre-assembly on the hose
- No unintentional opening of the clamp during handling or transportation

Materials

W1, W3, W4, W5



Refer to page 198.

RS 0



NORMAFIX® RS 0									
Band width	Designation	Clamping ranges		d	h12 ~	l	s	W1 Product No.	W5 Product No.
		in mm	in inches						
12	RS 0. 6/12	6	1/4"	5.3 (M5)	6.8+	5.0	0.5	0410 8912 006	0410 7712 006
	RS 0. 8/12	8	5/16"	5.3 (M5)	6.8+	5.0	0.5	0410 8912 008	0410 7712 008
	RS 0. 10/12	10	3/8"	5.3 (M5)	6.8+	5.0	0.5	0410 8912 010	0410 7712 010
	RS 0. 12/12	12	1/2"	5.3 (M5)	6.8+	5.0	0.5	0410 8912 012	0410 7712 012
	RS 0. 13/12	13	1/2"	5.3 (M5)	6.8+	5.0	0.5	0410 8912 013	0410 7712 013
	RS 0. 14/12	14	9/16"	5.3 (M5)	6.8+	5.0	0.5	0410 8912 014	0410 7712 014
	RS 0. 15/12	15	5/8"	5.3 (M5)	6.8+	5.0	0.5	0410 8912 015	0410 7712 015
	RS 0. 16/12	16	5/8"	5.3 (M5)	6.8+	5.0	0.5	0410 8912 016	0410 7712 016
	RS 0. 18/12	18	3/4"	5.3 (M5)	6.8+	5.0	0.5	0410 8912 018	0410 7712 018
	RS 0. 19/12	19	3/4"	5.3 (M5)	6.8+	5.0	0.5	0410 8912 019	0410 7712 019
	RS 0. 20/12	20	13/16"	5.3 (M5)	6.8+	5.0	0.5	0410 8912 020	0410 7712 020
	RS 0. 21/12	21	13/16"	5.3 (M5)	6.8+	5.0	0.5	0410 8912 021	0410 7712 021
	RS 0. 22/12	22	7/8"	5.3 (M5)	6.8+	5.0	0.5	0410 8912 022	0410 7712 022
15	RS 0. 6/15	6	1/4"	6.4 (M6)	9.7+	6.0	0.6	0410 8915 006	0410 7715 006
	RS 0. 8/15	8	5/16"	6.4 (M6)	9.7+	6.0	0.6	0410 8915 008	0410 7715 008
	RS 0. 10/15	10	3/8"	6.4 (M6)	9.7+	6.0	0.6	0410 8915 010	0410 7715 010
	RS 0. 12/15	12	1/2"	6.4 (M6)	9.7+	6.0	0.6	0410 8915 012	0410 7715 012
	RS 0. 13/15	13	1/2"	6.4 (M6)	9.7+	6.0	0.6	0410 8915 013	0410 7715 013
	RS 0. 14/15	14	9/16"	6.4 (M6)	9.7+	6.0	0.6	0410 8915 014	0410 7715 014
	RS 0. 15/15	15	5/8"	6.4 (M6)	9.7+	6.0	0.8	0410 8915 015	0410 7715 015
	RS 0. 16/15	16	5/8"	6.4 (M6)	9.7+	6.0	0.8	0410 8915 016	0410 7715 016
	RS 0. 18/15	18	3/4"	6.4 (M6)	9.7+	6.0	0.8	0410 8915 018	0410 7715 018
	RS 0. 19/15	19	3/4"	6.4 (M6)	9.7+	6.0	0.8	0410 8915 019	0410 7715 019
	RS 0. 20/15	20	13/16"	6.4 (M6)	9.7+	6.0	0.8	0410 8915 020	0410 7715 020
	RS 0. 21/15	21	13/16"	6.4 (M6)	9.7+	6.0	0.8	0410 8915 021	0410 7715 021
	RS 0. 22/15	22	7/8"	6.4 (M6)	9.7+	6.0	0.8	0410 8915 022	0410 7715 022
	RS 0. 23/15	23	7/8"	6.4 (M6)	9.7+	6.0	0.8	0410 8915 023	0410 7715 023
	RS 0. 25/15	25	1"	6.4 (M6)	9.7+	6.0	0.8	0410 8915 025	0410 7715 025
	RS 0. 26/15	26	11/16"	6.4 (M6)	9.7+	6.0	0.8	0410 8915 026	0410 7715 026
	RS 0. 28/15	28	11/8"	6.4 (M6)	9.7+	6.0	0.8	0410 8915 028	0410 7715 028
	RS 0. 30/15	30	13/16"	6.4 (M6)	9.7+	6.0	0.8	0410 8915 030	0410 7715 030
RS 0. 32/15	32	11/4"	6.4 (M6)	9.7+	6.0	0.8	0410 8915 032	0410 7715 032	
RS 0. 34/15	34	15/16"	6.4 (M6)	9.7+	6.0	0.8	0410 8915 034	0410 7715 034	
RS 0. 35/15	35	13/8"	6.4 (M6)	9.7+	6.0	0.8	0410 8915 035	0410 7715 035	
20	RS 0. 10/20	10	3/8"	8.4 (M8)	12.5+	8.5	0.8	0410 8920 010	0410 7720 010
	RS 0. 12/20	12	1/2"	8.4 (M8)	12.5+	8.5	0.8	0410 8920 012	0410 7720 012
	RS 0. 13/20	13	1/2"	8.4 (M8)	12.5+	8.5	0.8	0410 8920 013	0410 7720 013
	RS 0. 14/20	14	9/16"	8.4 (M8)	12.5+	8.5	0.8	0410 8920 014	0410 7720 014
	RS 0. 15/20	15	5/8"	8.4 (M8)	12.5+	8.5	0.8	0410 8920 015	0410 7720 015
	RS 0. 16/20	16	5/8"	8.4 (M8)	12.5+	8.5	0.8	0410 8920 016	0410 7720 016
	RS 0. 18/20	18	3/4"	8.4 (M8)	12.5+	8.5	0.8	0410 8920 018	0410 7720 018
	RS 0. 19/20	19	3/4"	8.4 (M8)	12.5+	8.5	0.8	0410 8920 019	0410 7720 019
	RS 0. 20/20	20	13/16"	8.4 (M8)	12.5+	8.5	0.8	0410 8920 020	0410 7720 020
	RS 0. 22/20	22	7/8"	8.4 (M8)	12.5+	8.5	0.8	0410 8920 022	0410 7720 022
	RS 0. 23/20	23	7/8"	8.4 (M8)	12.5+	8.5	0.8	0410 8920 023	0410 7720 023
	RS 0. 24/20	24	15/16"	8.4 (M8)	12.5+	8.5	0.8	0410 8920 024	0410 7720 024
	RS 0. 25/20	25	1"	8.4 (M8)	12.5+	8.5	0.8	0410 8920 025	0410 7720 025
	RS 0. 28/20	28	11/8"	8.4 (M8)	12.5+	8.5	1.0	0410 8920 028	0410 7720 028
	RS 0. 30/20	30	13/16"	8.4 (M8)	12.5+	8.5	1.0	0410 8920 030	0410 7720 030
	RS 0. 32/20	32	11/4"	8.4 (M8)	12.5+	8.5	1.0	0410 8920 032	0410 7720 032
	RS 0. 34/20	34	15/16"	8.4 (M8)	12.5+	8.5	1.0	0410 8920 034	0410 7720 034
	RS 0. 35/20	35	13/8"	8.4 (M8)	12.5+	8.5	1.0	0410 8920 035	0410 7720 035
RS 0. 36/20	36	17/16"	8.4 (M8)	12.5+	8.5	1.0	0410 8920 036	0410 7720 036	
RS 0. 38/20	38	11/2"	8.4 (M8)	12.5+	8.5	1.0	0410 8920 038	0410 7720 038	
RS 0. 40/20	40	19/16"	8.4 (M8)	12.5+	8.5	1.0	0410 8920 040	0410 7720 040	

Band width 9 mm and 25 mm available as standard
 Additional diameters available on request
 Alternative rubber profiles (e.g. silicone) available on request

RS 1



NORMAFIX® RS 1

Band width	Designation	Clamping ranges		d	h1 ² ~	l	s	W1 Product No.	W5 Product No.
		in mm	in inches						
12	RS 1. 6/12	6	1/4"	5.3 (M5)	6.8+	5.0	0.5	0411 8912 006	0411 7712 006
	RS 1. 8/12	8	5/16"	5.3 (M5)	6.8+	5.0	0.5	0411 8912 008	0411 7712 008
	RS 1. 10/12	10	3/8"	5.3 (M5)	6.8+	5.0	0.5	0411 8912 010	0411 7712 010
	RS 1. 12/12	12	1/2"	5.3 (M5)	6.8+	5.0	0.5	0411 8912 012	0411 7712 012
	RS 1. 13/12	13	1/2"	5.3 (M5)	6.8+	5.0	0.5	0411 8912 013	0411 7712 013
	RS 1. 14/12	14	9/16"	5.3 (M5)	6.8+	5.0	0.5	0411 8912 014	0411 7712 014
	RS 1. 15/12	15	5/8"	5.3 (M5)	6.8+	5.0	0.5	0411 8912 015	0411 7712 015
	RS 1. 16/12	16	5/8"	5.3 (M5)	6.8+	5.0	0.5	0411 8912 016	0411 7712 016
	RS 1. 18/12	18	3/4"	5.3 (M5)	6.8+	5.0	0.5	0411 8912 018	0411 7712 018
	RS 1. 19/12	19	3/4"	5.3 (M5)	6.8+	5.0	0.5	0411 8912 019	0411 7712 019
	RS 1. 20/12	20	13/16"	5.3 (M5)	6.8+	5.0	0.5	0411 8912 020	0411 7712 020
	RS 1. 21/12	21	13/16"	5.3 (M5)	6.8+	5.0	0.5	0411 8912 021	0411 7712 021
RS 1. 22/12	22	7/8"	5.3 (M5)	6.8+	5.0	0.5	0411 8912 022	0411 7712 022	
15	RS 1. 6/15	6	1/4"	6.4 (M6)	9.7+	6.0	0.6	0411 8915 006	0411 7715 006
	RS 1. 8/15	8	5/16"	6.4 (M6)	9.7+	6.0	0.6	0411 8915 008	0411 7715 008
	RS 1. 10/15	10	3/8"	6.4 (M6)	9.7+	6.0	0.6	0411 8915 010	0411 7715 010
	RS 1. 12/15	12	1/2"	6.4 (M6)	9.7+	6.0	0.6	0411 8915 012	0411 7715 012
	RS 1. 13/15	13	1/2"	6.4 (M6)	9.7+	6.0	0.6	0411 8915 013	0411 7715 013
	RS 1. 14/15	14	9/16"	6.4 (M6)	9.7+	6.0	0.8	0411 8915 014	0411 7715 014
	RS 1. 15/15	15	5/8"	6.4 (M6)	9.7+	6.0	0.8	0411 8915 015	0411 7715 015
	RS 1. 16/15	16	5/8"	6.4 (M6)	9.7+	6.0	0.8	0411 8915 016	0411 7715 016
	RS 1. 18/15	18	3/4"	6.4 (M6)	9.7+	6.0	0.8	0411 8915 018	0411 7715 018
	RS 1. 19/15	19	3/4"	6.4 (M6)	9.7+	6.0	0.8	0411 8915 019	0411 7715 019
	RS 1. 20/15	20	13/16"	6.4 (M6)	9.7+	6.0	0.8	0411 8915 020	0411 7715 020
	RS 1. 21/15	21	13/16"	6.4 (M6)	9.7+	6.0	0.8	0411 8915 021	0411 7715 021
	RS 1. 22/15	22	7/8"	6.4 (M6)	9.7+	6.0	0.8	0411 8915 022	0411 7715 022
	RS 1. 23/15	23	7/8"	6.4 (M6)	9.7+	6.0	0.8	0411 8915 023	0411 7715 023
	RS 1. 25/15	25	1"	6.4 (M6)	9.7+	6.0	0.8	0411 8915 025	0411 7715 025
	RS 1. 26/15	26	11/16"	6.4 (M6)	9.7+	6.0	0.8	0411 8915 026	0411 7715 026
	RS 1. 28/15	28	11/8"	6.4 (M6)	9.7+	6.0	0.8	0411 8915 028	0411 7715 028
	RS 1. 30/15	30	13/16"	6.4 (M6)	9.7+	6.0	0.8	0411 8915 030	0411 7715 030
RS 1. 32/15	32	11/4"	6.4 (M6)	9.7+	6.0	0.8	0411 8915 032	0411 7715 032	
RS 1. 34/15	34	15/16"	6.4 (M6)	9.7+	6.0	0.8	0411 8915 034	0411 7715 034	
RS 1. 35/15	35	13/8"	6.4 (M6)	9.7+	6.0	0.8	0411 8915 035	0411 7715 035	
20	RS 1. 10/20	10	3/8"	8.4 (M8)	12.5+	8.5	0.8	0411 8920 010	0411 7720 010
	RS 1. 12/20	12	1/2"	8.4 (M8)	12.5+	8.5	0.8	0411 8920 012	0411 7720 012
	RS 1. 13/20	13	1/2"	8.4 (M8)	12.5+	8.5	0.8	0411 8920 013	0411 7720 013
	RS 1. 14/20	14	9/16"	8.4 (M8)	12.5+	8.5	0.8	0411 8920 014	0411 7720 014
	RS 1. 15/20	15	5/8"	8.4 (M8)	12.5+	8.5	0.8	0411 8920 015	0411 7720 015
	RS 1. 16/20	16	5/8"	8.4 (M8)	12.5+	8.5	0.8	0411 8920 016	0411 7720 016
	RS 1. 18/20	18	3/4"	8.4 (M8)	12.5+	8.5	0.8	0411 8920 018	0411 7720 018
	RS 1. 19/20	19	3/4"	8.4 (M8)	12.5+	8.5	0.8	0411 8920 019	0411 7720 019
	RS 1. 20/20	20	13/16"	8.4 (M8)	12.5+	8.5	0.8	0411 8920 020	0411 7720 020
	RS 1. 22/20	22	7/8"	8.4 (M8)	12.5+	8.5	0.8	0411 8920 022	0411 7720 022
	RS 1. 23/20	23	7/8"	8.4 (M8)	12.5+	8.5	0.8	0411 8920 023	0411 7720 023
	RS 1. 24/20	24	15/16"	8.4 (M8)	12.5+	8.5	0.8	0411 8920 024	0411 7720 024
	RS 1. 25/20	25	1"	8.4 (M8)	12.5+	8.5	0.8	0411 8920 025	0411 7720 025
	RS 1. 28/20	28	11/8"	8.4 (M8)	12.5+	8.5	0.8	0411 8920 028	0411 7720 028
	RS 1. 30/20	30	13/16"	8.4 (M8)	12.5+	8.5	1.0	0411 8920 030	0411 7720 030
	RS 1. 32/20	32	11/4"	8.4 (M8)	12.5+	8.5	1.0	0411 8920 032	0411 7720 032
	RS 1. 34/20	34	15/16"	8.4 (M8)	12.5+	8.5	1.0	0411 8920 034	0411 7720 034
	RS 1. 35/20	35	13/8"	8.4 (M8)	12.5+	8.5	1.0	0411 8920 035	0411 7720 035
	RS 1. 36/20	36	17/16"	8.4 (M8)	12.5+	8.5	1.0	0411 8920 036	0411 7720 036
	RS 1. 38/20	38	11/2"	8.4 (M8)	12.5+	8.5	1.0	0411 8920 038	0411 7720 038
RS 1. 40/20	40	19/16"	8.4 (M8)	12.5+	8.5	1.0	0411 8920 040	0411 7720 040	

Band width 9 mm and 25 mm available as standard

Additional diameters available on request

Alternative rubber profiles (e.g. silicone) available on request

RS 2



NORMAFIX® RS 2									
Band width	Designation	Clamping ranges		d	h1 ² ~	l	s	W1 Product No.	W5 Product No.
		in mm	in inches						
12	RS 2. 6/12	6	1/4"	5.3 (M5)	6.8+	5.0	0.5	0412 8912 006	0412 7712 006
	RS 2. 8/12	8	5/16"	5.3 (M5)	6.8+	5.0	0.5	0412 8912 008	0412 7712 008
	RS 2. 10/12	10	3/8"	5.3 (M5)	6.8+	5.0	0.5	0412 8912 010	0412 7712 010
	RS 2. 12/12	12	1/2"	5.3 (M5)	6.8+	5.0	0.5	0412 8912 012	0412 7712 012
	RS 2. 13/12	13	1/2"	5.3 (M5)	6.8+	5.0	0.5	0412 8912 013	0412 7712 013
	RS 2. 14/12	14	9/16"	5.3 (M5)	6.8+	5.0	0.5	0412 8912 014	0412 7712 014
	RS 2. 15/12	15	5/8"	5.3 (M5)	6.8+	5.0	0.5	0412 8912 015	0412 7712 015
	RS 2. 16/12	16	5/8"	5.3 (M5)	6.8+	5.0	0.5	0412 8912 016	0412 7712 016
	RS 2. 18/12	18	3/4"	5.3 (M5)	6.8+	5.0	0.5	0412 8912 018	0412 7712 018
	RS 2. 19/12	19	3/4"	5.3 (M5)	6.8+	5.0	0.5	0412 8912 019	0412 7712 019
	RS 2. 20/12	20	13/16"	5.3 (M5)	6.8+	5.0	0.5	0412 8912 020	0412 7712 020
	RS 2. 21/12	21	13/16"	5.3 (M5)	6.8+	5.0	0.5	0412 8912 021	0412 7712 021
RS 2. 22/12	22	7/8"	5.3 (M5)	6.8+	5.0	0.5	0412 8912 022	0412 7712 022	
15	RS 2. 6/15	6	1/4"	6.4 (M6)	9.7+	6.0	0.6	0412 8915 006	0412 7715 006
	RS 2. 8/15	8	5/16"	6.4 (M6)	9.7+	6.0	0.6	0412 8915 008	0412 7715 008
	RS 2. 10/15	10	3/8"	6.4 (M6)	9.7+	6.0	0.6	0412 8915 010	0412 7715 010
	RS 2. 12/15	12	1/2"	6.4 (M6)	9.7+	6.0	0.8	0412 8915 012	0412 7715 012
	RS 2. 13/15	13	1/2"	6.4 (M6)	9.7+	6.0	0.8	0412 8915 013	0412 7715 013
	RS 2. 14/15	14	9/16"	6.4 (M6)	9.7+	6.0	0.8	0412 8915 014	0412 7715 014
	RS 2. 15/15	15	5/8"	6.4 (M6)	9.7+	6.0	0.8	0412 8915 015	0412 7715 015
	RS 2. 16/15	16	5/8"	6.4 (M6)	9.7+	6.0	0.8	0412 8915 016	0412 7715 016
	RS 2. 18/15	18	3/4"	6.4 (M6)	9.7+	6.0	0.8	0412 8915 018	0412 7715 018
	RS 2. 19/15	19	3/4"	6.4 (M6)	9.7+	6.0	0.8	0412 8915 019	0412 7715 019
	RS 2. 20/15	20	13/16"	6.4 (M6)	9.7+	6.0	0.8	0412 8915 020	0412 7715 020
	RS 2. 21/15	21	13/16"	6.4 (M6)	9.7+	6.0	0.8	0412 8915 021	0412 7715 021
	RS 2. 22/15	22	7/8"	6.4 (M6)	9.7+	6.0	0.8	0412 8915 022	0412 7715 022
	RS 2. 23/15	23	7/8"	6.4 (M6)	9.7+	6.0	0.8	0412 8915 023	0412 7715 023
	RS 2. 25/15	25	1"	6.4 (M6)	9.7+	6.0	0.8	0412 8915 025	0412 7715 025
	RS 2. 26/15	26	11/16"	6.4 (M6)	9.7+	6.0	0.8	0412 8915 026	0412 7715 026
	RS 2. 28/15	28	11/8"	6.4 (M6)	9.7+	6.0	0.8	0412 8915 028	0412 7715 028
	RS 2. 30/15	30	13/16"	6.4 (M6)	9.7+	6.0	0.8	0412 8915 030	0412 7715 030
RS 2. 32/15	32	11/4"	6.4 (M6)	9.7+	6.0	0.8	0412 8915 032	0412 7715 032	
RS 2. 34/15	34	15/16"	6.4 (M6)	9.7+	6.0	0.8	0412 8915 034	0412 7715 034	
RS 2. 35/15	35	13/8"	6.4 (M6)	9.7+	6.0	0.8	0412 8915 035	0412 7715 035	
20	RS 2. 10/20	10	3/8"	8.4 (M8)	12.5+	8.5	0.8	0412 8920 010	0412 7720 010
	RS 2. 12/20	12	1/2"	8.4 (M8)	12.5+	8.5	0.8	0412 8920 012	0412 7720 012
	RS 2. 13/20	13	1/2"	8.4 (M8)	12.5+	8.5	0.8	0412 8920 013	0412 7720 013
	RS 2. 14/20	14	9/16"	8.4 (M8)	12.5+	8.5	0.8	0412 8920 014	0412 7720 014
	RS 2. 15/20	15	5/8"	8.4 (M8)	12.5+	8.5	0.8	0412 8920 015	0412 7720 015
	RS 2. 16/20	16	5/8"	8.4 (M8)	12.5+	8.5	0.8	0412 8920 016	0412 7720 016
	RS 2. 18/20	18	3/4"	8.4 (M8)	12.5+	8.5	0.8	0412 8920 018	0412 7720 018
	RS 2. 19/20	19	3/4"	8.4 (M8)	12.5+	8.5	0.8	0412 8920 019	0412 7720 019
	RS 2. 20/20	20	13/16"	8.4 (M8)	12.5+	8.5	0.8	0412 8920 020	0412 7720 020
	RS 2. 22/20	22	7/8"	8.4 (M8)	12.5+	8.5	0.8	0412 8920 022	0412 7720 022
	RS 2. 23/20	23	7/8"	8.4 (M8)	12.5+	8.5	0.8	0412 8920 023	0412 7720 023
	RS 2. 24/20	24	15/16"	8.4 (M8)	12.5+	8.5	0.8	0412 8920 024	0412 7720 024
	RS 2. 25/20	25	1"	8.4 (M8)	12.5+	8.5	0.8	0412 8920 025	0412 7720 025
	RS 2. 28/20	28	11/8"	8.4 (M8)	12.5+	8.5	1.0	0412 8920 028	0412 7720 028
	RS 2. 30/20	30	13/16"	8.4 (M8)	12.5+	8.5	1.0	0412 8920 030	0412 7720 030
	RS 2. 32/20	32	11/4"	8.4 (M8)	12.5+	8.5	1.0	0412 8920 032	0412 7720 032
	RS 2. 34/20	34	15/16"	8.4 (M8)	12.5+	8.5	1.0	0412 8920 034	0412 7720 034
	RS 2. 35/20	35	13/8"	8.4 (M8)	12.5+	8.5	1.0	0412 8920 035	0412 7720 035
RS 2. 36/20	36	17/16"	8.4 (M8)	12.5+	8.5	1.0	0412 8920 036	0412 7720 036	
RS 2. 38/20	38	11/2"	8.4 (M8)	12.5+	8.5	1.0	0412 8920 038	0412 7720 038	
RS 2. 40/20	40	19/16"	8.4 (M8)	12.5+	8.5	1.0	0412 8920 040	0412 7720 040	

Band width 9 mm and 25 mm available as standard
 Additional diameters available on request
 Alternative rubber profiles (e.g. silicone) available on request

NORMAFIX®

RSV 1

The **NORMAFIX®** RSV 1 can be pre-positioned on the hose. The locking device keeps the RSV 1 safely in place if it needs to be stocked or transported prior to its final assembly.



Available in band widths of 15 and 20 mm, in the same dimensions as our RS 1. This system can only be fixed by using a special tool.

Advantages at a glance

- Safe pre-assembly on the hose
- No unintentional opening of the clamp during handling or transportation

Materials

W1, W3, W4, W5



Refer to page 198.

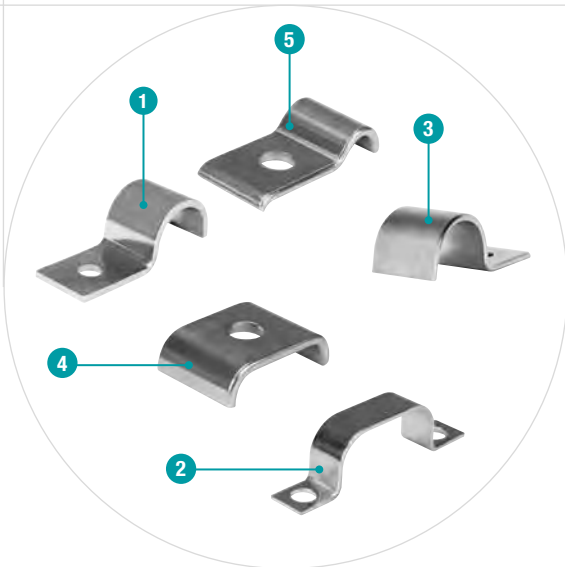

- 1 Fixing clips (BSL Type 510 / DIN 72571)
- 2 Fixing clips (BSL Type 512 / DIN 72573)
- 3 Fixing clips Standard range (BSN Type 520)
- 4 Fixing clips (BSS Type 532)
- 5 Fixing clip (RS Type 540 / DIN 1596)

NEW!

Fixing clips – NEW!

NORMAFIX® BS fixing clips enable pipes, cables and cable protection pipes to be attached to structures quickly and easily. They are suitable for all industrial applications which require a low-priced yet reliable attachment solution.

Advantages at a glance

- Sturdy band design and precise fit
- Components are retained securely and with ease
- Band width from 4 to 61 mm depending on the version
- Material thickness from 1 to 4 mm depending on the version
- Multiple versions for different applications

Materials

W1	W2	W3	W4	W5
x				

BSL TYPE 510 FOR 1 LINE

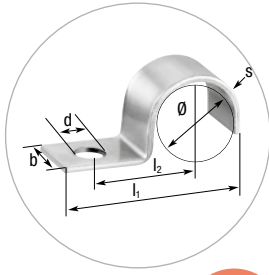

NEW!

NORMAFIX® BSL TYPE 510 FOR 1 LINE (In accordance with DIN 72571)

Width b	Designation	Clamping ranges		I1	I2	Bore hole in mm d	Mat. Thickness in mm s	W1 Product No.
		in mm	in inches					
10	BSL 510 1 x 4	4	3/16"	18	9	4.8	1	0510 8980 104
	BSL 510 1 x 5	5	3/16"	18.5	9	4.8	1	0510 8980 105
	BSL 510 1 x 6	6	1/4"	20	10	4.8	1	0510 8980 106
	BSL 510 1 x 7	7	1/4"	20.5	10	4.8	1	0510 8980 107
	BSL 510 1 x 8	8	5/16"	22	11	4.8	1	0510 8980 108
	BSL 510 1 x 9	9	3/8"	22.5	11	4.8	1	0510 8980 109
12	BSL 510 1 x 10	10	3/8"	23	11	4.8	1	0510 8980 110
	BSL 510 1 x 11	11	7/16"	30	15	5.8	1.5	0510 8980 111
	BSL 510 1 x 12	12	1/2"	30.5	16	5.8	1.5	0510 8980 112
	BSL 510 1 x 15	15	9/16"	34	18	5.8	1.5	0510 8980 115
	BSL 510 1 x 16	16	5/8"	35	18	5.8	1.5	0510 8980 116
	BSL 510 1 x 18	18	11/16"	35.5	18	7	1.5	0510 8980 118
	BSL 510 1 x 20	20	13/16"	37.5	19	7	1.5	0510 8980 120
	BSL 510 1 x 22	22	7/8"	39.5	20	7	1.5	0510 8980 122
BSL 510 1 x 24	24	15/16"	41.5	21	7	1.5	0510 8980 124	

BSL TYPE 510 FOR 2 LINES

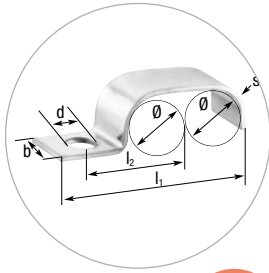

NEW!

NORMAFIX® BSL TYPE 510 FOR 2 LINES (In accordance with DIN 72571)

Width b	Designation	Clamping ranges		I1	I2	Bore hole in mm d	Mat. Thickness in mm s	W1 Product No.
		in mm	in inches					
10	BSL 510 2 x 4	4	3/16"	22.5	11	4.8	1	0510 8980 204
	BSL 510 2 x 5	5	3/16"	24	11.5	4.8	1	0510 8980 205
	BSL 510 2 x 6	6	1/4"	26.5	13	4.8	1	0510 8980 206
	BSL 510 2 x 7	7	1/4"	28	13.5	4.8	1	0510 8980 207
	BSL 510 2 x 8	8	5/16"	30.5	15	4.8	1	0510 8980 208
	BSL 510 2 x 10	10	3/8"	33.5	16	4.8	1	0510 8980 210
12	BSL 510 2 x 12	12	1/2"	43	22	5.8	1.5	0510 8980 212
	BSL 510 2 x 15	15	9/16"	49	25.3	5.8	1.5	0510 8980 215

BSL TYPE 512 FOR 1 LINE

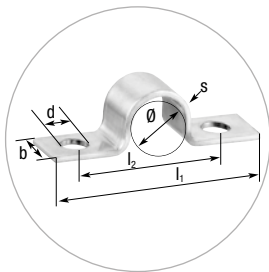

NEW!

NORMAFIX® BSL TYPE 512 FOR 1 LINE (In accordance with DIN 72573)

Width b	Designation	Clamping ranges		I1	I2	Bore hole in mm d	Mat. Thickness in mm s	W1 Product No.
		in mm	in inches					
10	BSL 512 1 x 4	4	3/16"	29	17	4.8	1	0512 8980 104
	BSL 512 1 x 5	5	3/16"	30	18	4.8	1	0512 8980 105
	BSL 512 1 x 6	6	1/4"	32	20	4.8	1	0512 8980 106
	BSL 512 1 x 7	7	1/4"	32	20	4.8	1	0512 8980 107
	BSL 512 1 x 8	8	5/16"	34	22	4.8	1	0512 8980 108
	BSL 512 1 x 10	10	3/8"	34	22	4.8	1	0512 8980 110
12	BSL 512 1 x 12	12	1/2"	46	32	5.8	1.5	0512 8980 112
	BSL 512 1 x 15	15	9/16"	50	36	5.8	1.5	0512 8980 115
	BSL 512 1 x 18	18	11/16"	50	36	7	1.5	0512 8980 118
	BSL 512 1 x 20	20	13/16"	52	38	7	1.5	0512 8980 120
	BSL 512 1 x 22	22	7/8"	54	40	7	1.5	0512 8980 122

BSL TYPE 512 FOR 2 LINES

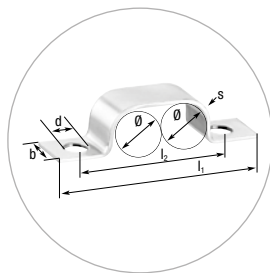

NEW!

NORMAFIX® BSL TYPE 512 FOR 2 LINES (In accordance with DIN 72573)								
Width b	Designation	Clamping ranges		I1	I2	Bore hole in mm d	Mat. Thickness in mm s	W1 Product No.
		in mm	in inches					
10	BSL 512 2 x 4	4	3/16"	33	21	4.8	1	0512 8980 204
	BSL 512 2 x 5	5	3/16"	35	23	4.8	1	0512 8980 205
	BSL 512 2 x 6	6	1/4"	38	26	4.8	1	0512 8980 206
	BSL 512 2 x 7	7	1/4"	39	27	4.8	1	0512 8980 207
	BSL 512 2 x 8	8	5/16"	42	30	4.8	1	0512 8980 208
	BSL 512 2 x 10	10	3/8"	44	32	4.8	1	0512 8980 210
12	BSL 512 2 x 12	12	1/2"	58	44	5.8	1.5	0512 8980 212
	BSL 512 2 x 15	15	9/16"	66	52	5.8	1.5	0512 8980 215
	BSL 512 2 x 18	18	11/16"	69	55	7	1.5	0512 8980 218
	BSL 512 2 x 20	20	13/16"	73	59	7	1.5	0512 8980 220
	BSL 512 2 x 22	22	7/8"	77	63	7	1.5	0512 8980 222

BSL TYPE 512 FOR 3 LINES

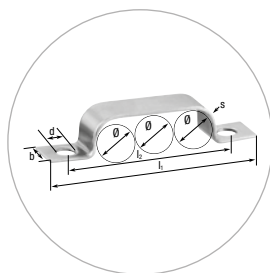

NEW!

NORMAFIX® BSL TYPE 512 FOR 3 LINES (In accordance with DIN 72573)								
Width b	Designation	Clamping ranges		I1	I2	Bore hole in mm d	Mat. Thickness in mm s	W1 Product No.
		in mm	in inches					
10	BSL 512 3 x 4	4	3/16"	39	27	4.8	1	0512 8980 304
	BSL 512 3 x 5	5	3/16"	41	29	4.8	1	0512 8980 305
	BSL 512 3 x 6	6	1/4"	45	33	4.8	1	0512 8980 306
	BSL 512 3 x 7	7	1/4"	47	35	4.8	1	0512 8980 307
	BSL 512 3 x 8	8	5/16"	51	39	4.8	1	0512 8980 308
	BSL 512 3 x 10	10	3/8"	55	43	4.8	1	0512 8980 310
12	BSL 512 3 x 12	12	1/2"	71	57	5.8	1.5	0512 8980 312
	BSL 512 3 x 15	15	9/16"	81	67	5.8	1.5	0512 8980 315
	BSL 512 3 x 18	18	11/16"	87	73	7	1.5	0512 8980 318
	BSL 512 3 x 20	20	13/16"	93	79	7	1.5	0512 8980 320
	BSL 512 3 x 22	22	7/8"	99	85	7	1.5	0512 8980 322

BSL TYPE 512 FOR 4 LINES

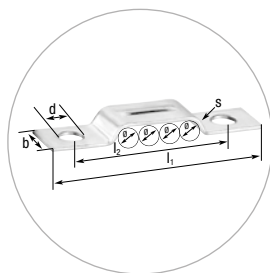

NEW!

NORMAFIX® BSL TYPE 512 FOR 4 LINES (In accordance with DIN 72573)								
Width b	Designation	Clamping ranges		I1	I2	Bore hole in mm d	Mat. Thickness in mm s	W1 Product No.
		in mm	in inches					
10	BSL 512 4 x 4	4	3/16"	29	17	4.8	1	0512 8980 104
	BSL 512 4 x 5	5	3/16"	30	18	4.8	1	0512 8980 105
	BSL 512 4 x 6	6	1/4"	32	20	4.8	1	0512 8980 106
	BSL 512 4 x 7	7	1/4"	32	20	4.8	1	0512 8980 107
	BSL 512 4 x 8	8	5/16"	34	22	4.8	1	0512 8980 108
	BSL 512 4 x 10	10	3/8"	34	22	4.8	1	0512 8980 110
12	BSL 512 4 x 12	12	1/2"	46	32	5.8	1.5	0512 8980 112
	BSL 512 4 x 15	15	9/16"	50	36	5.8	1.5	0512 8980 115
	BSL 512 4 x 18	18	11/16"	50	36	7	1.5	0512 8980 118
	BSL 512 4 x 20	20	13/16"	52	38	7	1.5	0512 8980 120
	BSL 512 4 x 22	22	7/8"	54	40	7	1.5	0512 8980 122

NORMAFIX®

NEW

BSL TYPE 512 FOR 5 LINES

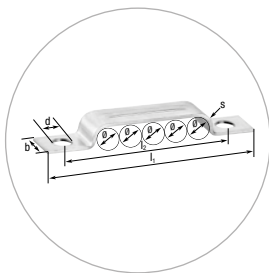

NEW!

NORMAFIX® BSL TYPE 512 FOR 5 LINES (In accordance with DIN 72573)

Width b	Designation	Clamping ranges		l1	l2	Bore hole in mm d	Mat. Thickness in mm s	W1 Product No.
		in mm	in inches					
10	BSL 512 5 x 4	4	3/16"	48	36	4.8	1	0512 8980 504
	BSL 512 5 x 5	5	3/16"	53	41	4.8	1	0512 8980 505
	BSL 512 5 x 6	6	1/4"	57	45	4.8	1	0512 8980 506
	BSL 512 5 x 7	7	1/4"	63	51	4.8	1	0512 8980 507
	BSL 512 5 x 8	8	5/16"	68	56	4.8	1	0512 8980 508
	BSL 512 5 x 10	10	3/8"	77	65	4.8	1	0512 8980 510
12	BSL 512 5 x 12	12	1/2"	95	81	5.8	1.5	0512 8980 512

BSL TYPE 512 FOR 6 LINES

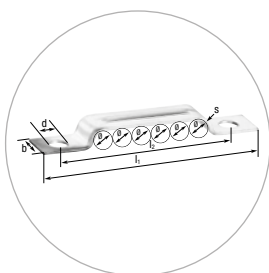

NEW!

NORMAFIX® BSL TYPE 512 FOR 6 LINES (In accordance with DIN 72573)

Width b	Designation	Clamping ranges		l1	l2	Bore hole in mm d	Mat. Thickness in mm s	W1 Product No.
		in mm	in inches					
10	BSL 512 6 x 4	4	3/16"	52	40	4.8	1	0512 8980 604
	BSL 512 6 x 5	5	3/16"	58	46	4.8	1	0512 8980 605
	BSL 512 6 x 6	6	1/4"	64	52	4.8	1	0512 8980 606
	BSL 512 6 x 7	7	1/4"	72	60	4.8	1	0512 8980 607
	BSL 512 6 x 8	8	5/16"	76	64	4.8	1	0512 8980 608
	BSL 512 6 x 10	10	3/8"	90	78	4.8	1	0512 8980 610

BSN TYPE 520 FOR 1 LINE

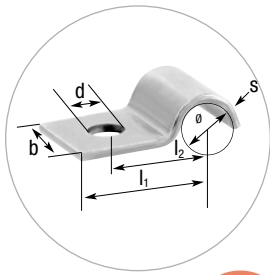

NEW!

NORMAFIX® BSN TYPE 520 FOR 1 LINE

Width b	Designation	Clamping ranges		l1	l2	Bore hole in mm d	Mat. Thickness in mm s	W1 Product No.
		in mm	in inches					
20	BSN 520 1 X 8	8	5/16"	26	16.5	7	2	0520 7000 008
	BSN 520 1 X 9	9	3/8"	26.5	17	7	2	0520 7000 009
	BSN 520 1 X 10	10	3/8"	26.5	17	7	2	0520 7000 010
	BSN 520 1 X 12	12	1/2"	28	18	7	2	0520 7000 012
	BSN 520 1 X 13	13	1/2"	28.5	19	7	2	0520 7000 013
	BSN 520 1 X 15	15	9/16"	28.5	19	7	2	0520 7000 015
	BSN 520 1 X 18	18	11/16"	30	21.5	7	2	0520 7000 018
	BSN 520 1 X 19	19	3/4"	30.5	22	7	2	0520 7000 019
	BSN 520 1 X 20	20	13/16"	32	22.5	7	2	0520 7000 020
	BSN 520 1 X 22	22	7/8"	35	23.5	7	2	0520 7000 022
20	BSN 520 1 X 23	23	15/16"	35.5	25.5	7	2	0520 7000 023
	BSN 520 1 X 27	27	1 1/16"	37.5	27.5	7	2	0520 7000 027

BSN TYPE 521 FOR 1 LINE

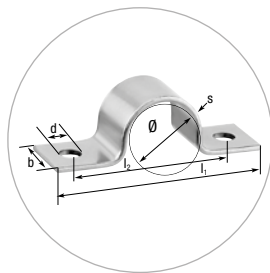

NEW!

NORMAFIX® BSN TYPE 521 FOR 1 LINE

Width b	Designation	Clamping ranges		l1	l2	Bore hole in mm d	Mat. Thickness in mm s	W1 Product No.
		in mm	in inches					
20	BSN 521 1 X 7	7	1/4"	44	28	7	2	0521 7000 007
	BSN 521 1 X 9	9	3/8"	48	32	7	2	0521 7000 009
	BSN 521 1 X 10	10	3/8"	49	33	7	2	0521 7000 010
	BSN 521 1 X 11	11	7/16"	50	34	7	2	0521 7000 011
	BSN 521 1 X 12	12	1/2"	51	35	7	2	0521 7000 012
	BSN 521 1 X 13	13	1/2"	53	37	7	2	0521 7000 013
	BSN 521 1 X 15	15	9/16"	56	40	7	2	0521 7000 015
	BSN 521 1 X 18	18	11/16"	59	43	7	2	0521 7000 018
	BSN 521 1 X 19	19	3/4"	60.5	44.5	7	2	0521 7000 019
	BSN 521 1 X 20	20	13/16"	65	49	7	2	0521 7000 020
20	BSN 521 1 X 22	22	7/8"	67	51	7	2	0521 7000 022
	BSN 521 1 X 23	23	15/16"	68	52	7	2	0521 7000 023
	BSN 521 1 X 26	27	1"	68	52	7	2	0521 7000 027

BSN TYPE 522 FOR 2 LINES

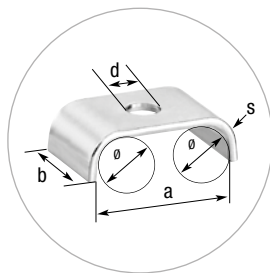

NEW!

NORMAFIX® BSN TYPE 522 FOR 2 LINES

Width b	Designation	Clamping ranges		a	Bore hole in mm d	Mat. Thickness in mm s	W1 Product No.
		in mm	in inches				
20	BSN 522 2 X 9	9	3/8"	26	7	2	0522 7000 009
	BSN 522 2 X 10	10	3/8"	28	7	2	0522 7000 010
	BSN 522 2 X 12	12	1/2"	32	7	2	0522 7000 012
	BSN 522 2 X 13	13	1/2"	34	7	2	0522 7000 013
	BSN 522 2 X 15	15	9/16"	38	7	2	0522 7000 015
	BSN 522 2 X 18	18	11/16"	44	7	2	0522 7000 018
	BSN 522 2 X 19	19	3/4"	46	7	2	0522 7000 019
	BSN 522 2 X 20	20	13/16"	48	7	2	0522 7000 020
	BSN 522 2 X 22	22	7/8"	52	7	2	0522 7000 022

BSS TYPE 530 FOR 1 LINE

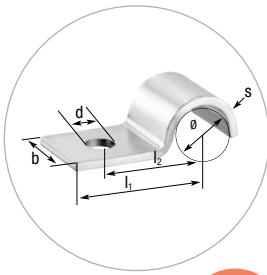

NEW!

NORMAFIX® BSS TYPE 530 FOR 1 LINE

Width b	Designation	Clamping ranges		I1	I2	Bore hole in mm d	Mat. Thickness in mm s	W1 Product No.
		in mm	in inches					
25	BSS 530 1 X 10	10	3/8"	28	18.5	9	3	0530 7000 010
	BSS 530 1 X 12	12	1/2"	39	24	9	3	0530 7000 012
	BSS 530 1 X 13	13	1/2"	39.5	24.5	9	3	0530 7000 013
	BSS 530 1 X 15	15	9/16"	40.5	25.5	9	3	0530 7000 015
	BSS 530 1 X 18	18	11/16"	42	28	9	3	0530 7000 018
	BSS 530 1 X 19	19	3/4"	43.5	29	9	3	0530 7000 019
	BSS 530 1 X 20	20	13/16"	44	29.5	9	3	0530 7000 020
	BSS 530 1 X 22	22	7/8"	44	29.5	9	3	0530 7000 022
	BSS 530 1 X 23	23	15/16"	44.5	30	9	3	0530 7000 023
	BSS 530 1 X 26	26	1"	52	36	9	3	0530 7000 026
	BSS 530 1 X 28.5	28.5	1 1/8"	52	36	9	3	0530 7000 028
	BSS 530 1 X 31	31	1 1/4"	56	40	9	3	0530 7000 031
	BSS 530 1 X 36	36	1 7/16"	58	41.5	9	3	0530 7000 036
	BSS 530 1 X 39	39	1 9/16"	58.5	42	9	3	0530 7000 039
	BSS 530 1 X 43	43	1 11/16"	70	50	9	3	0530 7000 043

BSS TYPE 531 FOR 1 LINE

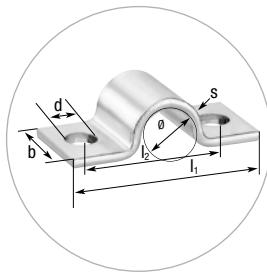

NEW!

NORMAFIX® BSS TYPE 531 FOR 1 LINE

Width b	Designation	Clamping ranges		I1	I2	Bore hole in mm d	Mat. Thickness in mm s	W1 Product No.
		in mm	in inches					
25	BSS 531 1 X 10	10	3/8"	28	18.5	9	3	0531 7000 010
	BSS 531 1 X 12	12	1/2"	39	24	9	3	0531 7000 012
	BSS 531 1 X 13	13	1/2"	39.5	24.5	9	3	0531 7000 013
	BSS 531 1 X 15	15	9/16"	40.5	25.5	9	3	0531 7000 015
	BSS 531 1 X 18	18	11/16"	42	28	9	3	0531 7000 018
	BSS 531 1 X 19	19	3/4"	43.5	29	9	3	0531 7000 019
	BSS 531 1 X 20	20	13/16"	44	29.5	9	3	0531 7000 020
	BSS 531 1 X 22	22	7/8"	44	29.5	9	3	0531 7000 022
	BSS 531 1 X 23	23	15/16"	44.5	30	9	3	0531 7000 023
	BSS 531 1 X 26	26	1"	52	36	9	3	0531 7000 026
	BSS 531 1 X 28.5	28.5	1 1/8"	52	36	9	3	0531 7000 028
	BSS 531 1 X 31	31	1 1/4"	56	40	9	3	0531 7000 031
	BSS 531 1 X 36	36	1 7/16"	58	41.5	9	3	0531 7000 036
	BSS 531 1 X 39	39	1 9/16"	58.5	42	9	3	0531 7000 039
	BSS 531 1 X 43	43	1 11/16"	70	50	9	3	0531 7000 043

BSS TYPE 532 FOR 2 LINES

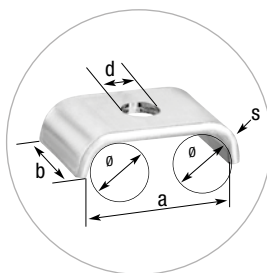

NEW!

NORMAFIX® BSS TYPE 532 FOR 2 LINES

Width b	Designation	Clamping ranges		a	Bore hole in mm d	Mat. Thickness in mm s	W1 Product No.
		in mm	in inches				
25	BSS 532 2 X 10	10	3/8"	30	9	3	0532 7000 010
	BSS 532 2 X 12	12	1/2"	34	9	3	0532 7000 012
	BSS 532 2 X 13	13	1/2"	36	9	3	0532 7000 013
	BSS 532 2 X 15	15	9/16"	40	9	3	0532 7000 015
	BSS 532 2 X 18	18	11/16"	46	9	3	0532 7000 018
	BSS 532 2 X 20	20	13/16"	50	9	3	0532 7000 020
	BSS 532 2 X 22	22	7/8"	54	9	3	0532 7000 022
	BSS 532 2 X 23	23	15/16"	56	9	3	0532 7000 023
	BSS 532 2 X 26	26	1"	62	9	3	0532 7000 026

BS TYPE 540 FOR 1 LINE

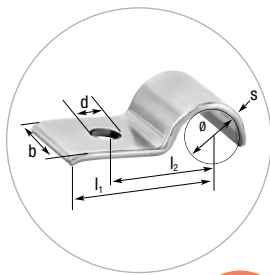

NEW!

NORMAFIX® BS TYPE 540 FOR 1 LINE (In accordance with DIN 1596)								
Width b	Designation	Clamping ranges		I1	I2	Bore hole in mm d	Mat. Thickness in mm s	W1 Product No.
		in mm	in inches					
16	BS 540 1 x 7	7	1/4"	26	14	6.6	2	0540 7000 007
	BS 540 1 x 9	9	3/8"	28	16	6.6	2	0540 7000 009
20	BS 540 1 x 13	13	1/2"	30	18	6.6	2	0540 7000 013
	BS 540 1 x 15.5	15.5	5/8"	32	20	6.6	2	0540 7000 015
	BS 540 1 x 19	19	3/4"	34	22	6.6	2	0540 7000 019
25	BS 540 1 x 23	23	15/16"	43	28	9	3	0540 7000 023
	BS 540 1 x 26	26	1"	44	29	9	3	0540 7000 026
	BS 540 1 x 28.5	28.5	1 1/8"	47	32	9	3	0540 7000 028
	BS 540 1 x 31	31	1 1/4"	47	32	9	3	0540 7000 031
	BS 540 1 x 33	33	1 5/16"	56	36	9	3	0540 7000 033
30	BS 540 1 x 36	36	1 7/16"	57	40	11	3	0540 7000 036
	BS 540 1 x 39	39	1 9/16"	59	42	11	3	0540 7000 039
	BS 540 1 x 43	43	1 11/16"	61	44	11	3	0540 7000 043
	BS 540 1 x 46	46	1 13/16"	62	45	11	3	0540 7000 046
40	BS 540 1 x 49	49	1 15/16"	67	48	14	4	0540 7000 049
	BS 540 1 x 52	52	2 1/16"	72	53	14	4	0540 7000 052
	BS 540 1 x 58	58	2 1/4"	74	55	14	4	0540 7000 058
	BS 540 1 x 61	61	2 3/8"	77	58	14	4	0540 7000 061

NORMAFIX®

NEW

BS TYPE 541 FOR 1 LINE

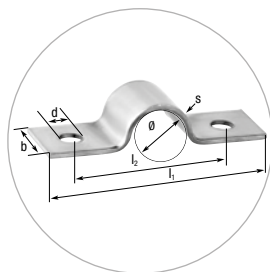

NEW!

NORMAFIX® BS TYPE 541 FOR 1 LINE (In accordance with DIN 1597)								
Width b	Designation	Clamping ranges		I1	I2	Bore hole in mm d	Mat. Thickness in mm s	W1 Product No.
		in mm	in inches					
16	BS 541 1 x 7	7	1/4"	44	28	5.5	1.5	0541 7000 007
	BS 541 1 x 9	9	3/8"	48	32	5.5	1.5	0541 7000 009
20	BS 541 1 x 13	13	1/2"	52	36	5.5	1.5	0541 7000 013
	BS 541 1 x 15.5	15.5	5/8"	56	40	5.5	1.5	0541 7000 015
	BS 541 1 x 19	19	3/4"	60	44	5.5	1.5	0541 7000 019
25	BS 541 1 x 23	23	15/16"	76	56	6.6	2	0541 7000 023
	BS 541 1 x 26	26	1"	78	58	6.6	2	0541 7000 026
	BS 541 1 x 28.5	28.5	1 1/8"	84	64	6.6	2	0541 7000 028
	BS 541 1 x 31	31	1 1/4"	84	64	6.6	2	0541 7000 031
	BS 541 1 x 33	33	1 5/16"	92	72	6.6	2	0541 7000 033
30	BS 541 1 x 36	36	1 7/16"	104	80	9	3	0541 7000 036
	BS 541 1 x 39	39	1 9/16"	108	84	9	3	0541 7000 039
	BS 541 1 x 43	43	1 11/16"	112	88	9	3	0541 7000 043
	BS 541 1 x 46	46	1 13/16"	114	90	9	3	0541 7000 046
40	BS 541 1 x 49	49	1 15/16"	118	90	11	3	0541 7000 049
	BS 541 1 x 52	52	2 1/16"	134	106	11	3	0541 7000 052
	BS 541 1 x 58	58	2 1/4"	138	110	11	3	0541 7000 058
	BS 541 1 x 61	61	2 3/8"	138	110	11	3	0541 7000 061



- 1 Bridge design to protect the wire in spiral hose
- 2 Low profile head to safe keep the cable ties cut edge



NORMAFIX® HVAC Clip – a flexible solution for fixing spiral hoses

In combination with our cable tie, the **NORMAFIX®** HVAC Clip makes it very easy to attach externally corrugated spiral hoses in HVAC (heating, ventilation, air conditioning) installations. It is a lightweight, flexible and economical alternative to metal spiral hose clamps. The patented shape and functionality of the **NORMAFIX®** HVAC Clip makes it possible to span the crossing of the hose spiral. Thanks to this special geometry,

the cable tie can grip the hose around its whole perimeter so that it is fixed safely. Suitable for cable ties with bandwidth 9 mm. The shape of our HVAC Clip and our cable ties match perfectly, forming a reliable system. This system works independently of the direction of the spiral on the hose. The HVAC Clip can be used for both clockwise and counter clockwise spiral hoses. One clip fits all.

Advantages at a glance

- Economical, lightweight and flexible alternative to spiral hose clamps
- Applicable for both clockwise and counter clockwise spiral hoses
- Simple installation by hand, no special tools required

Applications

- For any HVAC applications with spiral hoses
- Heating, ventilation, air conditioning
- Ventilation of greenhouses
- Clean room ventilation
- Welding fume exhaust

Material

Polyamide 6.6

Technical data & Ordering information

NORMAFIX® HVAC CLIP	
Description	Product No.
HVAC CLIP	0859 2066 001

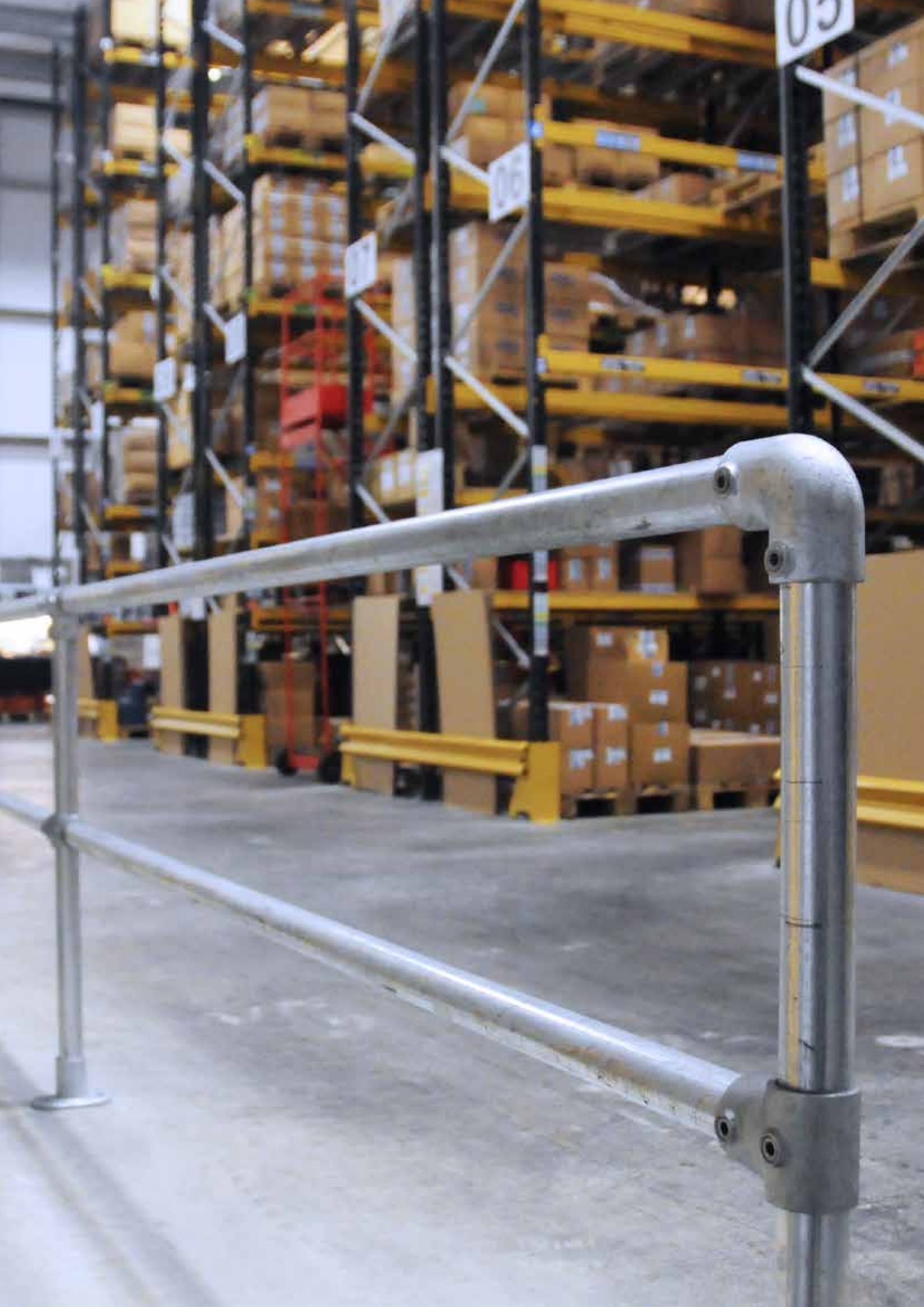

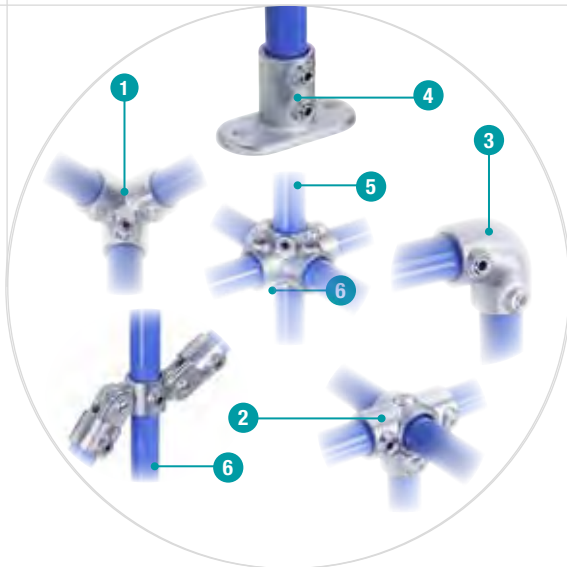

- 1 3 ways 90° elbow
- 2 Side outlet tee
- 3 90° elbow
- 4 Railing base flange
- 5 Four way cross
- 6 Double swivel combination

Tube clamp fittings for safety systems

Made of malleable galvanized iron to ensure strength, quality and conformity of production. **NORMAFIX®** Tube Clamp Fittings can be easily assembled on pipes in order to create safety systems.

Advantages at a glance

- Stainless steel screw
- Warranty up to 1500 N/m load
- No welding, so no fire permits required
- No threading, no bolting
- Can be assembled with a simple hexagonal key
- A versatile system that allows changes on site
- Can be painted

Applications

- Handrails
- Safety rails/Protective barriers
- Fall protections
- Other applications for safety work
- Fix railings
- Machinery guard
- Playgrounds

Material

Malleable galvanized iron

Sleeve joint

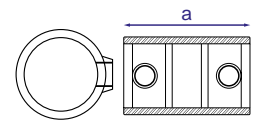

NORMAFIX® SLEEVE JOINT

Designation	Diameter in mm	a mm	Malleable galvanized iron Product No.
SLEEVE JOINT 26.9	26.9	76	0819 6301 027
SLEEVE JOINT 33.7	33.7	90	0819 6301 034
SLEEVE JOINT 42.4	42.4	100	0819 6301 042
SLEEVE JOINT 48.3	48.3	100	0819 6301 048
SLEEVE JOINT 60.3	60.3	120	0819 6301 060



Refer to page 199 and 200.

Expanding connector

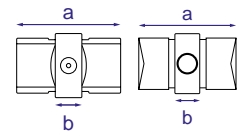
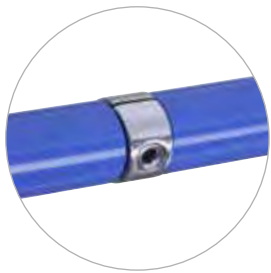

NORMAFIX® EXPANDING CONNECTOR

Designation	Diameter in mm	a mm	b mm	Malleable galvanized iron Product No.
EXPANDING CONNECTOR 33.7	33.7	78	20	0819 6302 034
EXPANDING CONNECTOR 42.4	42.4	78	20	0819 6302 042
EXPANDING CONNECTOR 48.3	48.3	78	20	0819 6302 048



Refer to page 199 and 200.

90° elbow

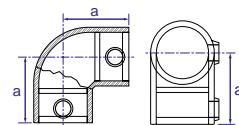

NORMAFIX® 90° ELBOW

Designation	Diameter in mm	a mm	Malleable galvanized iron Product No.
90° ELBOW 26.9	26.9	41	0819 6303 027
90° ELBOW 33.7	33.7	46	0819 6303 034
90° ELBOW 42.4	42.4	60	0819 6303 042
90° ELBOW 48.3	48.3	68	0819 6303 048
90° ELBOW 60.3	60.3	84	0819 6303 060



Refer to page 199 and 200.

Short T

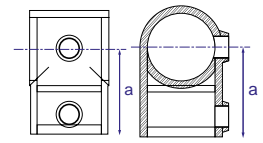

NORMAFIX® SHORT T

Designation	Diameter in mm	a mm	Malleable galvanized iron Product No.
SHORT T 26.9	26.9	41	0819 6304 027
SHORT T 33.7	33.7	46	0819 6304 034
SHORT T 42.4	42.4	60	0819 6304 042
SHORT T 48.3	48.3	68	0819 6304 048
SHORT T 60.3	60.3	84	0819 6304 060



Refer to page 199 and 200.

Long T

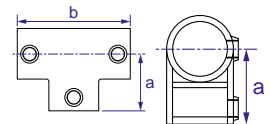

NORMAFIX® LONG T

Designation	Diameter in mm	a mm	b mm	Malleable galvanized iron Product No.
LONG T 26.9	26.9	41	82	0819 6305 027
LONG T 33.7	33.7	46	92	0819 6305 034
LONG T 42.4	42.4	60	120	0819 6305 042
LONG T 48.3	48.3	68	135	0819 6305 048
LONG T 60.3	60.3	84	168	0819 6305 060



Refer to page 199 and 200.

Wall flange

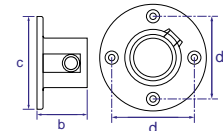

NORMAFIX® WALL FLANGE

Designation	Diameter in mm	b mm	c mm	d mm	Malleable galvanized iron Product No.
WALL FLANGE 26.9	26.9	42	83	59	0819 6306 027
WALL FLANGE 33.7	33.7	48	89	65	0819 6306 034
WALL FLANGE 42.4	42.4	51	102	76	0819 6306 042
WALL FLANGE 48.3	48.3	59	114	88.5	0819 6306 048
WALL FLANGE 60.3	60.3	64	128	97	0819 6306 060



Refer to page 199 and 200.

Railing base flange

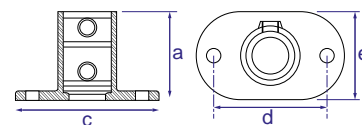

NORMAFIX® RAILING BASE FLANGE

Designation	Diameter in mm	a mm	c mm	d mm	e mm	Malleable galvanized iron Product No.
RAILING BASE FLANGE 26.9	26.9	60	105	76	52	0819 6307 027
RAILING BASE FLANGE 33.7	33.7	71	127	89	62	0819 6307 034
RAILING BASE FLANGE 42.4	42.4	84	139	101	72	0819 6307 042
RAILING BASE FLANGE 48.3	48.3	89	152	114	86	0819 6307 048
RAILING BASE FLANGE 60.3	60.3	104	165	127	96	0819 6307 060



Refer to page 199 and 200.

Handrail bracket

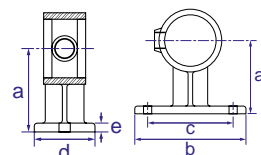

NORMAFIX® HANDRAIL BRACKET

Designation	Diameter in mm	a mm	b mm	c mm	d mm	e mm	Malleable galvanized iron Product No.
HANDRAIL BRACKET 26.9	26.9	54	77	57	44	7	0819 6308 027
HANDRAIL BRACKET 33.7	33.7	57	80	62	44	7	0819 6308 034
HANDRAIL BRACKET 42.4	42.4	62	102	82.5	45	7	0819 6308 042
HANDRAIL BRACKET 48.3	48.3	70	107	82.5	50	7	0819 6308 048



Refer to page 199 and 200.

3 ways 90° elbow

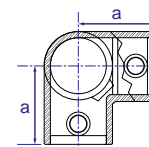

NORMAFIX® 3 WAYS 90° ELBOW

Designation	Diameter in mm	a mm	Malleable galvanized iron Product No.
3 WAYS 90° ELBOW 26.9	26.9	41	0819 6309 027
3 WAYS 90° ELBOW 33.7	33.7	48	0819 6309 034
3 WAYS 90° ELBOW 42.4	42.4	60	0819 6309 042
3 WAYS 90° ELBOW 48.3	48.3	68	0819 6309 048
3 WAYS 90° ELBOW 60.3	60.3	84	0819 6309 060



Refer to page 199 and 200.

Corner C/W through tube

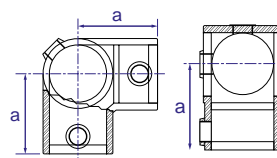

NORMAFIX® CORNER C/W THROUGH TUBE

Designation	Diameter in mm	a mm	Malleable galvanized iron Product No.
CORNER C/W THRO TUBE 26.9	26.9	41	0819 6310 027
CORNER C/W THRO TUBE 33.7	33.7	46	0819 6310 034
CORNER C/W THRO TUBE 42.4	42.4	60	0819 6310 042
CORNER C/W THRO TUBE 48.3	48.3	68	0819 6310 048
CORNER C/W THRO TUBE 60.3	60.3	84	0819 6310 060



Refer to page 199 and 200.

Two socket cross

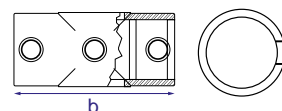

NORMAFIX® TWO SOCKET CROSS

Designation	Diameter in mm	a mm	Malleable galvanized iron Product No.
TWO SOCKET CROSS 26.9	26.9	82	0819 6311 027
TWO SOCKET CROSS 33.7	33.7	92	0819 6311 034
TWO SOCKET CROSS 42.4	42.4	120	0819 6311 042
TWO SOCKET CROSS 48.3	48.3	135	0819 6311 048
TWO SOCKET CROSS 60.3	60.3	168	0819 6311 060



Refer to page 199 and 200.

Side outlet tee

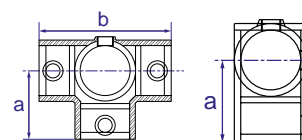

NORMAFIX® SIDE OUTLET TEE

Designation	Diameter in mm	a mm	b mm	Malleable galvanized iron Product No.
SIDE OUTLET TEE 26.9	26.9	41	82	0819 6312 027
SIDE OUTLET TEE 33.7	33.7	46	92	0819 6312 034
SIDE OUTLET TEE 42.4	42.4	60	120	0819 6312 042
SIDE OUTLET TEE 48.3	48.3	68	136	0819 6312 048
SIDE OUTLET TEE 60.3	60.3	84.5	169	0819 6312 060



Refer to page 199 and 200.

Four way cross and center

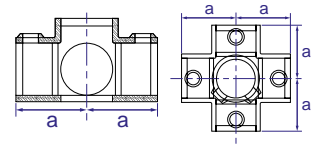

NORMAFIX® FOUR WAY CROSS AND CENTER

Designation	Diameter in mm	a mm	Malleable galvanized iron Product No.
FOUR WAY CROSS AND CENTER 26.9	26.9	41	0819 6313 027
FOUR WAY CROSS AND CENTER 33.7	33.7	46	0819 6313 034
FOUR WAY CROSS AND CENTER 42.4	42.4	60	0819 6313 044
FOUR WAY CROSS AND CENTER 48.3	48.3	68	0319 6313 048



Refer to page 199 and 200.

Fixing pad

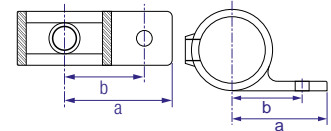

NORMAFIX® FIXING PAD

Designation	Diameter in mm	a mm	b mm	Malleable galvanized iron Product No.
FIXING PAD 33.7	33.7	60	43	0819 6314 034
FIXING PAD 42.4	42.4	66	48	0819 6314 042
FIXING PAD 48.3	48.3	70	52	0819 6314 048



Refer to page 199 and 200.

Double wall coupler

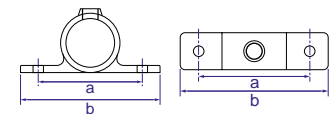

NORMAFIX® DOUBLE WALL COUPLER

Designation	Diameter in mm	a mm	b mm	Malleable galvanized iron Product No.
DOUBLE WALL COUPLER 33.7	33.7	86	120	0819 6315 034
DOUBLE WALL COUPLER 42.4	42.4	95	130	0819 6315 042
DOUBLE WALL COUPLER 48.3	48.3	104	140	0819 6315 048



Refer to page 199 and 200.

Male swivel

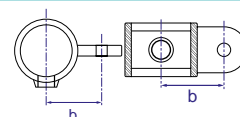

NORMAFIX® MALE SWIVEL

Designation	Diameter in mm	b mm	Malleable galvanized iron Product No.
MALE SWIVEL 33.7	33.7	43.5	0819 6316 034
MALE SWIVEL 42.4	42.4	48	0819 6316 042
MALE SWIVEL 48.3	48.3	53	0819 6316 048
MALE SWIVEL 60.3	60.3	60	0819 6316 060



Refer to page 199 and 200.

NORMAFIX®

Female swivel

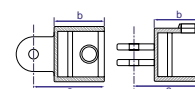

NORMAFIX® FEMALE SWIVEL

Designation	Diameter in mm	a mm	b mm	Malleable galvanized iron Product No.
FEMALE SWIVEL 33.7	33.7	61	38	0819 6317 034
FEMALE SWIVEL 42.4	42.4	69	46	0819 6317 042
FEMALE SWIVEL 48.3	48.3	77	55	0819 6317 048
FEMALE SWIVEL 60.3	60.3	89	65	0819 6317 060



Refer to page 199 and 200.

Gate eye

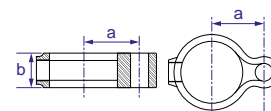

NORMAFIX® GATE EYE

Designation	Diameter in mm	a mm	b mm	Malleable galvanized iron Product No.
GATE EYE 33.7	33.7	33	25.5	0819 6318 034
GATE EYE 42.4	42.4	38	25	0819 6318 042
GATE EYE 48.3	48.3	41	25	0819 6318 048



Refer to page 199 and 200.

Gate hinge

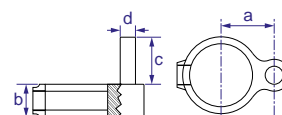

NORMAFIX® GATE HINGE

Designation	Diameter in mm	a mm	b mm	c mm	d mm	Malleable galvanized iron Product No.
GATE HINGE 33.7	33.7	33	25.5	38	12	0819 6319 034
GATE HINGE 42.4	42.4	38	25	38	12	0819 6319 042
GATE HINGE 48.3	48.3	25	25	38	12	0819 6319 048



Refer to page 199 and 200.

Double male swivel

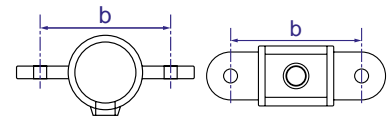

NORMAFIX® DOUBLE MALE SWIVEL

Designation	Diameter in mm	b mm	Malleable galvanized iron Product No.
DOUBLE MALE SWIVEL 33.7	33.7	84	0819 6320 034
DOUBLE MALE SWIVEL 42.4	42.4	95	0819 6320 042
DOUBLE MALE SWIVEL 48.3	48.3	105	0819 6320 048
DOUBLE MALE SWIVEL 60.3	60.3	124	0819 6320 060



Refer to page 199 and 200.

90° corner male swivel

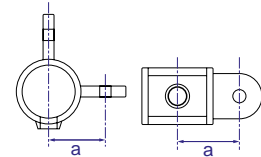

NORMAFIX® 90° CORNER MALE SWIVEL

Designation	Diameter in mm	a mm	Malleable galvanized iron Product No.
90° CORNER MALE SWIVEL 33.7	33.7	43.5	0819 6321 034
90° CORNER MALE SWIVEL 42.4	42.4	48	0819 6321 042
90° CORNER MALE SWIVEL 48.3	48.3	53	0819 6321 048
90° CORNER MALE SWIVEL 60.3	60.3	62	0819 6321 060



Refer to page 199 and 200.

90° Crossover

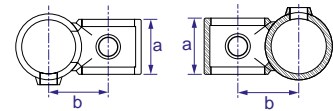

NORMAFIX® 90° CROSSOVER

Designation	Diameter in mm	a mm	b mm	Material: Malleable galvanized iron Product No.
90° CROSSOVER 26.9	26.9	31.5	38	0819 6322 027
90° CROSSOVER 33.7	33.7	38.5	41	0819 6322 034
90° CROSSOVER 42.4	42.4	46	49.5	0819 6322 042
90° CROSSOVER 48.3	48.3	51	55	0819 6322 048
90° CROSSOVER 60.3	60.3	61	67	0819 6322 060



Refer to page 199 and 200.

Single swivel combination

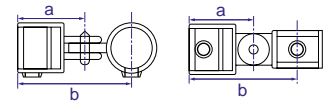

NORMAFIX® SINGLE SWIVEL COMBINATION

Designation	Diameter in mm	a mm	b mm	Malleable galvanized iron Product No.
SINGLE SWIVEL COMBINATION 26.9	26.9	61	106	0819 6323 027
SINGLE SWIVEL COMBINATION 33.7	33.7	61	104.5	0819 6323 034
SINGLE SWIVEL COMBINATION 42.4	42.4	69	117	0819 6323 042
SINGLE SWIVEL COMBINATION 48.3	48.3	77	130	0819 6323 048
SINGLE SWIVEL COMBINATION 60.3	60.3	89	152	0819 6323 060



Refer to page 199 and 200.

Base swivel combination

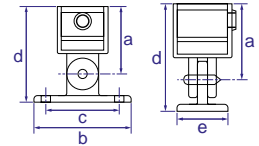

NORMAFIX® BASE SWIVEL COMBINATION

Designation	Diameter in mm	a mm	b mm	c mm	d mm	e mm	Malleable galvanized iron Product No.
BASE SWIVEL COMBINATION 33.7	33.7	61	112	85	93	52	0819 6324 034
BASE SWIVEL COMBINATION 42.4	42.4	69	112	85	98	52	0819 6324 042
BASE SWIVEL COMBINATION 48.3	48.3	77	112	85	109	52	0819 6324 048
BASE SWIVEL COMBINATION 60.3	60.3	89	112	85	121	152	0819 6324 060



Refer to page 199 and 200.

Double swivel combination

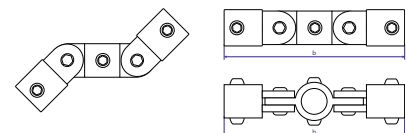

NORMAFIX® DOUBLE SWIVEL COMBINATION

Designation	Diameter in mm	b mm	Malleable galvanized iron Product No.
DOUBLE SWIVEL COMBINATION 33.7	33.7	208	0819 6325 034
DOUBLE SWIVEL COMBINATION 42.4	42.4	228	0819 6325 042
DOUBLE SWIVEL COMBINATION 48.3	48.3	259	0819 6325 048



Refer to page 199 and 200.

90° Corner swivel combination

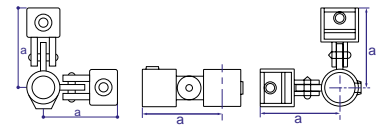

NORMAFIX® 90° CORNER SWIVEL COMBINATION

Designation	Diameter in mm	a mm	Malleable galvanized iron Product No.
90° CORNER SWIVEL COMBINATION 33.7	33.7	104.5	0819 6326 034
90° CORNER SWIVEL COMBINATION 42.4	42.4	117	0819 6326 042
90° CORNER SWIVEL COMBINATION 48.3	48.3	130	0819 6326 048



Refer to page 199 and 200.

Short tee swivel

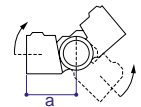

NORMAFIX® SHORT TEE SWIVEL

Designation	Diameter in mm	a mm	Malleable galvanized iron Product No.
SHORT TEE SWIVEL 26.9	26.9	53	0819 6327 027
SHORT TEE SWIVEL 33.7	33.7	59	0819 6327 034
SHORT TEE SWIVEL 42.4	42.4	73	0819 6327 042
SHORT TEE SWIVEL 48.3	48.3	93	0819 6327 048



Refer to page 199 and 200.

Clamp on tee

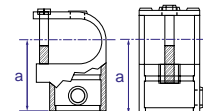

NORMAFIX® CLAMP ON TEE

Designation	Diameter in mm	a mm	Malleable galvanized iron Product No.
CLAMP ON TEE 33.7	33.7	52.5	0819 6328 034
CLAMP ON TEE 42.4	42.4	67	0819 6328 042
CLAMP ON TEE 48.3	48.3	76,5	0819 6327 048



Refer to page 199 and 200.

Fence building clamp

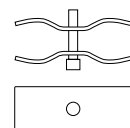

NORMAFIX® FENCE BUILDING CLAMP

Designation	Diameter in mm	Electrolytic yellow passivated Product No.
FENCE BUILDING CLAMP	48	0819 6333 048



Refer to page 199 and 200.

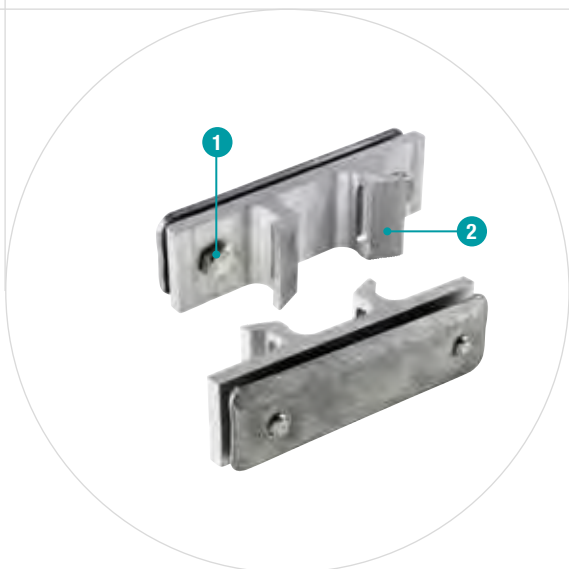

- 1 2 bolts for fixing the clamp on the post
- 2 Round shaped to adapt to the form of the support

Universal traffic sign fixation

Mainly used to hold road signs on a diversity of metal posts or lamppost diameters.



Information

- Includes 2 bolts
- To be used with a worm drive hose clamp

Applications

Traffic signs industry

Material

Aluminum

Technical data & Ordering information

NORMAFIX® ALU BAND CLAMP			
Designation	Length	Number of bolts	Aluminum Product No.
ALU BAND CLAMP	82	2	0560 7563 082
ALU BAND CLAMP	120	2	0560 7563 120



- 1 Dimple on both sides to insert the worm drive hose clamp

Universal traffic sign fixation

Mainly used to hold road signs on a diversity of metal posts or lamppost diameters.



NORMAFIX®

Information

To be used with a worm drive hose clamp

Applications

Traffic signs industry

Materials

Stainless steel

Technical data & Ordering information

NORMAFIX® UNIVERSAL UCC CLAMP	
Designation	Stainless steel Product No.
UNIVERSAL UCC CLAMP	0560 7620 000



NORMAPLAST® - Hose Connectors

For a helping hand in industrial, commercial and private applications
NORMAPLAST® plastic hose connectors – the NORMA® range of products for rapidly connecting hoses and pipes – are the helping hands that no one working in industrial, commercial or private applications should be without.

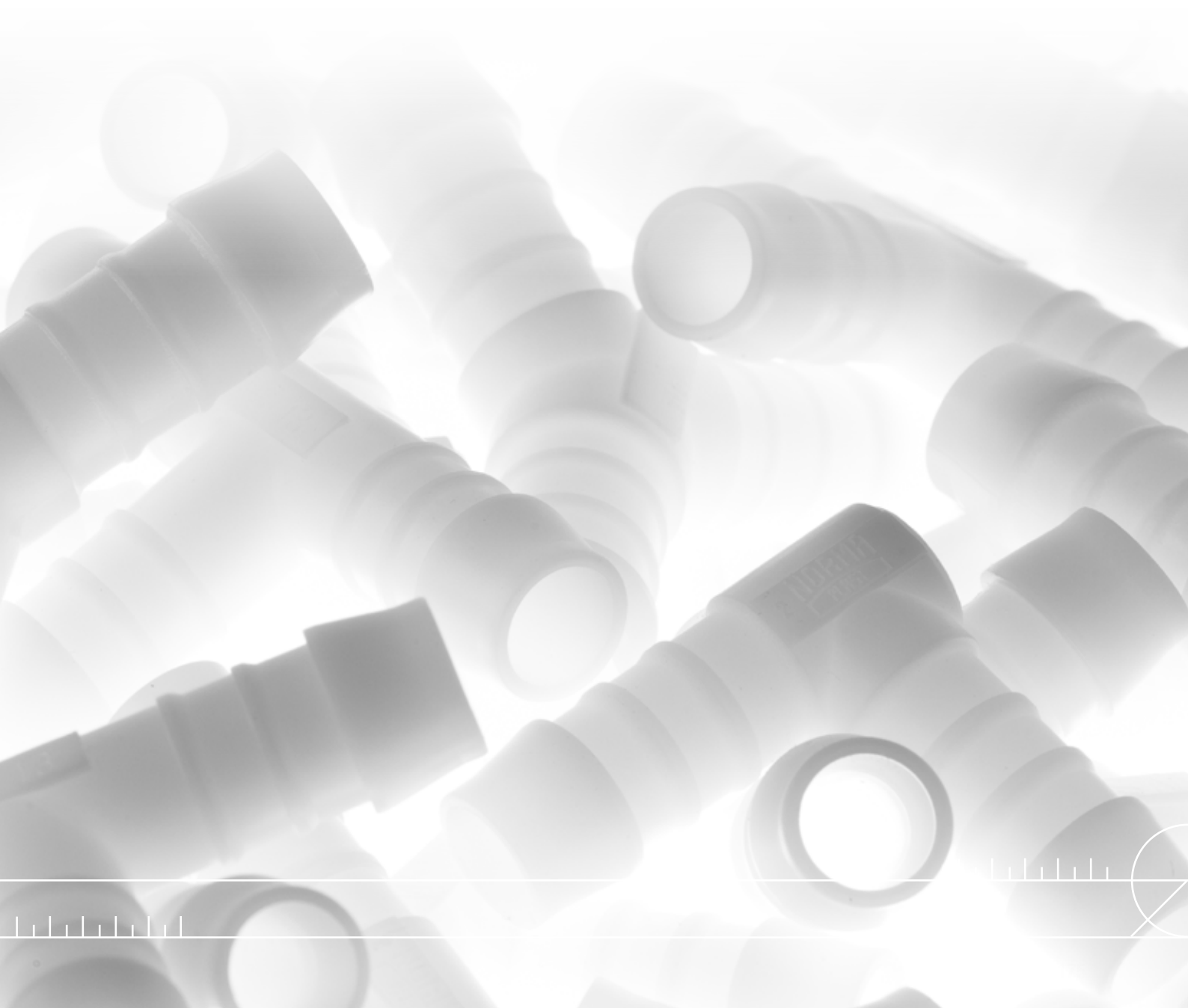



- | | |
|---|---|
| <p>1 NORMAPLAST YN
– Y plastic pipe connectors</p> <p>2 NORMAPLAST TS
– Equal T push-on connectors</p> <p>3 NORMAPLAST GES
– Straight taper thread connectors</p> <p>4 NORMAPLAST TES
– T-taper thread connector</p> <p>5 NORMAPLAST GRS
– Reducing straight push-on connectors</p> | <p>6 NORMAPLAST WN
– Elbow plastic pipe connectors</p> <p>7 NORMAPLAST GN
– Straight plastic pipe connectors</p> <p>8 NORMAPLAST KS
– Cross push-on connectors</p> <p>9 NORMAPLAST GS
– Straight push-on connectors</p> |
|---|---|

Hose connectors

NORMAPLAST® SV products are proven plastic hose and pipe connection components that create secure, reliable and affordable connections in lines used for transporting media.

NORMAPLAST® SV hose and pipe connectors are used in the automotive construction industry as well as practically every other industrial sector.

Advantages at a glance

- Extremely strong
- Durable
- Low weight
- Can be used for damping/absorption
- Resistant to abrasion
- Highly resistant to impact

Applications

- Machine building
- White goods
- Chemical industry
- Irrigation systems
- Food and beverage industry
- Railway industry
- Agricultural machines
- Building machines
- Engine manufacturing
- Pump and filter

Materials

Materials	PP	POM	PA6	PA with glass fiber
Mechanical Properties	Moplen HP501H	Polyacetal copolymer standard material hose connectors	Polyamide unreinforced standard material threaded connectors	Polyamide reinforced standard material pipe connectors
Operation temperature	0°C to +80°C short term (up to 1h) max. +100°C	–40°C to 80°C, short-term (up to 1h) 110°C	–40°C to 90°C, short-term (up to 1h) 120°C	–40°C to 120°C, short-term (up to 1h) 150°C
Max. admissible pressure	10bar	10bar	10bar	10bar

Applications	Recommended material range
Food area / drinking water area / chemical area	>POM<
Chemical area	>PP<
Chemical area (with aggressive media)	>PVDF<
Fuel / UREA (AdBlue) crank case ventilation	>PA12-GF30<
Cooling water / Windshield washer fluid	>PA66-GF30<
Air (Vacuum brake, Secondary air) TOC (Oil cooler, transmission oil)	>PA6-GF30<

Thermal properties

In the case of threaded spigots, the expansion coefficient 100×10^{-6} for thermoplastic material must be taken into consideration if temperature fluctuations occur. Our standard materials are classified in accordance with the UL (Underwriters Laboratories) system as follows:

- Flammability rating (UL94)
- POM, PP, PA6, PA6.6, and PA12: HB (Horizontal Burning)

Materials

Chemical properties of the plastics used								
No.	Chemical substance	Concentration	Temperature	POM	PP	PA 6	PA 6.6	PA 12
1	Acetone	100%	20 °C/50 °C	1/3	1/1	1/0	1/0	1/0
2	Formic acid	98-100%	20 °C/50 °C	4/4	1/3	4/4	4/4	4/4
3	Ammonium hydroxide (spirits of ammonia)	Any	20 °C/50 °C	1/2	1/1	1/0	1/0	1/0
4	Benzene; normal and super unleaded	Commercial	20 °C/50 °C	1/1	3/4	1/1	1/1	1/1
5	Benzene, benzene hydrocarbons	100%	20 °C/50 °C	3/3	3/4	1/0	1/0	1/0
6	Bleaching lye (12.5% active chlorine)	Aqueous solution 12.5%	20 °C/50 °C	4/4	3/3	4/4	4/4	3/3
7	Brake fluid (DOT4)	Commercial	20 °C/50 °C	1/1	1/1	1/1	1/1	1/1
8	Butanol	Technically pure	20 °C/50 °C	1/2	1/1	1/0	1/0	1/0
9	Chlorine, chlorine water	Commercial	20 °C/50 °C	4/4	4/4	4/4	4/4	4/4
10	Disinfectant phenols	Diluted solution	20 °C/50 °C	4/4	1/1	4/4	4/4	4/4
11	Diesel fuel, diesel oil	Commercial	20 °C/50 °C	1/1	1/3	1/1	1/1	1/1
12	Decalcifier	Aqueous solution ~10%	20 °C/50 °C	4/4	1/1	2/3	2/3	2/3
13	Photographic developer (1:100)	Commercial	20 °C/50 °C	1/1	1/1	4/4	4/4	4/4
14	Natural gas (town gas, coal gas)	Commercial	20 °C/50 °C	1/1	1/1	1/1	1/1	1/1
15	Crude oil	Commercial	20 °C/50 °C	1/1	3/3	1/1	1/1	1/1
16	Acetic acid (glacial acetic acid)	90%	20 °C/50 °C	4/4	1/2	4/4	4/4	4/4
17	Ethyl alcohol	96% (tech. pure)	20 °C/50 °C	1/2	1/1	1/0	1/0	1/0
18	Photographic emulsion	Commercial	20 °C/50 °C	1/0	1/1	1/0	1/0	1/0
19	Fruit juices	Commercial	20 °C/50 °C	1/1	1/1	1/1	1/1	1/1
20	Glycerine	Technically pure	20 °C/50 °C	1/1	1/1	1/1	1/1	1/1
21	Glysantin	Commercial	20 °C/50 °C	1/1	1/1	3/3	3/3	3/3
22	Heating oil	Commercial	20 °C/50 °C	1/1	1/3	1/1	1/1	1/1
23	Hydraulic fluid	Commercial	20 °C/50 °C	1/0	1/3	1/1	1/1	1/1
24	Carbon dioxide, carbonic acid	Technically pure, saturated	20 °C/50 °C	1/1	1/1	1/0	1/0	1/0
25	Coolants (based on glycol)	Commercial	20 °C/50 °C	1/1	1/1	3/3	1/1	1/1
26	Methane	Technically pure	20 °C/50 °C	1/1	1/1	1/1	1/1	1/1
27	Methanol	Technically pure	20 °C/50 °C	1/1	1/1	1/1	1/1	3/3
28	Methyl ethyl ketone	100%	20 °C/50 °C	3/3	1/3	1/0	1/0	1/1
29	Engine oils (HD)	Commercial	20 °C/50 °C	1/1	1/3	1/1	1/1	1/1
30	Sodium hydroxide (lye; caustic soda)	40%	20 °C/50 °C	1/1	1/1	1/1	1/1	1/1
31	Ozone	Gaseous	20 °C/50 °C	4/4	3/4	3/4	3/4	3/4
32	Propanol	Technically pure	20 °C/50 °C	1/1	1/1	1/1	1/1	2/2
33	Propane (liquefied gas)	Liquid	20 °C/50 °C	1/1	1/1	1/0	1/0	1/0
34	Propene	96%	20 °C/50 °C	1/0	1/1	1/0	1/0	1/0
35	Rape oil (rape oil methyl ester)	Commercial	20 °C/50 °C	1/1	2/2 (*)	1/1	1/1	1/1
36	Hydrochloric acid	Aqueous, 10%	20 °C/50 °C	4/4	1/1	4/4	4/4	3/3
37	Lubricating oil/grease, soft soap	Commercial	20 °C/50 °C	1/1	1/2	1/1	1/1	1/1
38	Sulphuric acid	Aqueous, 10%	20 °C/50 °C	4/4	1/2	3/3	3/3	2/2
39	De-icing salt solution (brine)	Saturated	20 °C/50 °C	1/2	1/1	1/1	1/1	1/1
40	Soap suds (dissolved detergent)	Diluted solution	20 °C/50 °C	1/1	2/2 (*)	1/1	1/1	1/1
41	Water (drinking, river, sea)	Technically pure	20 °C/50 °C	1/1	1/1	1/1	1/1	1/1
42	Citric acid	10%	20 °C/50 °C	2/4	1/1	1/0	1/0	1/0

Explanation of abbreviations:

POM = Acetal copolymer

PP = Polypropylene

PA = Polyamide

0 = No data available/Not possible to make an appropriate statement

1 = Highly stable/suitable
(change in dimensions: none or negligible and reversible; no damage even after extended period)

2 = Very stable/suitable
(change in dimensions after short period: none or negligible and reversible; little change in dimensions, possibly irreversible change to properties after extended period)

3 = Limited stability
(considerable changes to dimensions, possibly irreversible change to properties after extended period)

4 = Unstable/unsuitable
(soluble or serious effects after a short period)

(*) Moisture expansion

The specifications in this catalogue are based on tests carried out by the Please contact the relevant manufacturer before using a product as a granular material manufacturer. They are intended to serve as guidelines safety component.

for our customers, but cannot simply be applied to any case in which customers expose these products to demands which fall outside the scope of the tests performed. On no account should this be done without first consulting us.

Our customers must perform their own tests to determine whether our **NORMAPLAST®** plastic hose connecting components are suitable for the application they are intended to be used in. We will be happy to offer any advice or information required.

Our liability is subject exclusively to our terms of delivery and sale. Special versions can be produced if an appropriate quantity of the component in question is ordered.

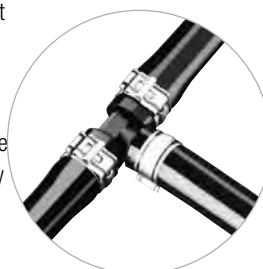

Use as a hose connector

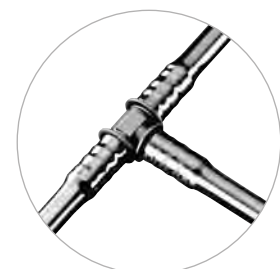

Use as a push-on connector

GES – Straight taper thread connectors

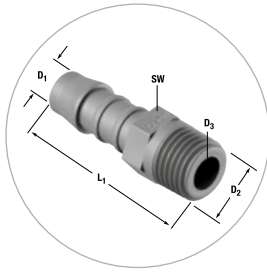

Nominal size ID hose (in mm)	Designation	D_1	D_2	D_3	L_1	SW	Material PA6 Product No.
3	GES 3 / M 5	3	M 5 cyl	2.5	19.5	6	0710 8952 003
4	GES 4 / M 8 x 1	4	M 8 x 1 con.	2.5	27	10	0710 8901 004
	GES 4 / M 8 x 1.25	4	M 8 x 1.25 con.	2.5	27	10	0710 8902 004
	GES 4 / M 10 x 1	4	M 10 x 1 con.	2.5	27	10	0710 8903 004
	GES 4 / M 12 x 1.5	4	M 12 x 1.5 con.	2.5	32	14	0710 8904 004
	GES 4 / M 14 x 1.5	4	M 14 x 1.5 con.	2.5	32	14	0710 8905 004
	GES 4 / R 1/8	4	R 1/8 con.	2.5	27	10	0710 8910 004
	GES 4 / R 1/4	4	R 1/4 con.	2.5	32	14	0710 8911 004
	GES 4 / 1/8 NPT	4	1/8 NPT	2.5	29	10	0710 8917 004
GES 4 / 1/4 NPT	4	1/4 NPT	2.5	35	14	0710 8918 004	
5	GES 5 / M 12 x 1.5	5	M 12 x 1.5 con.	3	36	14	0710 8904 005
	GES 5 / M 14 x 1.5	5	M 14 x 1.5 con.	3	36	14	0710 8905 005
	GES 5 / R 1/4	5	R 1/4 con.	3	36	14	0710 8911 005
	GES 5 / R 1/4 NPT	5	R 1/4 NPT	3	39	14	0710 8918 005
6	GES 6 / M 10 x 1	6	M 10 x 1 con.	4	32.5	10	0710 8903 006
	GES 6 / M 12 x 1.5	6	M 12 x 1.5 con.	4	37.5	14	0710 8904 006
	GES 6 / M 14 x 1.5	6	M 14 x 1.5 con.	4	36.5	14	0710 8905 006
	GES 6 / R 1/8	6	R 1/8 con.	4	32.5	10	0710 8910 006
	GES 6 / R 1/4	6	R 1/4 con.	4	37.5	14	0710 8911 006
	GES 6 / R 3/8	6	R 3/8 con.	4	39	17	0710 8912 006
	GES 6 / 1/8 NPT	6	1/8 NPT	4	34.5	10	0710 8917 006
	GES 6 / 1/4 NPT	6	1/4 NPT	4	40.5	14	0710 8918 006
8	GES 8 / M 10 x 1	8	M 10 x 1 con.	5.6	38	14	0710 8903 008
	GES 8 / M 12 x 1.5	8	M 12 x 1.5 con.	5.6	41	14	0710 8904 008
	GES 8 / M 14 x 1.5	8	M 14 x 1.5 con.	5.6	41	14	0710 8905 008
	GES 8 / M 18 x 1.5	8	M 18 x 1.5 con.	5.6	49	22	0710 8907 008
	GES 8 / M 22 x 1.5	8	M 22 x 1.5 con.	5.6	49	22	0710 8949 008
	GES 8 / M 26 x 1.5	8	M 26 x 1.5 con.	5.6	58	27	0710 8908 008
	GES 8 / R 1/8	8	R 1/8 con.	5.6	38	14	0710 8910 008
	GES 8 / R 1/4	8	R 1/4 con.	5.6	41	14	0710 8911 008
	GES 8 / R 3/8	8	R 3/8 con.	5.6	41	17	0710 8912 008
	GES 8 / R 1/2	8	R 1/2 con.	5.6	49	22	0710 8913 008
GES 8 / 1/4 NPT	8	1/4 NPT	5.6	44	14	0710 8918 008	
10	GES 10 / M 12 x 1.5	10	M 12 x 1.5 con.	7	43.5	14	0710 8904 010
	GES 10 / M 14 x 1.5	10	M 14 x 1.5 con.	7	43.5	14	0710 8905 010
	GES 10 / M 16 x 1.5	10	M 16 x 1.5 con.	7	43.5	17	0710 8906 010
	GES 10 / R 1/4	10	R 1/4 con.	7	43.5	14	0710 8911 010
	GES 10 / R 3/8	10	R 3/8 con.	7	43.5	17	0710 8912 010
	GES 10 / 1/4 NPT	10	1/4 NPT	7	46.5	14	0710 8918 010
GES 10 / 3/8 NPT	10	3/8 NPT	7	46.5	17	0710 8919 010	
12	GES 12 / M 16 x 1.5	12	M 16 x 1.5 con.	8.6	45.5	17	0710 8906 012
	GES 12 / M 18 x 1.5	12	M 18 x 1.5 con.	8.6	54	22	0710 8907 012
	GES 12 / M 22 x 1.5	12	M 22 x 1.5 con.	8.6	54	22	0710 8949 012
	GES 12 / M 26 x 1.5	12	M 26 x 1.5 con.	8.6	58	27	0710 8909 012
	GES 12 / R 3/8	12	R 3/8 con.	8.6	45.5	17	0710 8912 012
	GES 12 / R 1/2	12	R 1/2 con.	8.6	54	22	0710 8913 012
GES 12 / 3/8 NPT	12	3/8 NPT	8.6	48	17	0710 8919 012	
14	GES 14 / M 20 x 1.5	14	M 20 x 1.5 con.	10	56	22	0710 8908 014
	GES 14 / R 3/8	14	R 3/8 con.	10	56	17	0710 8912 014
	GES 14 / R 1/2	14	R 1/2 con.	10	56	22	0710 8913 014
	GES 14 / R 1/2 NPT	14	R 1/2 NPT	10	58	22	0710 8920 014
16	GES 16 / M 26 x 1.5	16	M 26 x 1.5 con.	12	58	27	0710 8909 016
	GES 16 / R 1/2	16	R 1/2 con.	12	58	22	0710 8913 016
	GES 16 / R 3/4	16	R 3/4 con.	12	58	27	0710 8914 016
19	GES 19 / M 26 x 1.5	19	M 26 x 1.5 con.	15	58	27	0710 8909 019
	GES 19 / R 3/4	19	R 3/4 con.	15	58	27	0710 8914 019
25	GES 25 / R 1	25	R 1 con.	21	69	32	0710 8915 025

BST – Blanking plugs with screw-in thread

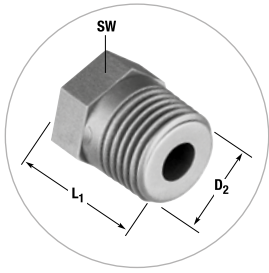

Designation	D ₂	L ₁ ~	SW	Material PA6 Product No.
BST M 8 x 1	M 8 x 1 con.	13	10	0711 8901 000
BST M 10 x 1	M 10 x 1 con.	13.5	10	0711 8903 000
BST M 12 x 1.5	M 12 x 1.5 con.	17.5	14	0711 8904 000
BST M 14 x 1.5	M 14 x 1.5 con.	17.5	14	0711 8905 000
BST M 18 x 1.5	M 18 x 1.5 con.	26.5	22	0711 8907 000
BST M 20 x 1.5	M 20 x 1.5 con.	25	22	0711 8908 000
BST M 26 x 1.5	M 26 x 1.5 con.	26.5	22	0711 8909 000
BST R 1/8	R 1/8 con.	26	22	0711 8910 000
BST R 1/4	R 1/4 con.	12.5	10	0711 8911 000
BST R 3/8	R 3/8 con.	17.5	14	0711 8912 000
BST R 1/2	R 1/2 con.	27	17	0711 8913 000
BST 1/8 NPT	1/8 NPT	27.5	22	0711 8917 000
BST 1/4 NPT	1/4 NPT	14	10	0711 8918 000
BST M 22 x 1.5	M 22 x 1.5 con.	20.5	14	0711 8949 000

TES – T-taper thread connectors

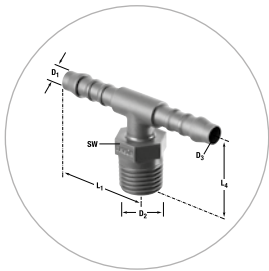

Nominal size ID hose (in mm)	Designation	D ₁	D ₂	D ₃	L ₁ ~	L ₂ ~	SW	Material PA6 Product No.
4	TES 4 / M 8 x 1	4	M 8 x 1 con.	2.5	21	18	10	0720 8901 004
	TES 4 / M 10 x 1	4	M 10 x 1 con.	2.5	21	18	10	0720 8903 004
	TES 4 / M 12 x 1.5	4	M 12 x 1.5 con.	2.9	21	23	14	0720 8904 004
	TES 4 / R 1/8	4	R 1/8 con.	2.5	21	18	10	0720 8910 004
	TES 4 / R 1/4	4	R 1/4 con.	2.5	21	23	14	0720 8911 004
	TES 4 / 1/8 NPT	4	1/8 NPT	2.5	21	20	10	0720 8917 004
	TES 4 / 1/4 NPT	4	1/4 NPT	2.5	21	26	14	0720 8918 004
6	TES 6 / M 10 x 1	6	M 10 x 1 con.	4	28.5	21	10	0720 8903 006
	TES 6 / M 12 x 1.5	6	M 12 x 1.5 con.	4	28.5	26	14	0720 8904 006
	TES 6 / R 1/8	6	R 1/8 con.	4	28.5	21	10	0720 8910 006
	TES 6 / R 1/4	6	R 1/4 con.	4	28.5	26	14	0720 8911 006
	TES 6 / 1/8 NPT	6	1/8 NPT	4	28.5	23	10	0720 8917 006
TES 6 / 1/4 NPT	6	1/4 NPT	4	28.5	29	14	0720 8918 006	
8	TES 8 / M 12 x 1.5	8	M 12 x 1.5 con.	5.6	33	27.5	14	0720 8904 008
	TES 8 / M 14 x 1.5	8	M 14 x 1.5 con.	5.6	33	27.5	14	0720 8905 008
	TES 8 / R 1/4	8	R 1/4 con.	5.6	33	27.5	14	0720 8911 008
	TES 8 / 1/4NPT	8	1/4NPT	5.6	33	30.5	14	0720 8918 008
10	TES 10 / R 3/8	10	R 3/8 con.	7	35.5	30	17	0720 8912 010

WES – Elbow taper thread connectors

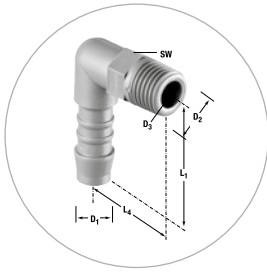

Nominal size ID hose (in mm)	Designation	D ₁	D ₂	D ₃	L ₁ ~	L ₂ ~	SW	Material PA6 Product No.
3	WES 3 / M 5 cyl.	3	M 5 cyl.	2.5	12.5	12.5	6	0730 8952 003
4	WES 4 / M 8 x 1	4	M 8 x 1 con.	2.7	21	16	10	0730 8901 004
	WES 4 / M 10 x 1	4	M 10 x 1 con.	2.7	21	16	10	0730 8903 004
	WES 4 / M 12 x 1.5	4	M 12 x 1.5 con.	2.7	21	25	14	0730 8904 004
	WES 4 / M 14 x 1.5	4	M 14 x 1.5 con.	2.7	21	25	14	0730 8905 004
	WES 4 / R 1/8	4	R 1/8 con.	2.7	21	16	10	0730 8910 004
	WES 4 / R 1/4	4	R 1/4 con.	2.7	21	25	14	0730 8911 004
	WES 4 / 1/8 NPT	4	1/8 NPT	2.7	21	18	10	0730 8917 004
WES 4 / 1/4 NPT	4	1/4 NPT	2.7	21	28	14	0730 8918 004	
6	WES 6 / M 10 x 1	6	M 10 x 1 con.	4	28.5	21	10	0730 8903 006
	WES 6 / M 12 x 1.5	6	M 12 x 1.5 con.	4	28.5	26	14	0730 8904 006
	WES 6 / R 1/8	6	R 1/8 con.	4	28.5	21	10	0730 8910 006
	WES 6 / R 1/4	6	R 1/4 con.	4	28.5	26	14	0730 8911 006
	WES 6 / R 3/8	6	R 3/8 con.	4	28.5	27	17	0730 8912 006
	WES 6 / 1/8 NPT	6	1/8 NPT	4	28.5	23	10	0730 8917 006
	WES 6 / 1/4 NPT	6	1/4 NPT	4	28.5	29	14	0730 8918 006
8	WES 8 / M 10 x 1	8	M 10 x 1 con.	5.6	33	23.5	14	0730 8903 008
	WES 8 / M 12 x 1.5	8	M 12 x 1.5 con.	5.6	33	27.5	14	0730 8904 008
	WES 8 / M 14 x 1.5	8	M 14 x 1.5 con.	5.6	33	27.5	14	0730 8905 008
	WES 8 / M 16 x 1.5	8	M 16 x 1.5 con.	5.6	36	27.5	17	0730 8906 008
	WES 8 / M 18 x 1.5	8	M 18 x 1.5 con.	5.6	36	36	19	0730 8907 008
	WES 8 / M 22 x 1.5	8	M 22 x 1.5 con.	5.6	36	36	22	0730 8949 008
	WES 8 / R 1/8	8	R 1/8 con.	5.6	33	23	14	0730 8910 008
	WES 8 / R 1/4	8	R 1/4 con.	5.6	33	27.5	14	0730 8911 008
	WES 8 / R 3/8	8	R 3/8 con.	5.6	36	31	17	0730 8912 008
	WES 8 / R 1/2	8	R 1/2 con.	5.6	36	36	22	0730 8913 008
	WES 8 / 1/4 NPT	8	1/4 NPT	5.6	33	30.5	14	0730 8918 008
10	WES 10 / M 14 x 1.5	10	M 14 x 1.5 con.	7	38	30	14	0730 8905 010
	WES 10 / R 1/4	10	R 1/4	7	38	30	14	0730 8911 010
	WES 10 / R 3/8	10	R 3/8	7	38	30	17	0730 8912 010
	WES 10 / 1/2 NPT	10	1/2 NPT	7	38	38	22	0730 8920 010
12	WES 12 / M 16 x 1.5	12	M 16 x 1.5 con.	8.6	40.5	30	17	0730 8906 012
	WES 12 / M 18 x 1.5	12	M 18 x 1.5 con.	8.6	40.5	36	19	0730 8907 012
	WES 12 / M 22 x 1.5	12	M 22 x 1.5 con.	8.6	40.5	36	22	0730 8949 012
	WES 12 / M 26 x 1.5	12	M 26 x 1.5 con.	8.6	40.5	36	22	0730 8909 012
	WES 12 / R 3/8	12	R 3/8	8.6	40.5	31	17	0730 8912 012
	WES 12 / R 1/2	12	R 1/2	8.6	40.5	36	22	0730 8913 012
	WES 12 / 3/8 NPT	12	3/8 NPT	8.6	40.5	31	19	0730 8919 012
19	WES 19 / M 24 x 2	19	M 24 x 2 con.	15	45	42.8	27	0730 8953 019
	WES 19 / R 3/4	19	R 3/4 con.	15	45.5	42.8	27	0730 8914 019
25	WES 25 / R 1	25	R 1 con.	21	60	49	32	0730 8915 025

GS – Straight push-on connectors

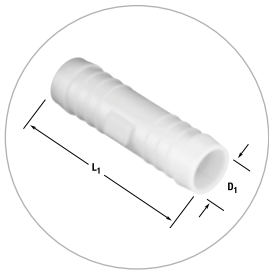

Nominal size ID hose (in mm)	Designation	D ₁	D ₂	L ₁ ~	Material POM Product No.
3	GS 3	3	2.5	25	0750 8900 003
4	GS 4	4	2.7	35	0750 8900 004
5	GS 5	5	3	45	0750 8900 005
6	GS 6	6	4	49	0750 8900 006
8	GS 8	8	5.6	56	0750 8900 008
10	GS 10	10	7	63	0750 8900 010
12	GS 12	12	8.6	66.5	0750 8900 012
13	GS 13	13	8.6	73	0750 8900 013
14	GS 14	14	10	79	0750 8900 014
16	GS 16	16	12	75	0750 8900 016
19	GS 19	19	15	76	0750 8900 019
25	GS 25	25	21	95	0750 8900 025

Additional materials available on request



Refer to pages 192 and 193.

GRS – Reducing straight push-on connectors

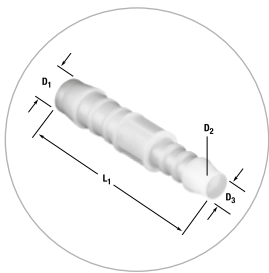

Nominal size ID hose (in mm)	Designation	D ₁	D ₂	D ₃	L ₁ ~	Material POM Product No.
4 - 3	GRS 4 - 3	4	2.5	3	30	0751 8904 003
5 - 4	GRS 5 - 4	5	2.7	3	41	0751 8905 004
6 - 4	GRS 6 - 4	6	2.7	4	42.5	0751 8906 004
8 - 4	GRS 8 - 4	8	2.7	4	48	0751 8908 004
8 - 6	GRS 8 - 6	8	4	6	54	0751 8908 006
10 - 6	GRS 10 - 6	10	4	6	58	0751 8910 006
10 - 8	GRS 10 - 8	10	5.6	8	60.5	0751 8910 008
12 - 8	GRS 12 - 8	12	5.6	8	62.5	0751 8912 008
12 - 10	GRS 12 - 10	12	7	10	64	0751 8912 010

Additional materials available on request



Refer to pages 193.

TS – Equal T push-on connectors

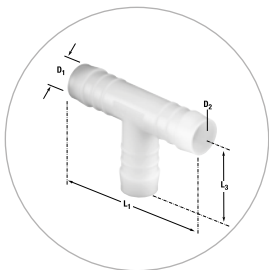

Nominal size ID hose (in mm)	Designation	D ₁	D ₂	L ₁ ~	L ₂ ~	Material POM Product No.
3	TS 3	3	2.5	25	12.5	0760 8900 003
4	TS 4	4	2.7	35	19.5	0760 8900 004
5	TS 5	5	3	42	22	0760 8900 005
6	TS 6	6	4	50	26	0760 8900 006
7	TS 7	7	5	50	26	0760 8900 007
8	TS 8	8	5.6	58	30	0760 8900 008
10	TS 10	10	7	62.5	33.5	0760 8900 010
12	TS 12	12	8.6	69	36	0760 8900 012
13	TS 13	13	8.6	68	36	0760 8900 013
14	TS 14	14	10	77.5	41.5	0760 8900 014
15	TS 15	15	11	79.5	43.5	0760 8900 015
16	TS 16	16	12	81	45	0760 8900 016
19	TS 19	19	15	85	45	0760 8900 019
25	TS 25	25	21	105	52.5	0760 8900 025

Additional materials available on request



Refer to pages 192 and 193.

KS – Cross push-on connectors

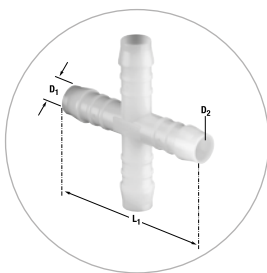

Nominal size ID hose (in mm)	Designation	D ₁	D ₂	L ₁ ~	Material POM Product No.
4	KS 4	4	2.9	39	0772 8900 004
5	KS 5	5	3	48	0772 8900 005
6	KS 6	6	4	48	0772 8900 006
12	KS 12	12	8.6	69	0772 8900 012

Additional materials available on request

TRS – Reducing T push-on connectors

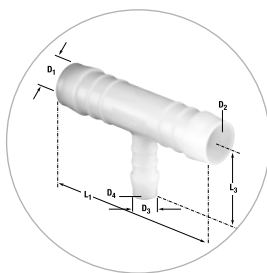

Nominal size ID hose (in mm)	Designation	D ₁	D ₂	D ₃	D ₄	L ₁ ~	L ₄ ~	Material POM Product No.
3 - 4 - 3	TRS 3 - 4 - 3	3	2.5	4	2.5	25	17.5	0761 8903 004
4 - 6 - 4	TRS 4 - 6 - 4	4	2.7	6	4	37	24	0761 8904 006
6 - 4 - 6	TRS 6 - 4 - 6	6	4	4	2.5	49	20.5	0761 8906 004
8 - 4 - 8	TRS 8 - 4 - 8	8	5.6	4	2.5	56	22	0761 8908 004
8 - 6 - 8	TRS 8 - 6 - 8	8	5.6	6	4	56	28	0761 8908 006
8 - 12 - 8	TRS 8 - 12 - 8	8	5.6	12	8.6	57	34	0761 8908 012
10 - 6 - 10	TRS 10 - 6 - 10	10	7	6	4	62	28	0761 8910 006
10 - 8 - 10	TRS 10 - 8 - 10	10	7	8	5.6	62	31	0761 8910 008
10 - 13 - 10	TRS 10 - 13 - 10	10	7	13	8.6	64	38	0761 8910 013
12 - 6 - 12	TRS 12 - 6 - 12	12	8.6	6	4	69	29	0761 8912 006
12 - 8 - 12	TRS 12 - 8 - 12	12	8.6	8	5.6	69	31	0761 8912 008
12 - 10 - 12	TRS 12 - 10 - 12	12	8.6	10	7	69	33	0761 8912 010
15 - 6 - 15	TRS 15 - 6 - 15	15	11	6	4	78	28	0761 8915 006
15 - 8 - 15	TRS 15 - 8 - 15	15	11	8	5.6	79	33	0761 8915 008
18 - 10 - 18	TRS 18 - 10 - 18	18	14	10	7	79	36	0761 8918 010
18 - 15 - 18	TRS 18 - 15 - 18	18	14	15	11	80	44	0761 8918 015

Additional materials available on request

YRS – Reducing Y push-on connectors

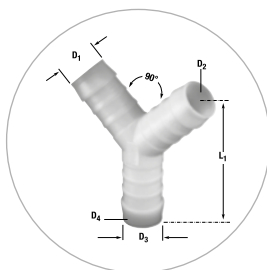

Nominal size ID hose (in mm)	Designation	D ₁	D ₂	D ₃	D ₄	L ₁ ~	Material POM Product No.
4 - 6 - 4	YRS 4 - 6 - 4	4	2.7	6	4	35	0771 8904 006
6 - 8 - 6	YRS 6 - 8 - 6	6	4	8	5.6	49	0771 8906 008

Additional materials available on request

NORMAPLAST®

WS – Elbow push-on connectors

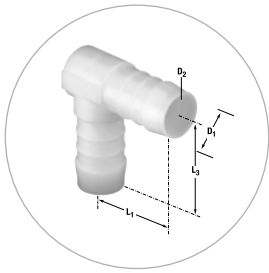

Nominal size ID hose (in mm)	Designation	D ₁	D ₂	L ₁ ~	L ₂ ~	Material POM Product No.
3	WS 3	3	2.5	12.5	12.5	0762 8900 003
4	WS 4	4	2.5	17.5	19.5	0762 8900 004
5	WS 5	5	3	21	22	0762 8900 005
6	WS 6	6	4	25	26	0762 8900 006
8	WS 8	8	5.6	29	30	0762 8900 008
10	WS 10	10	7	31	33.5	0762 8900 010
12	WS 12	12	8.6	34.5	36	0762 8900 012
13	WS 13	13	8.6	36.5	38.5	0762 8900 013
14	WS 14	14	10	38.5	41.5	0762 8900 014
15	WS 15	15	11	40	43.5	0762 8900 015
16	WS 16	16	12	40.5	45	0762 8900 016
19	WS 19	19	15	43.5	46	0762 8900 019
25	WS 25	25	21	52.5	52.5	0762 8900 025

Additional materials available on request

YS – Equal Y push-on connectors

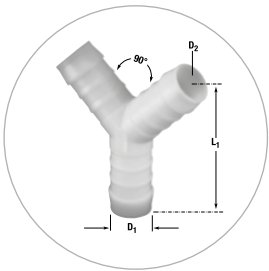

Nominal size ID hose (in mm)	Designation	D ₁	D ₂	L ₁ ~	Material POM Product No.
3	YS 3	3	2.5	21	0770 8900 003
4	YS 4	4	2.5	25.5	0770 8900 004
5	YS 5	5	3	43	0770 8900 005
6	YS 6	6	4	44	0770 8900 006
8	YS 8	8	5.6	51	0770 8900 008
10	YS 10	10	7	54	0770 8900 010
12	YS 12	12	8.6	64	0770 8900 012
13	YS 13	13	9	65	0770 8900 013
14	YS 14	14	10	65	0770 8900 014
16	YS 16	16	12	67	0770 8900 016
19	YS 19	19	15	72	0770 8900 019

Additional materials available on request



Refer to page 193.

GN – Straight plastic pipe connectors

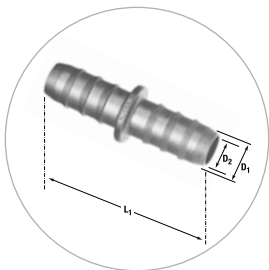

Nominal size ID PA tube (in mm)	Designation	D ₁	D ₂	L ₁ ~	Material PAG -GF30* Product No.	Material PA12-GF20* Product No.	Material PA12-GF30* Product No.
6	GN 6	6.4	4.75	45			0750 8200 006
8	GN 8	9.2	6.8	46	0750 8074 008		
10	GN 10	11	8	46	0750 8300 010		0750 8200 010
15	GN 15	16.9	12	32		0750 8001 015	
19	GN 19	21	16	39		0750 8001 019	
27	GN 27	29	24	42		0750 8001 027	
27 - 19	GRN 27 - 19	29 - 21	24 - 16	44		0751 8045 000	

* Glass fiber content

TN – T plastic pipe connectors

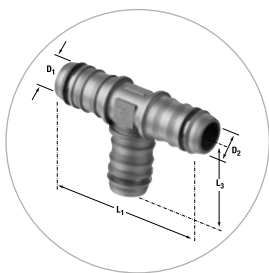

Nominal size ID PA tube (in mm)	Designation	D ₁	D ₂	L ₁ ~	L ₃ ~	Material PA6 -GF30* Product No.	Material PA66-GF30* Product No.	Material PA12-GF30* Product No.
4	TN 4	4.6	2.5	43	23	0760 8129 004		
6	TN 6	6.4	4.75	56.5	28.5	0760 8202 006	0760 8203 006	0760 8200 006
8	TN 8	9.2	6.8	58	29	0760 8112 008		0760 8200 008
10	TN 10	11	8	60	30			0760 8200 010
15	TN 15	16.4	12	72	36			0760 8200 015
19	TN 19	18.9	16	65	32.5			0760 8201 019
15-8-15	TN 15-8-15	16.4-8.9-16.4	12-6-12	72	35			0761 8052 000
15-12-15	TN 15-12-15	16.4-13.5-16.4	12-10.5-12	72	35.5			0761 8015 012

* Glass fiber content

WN – Elbow plastic pipe connectors

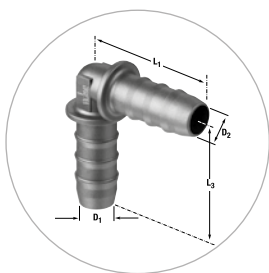

Nominal size ID PA tube (in mm)	Designation	D ₁	D ₂	L ₁ ~	L ₃ ~	Material PA6 -GF30* Product No.	Material PA66-GF30* Product No.	Material PA12-GF30* Product No.
6	WN 6	6.4	4.75	28	28		0762 8205 006	0762 8200 006
8	WN 8	9.2	6.8	29	29	0762 8067 008		0762 8200 008
10	WN 10	11	8	30	30	0762 8201 010		0762 8200 010
19	WN 19	18.9	16	32	32			0762 8200 019

* Glass fiber content

YN – Y plastic pipe connectors

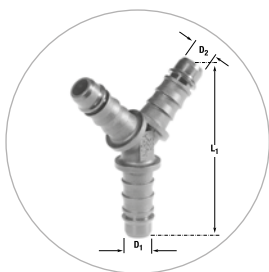

Nominal size ID PA tube (in mm)	Designation	D ₁	D ₂	L ₁ ~	Material PA66-GF30* Product No.	Material PA12-GF20* Product No.	Material PA12-GF30* Product No.
8	YN 8	8.4	5.8	50.5	0770 8203 008		0770 8200 008
10	YN 10	11	8	80			0770 8200 010
15	YN 15	14.9	12	49.3			0770 8200 015
19	YN 19	18.9	16	85		0770 8201 019	

* Glass fiber content

NORMAPLAST®

EG – Straight compression connectors



Nominal size ID PA tube (in mm)	Designation	D ₁	D ₂	L ₁ ~	SW	Diameter	Material PA12-GF30* Product No.
6	EG 6 x 1-R 1/8	6 x 1	R 1/8 con.	25	13	6 x 1-R 1/8	0780 8900 001
	EG 6 x 1-R 1/4	6 x 1	R 1/4 con.	31	17	6 x 1-R 1/4	0780 8900 002
	EG 6 x 1-M10 x 1	6 x 1	M10 x 1 con.	25	13	6 x 1-M10 x 1	0780 8900 003
8	EG 8 x 1-R 1/8	8 x 1	R 1/8 con.	25	13	8 x 1-R 1/8	0780 8900 021
	EG 8 x 1-R 1/4	8 x 1	R 1/4 con.	31	17	8 x 1-R 1/4	0780 8900 022
	EG 8 x 1-M10 x 1	8 x 1	M10 x 1 con.	25	13	8 x 1-M10 x 1	0780 8900 023

* Glass fiber content

EWS – Swivel elbow compression connectors



Nominal size ID PA tube (in mm)	Designation	D ₁	D ₂	L ₁ ~	L ₂ ~	L ₃ ~	SW	Material PAG-GF30* Product No.
6	EWS 6 x 1-R 1/8	6 x 1	R 1/8	14	21	30	13	0780 8901 001
	EWS 6 x 1-R 1/4	6 x 1	R 1/4	15	23	33.5	17	0780 8901 002
	EWS 6 x 1-M10 x 1	6 x 1	M10 x 1	14	21	30	13	0780 8901 003
8	EWS 8 x 1-R 1/8	8 x 1	R 1/8	14	21	30	13	0780 8901 021
	EWS 8 x 1-R 1/4	8 x 1	R 1/4	15	23	33.5	17	0780 8901 022
	EWS 8 x 1-M10 x 1	8 x 1	M10 x 1	14	21	30	13	0780 8901 023

* Glass fiber content

ETS – Swivel T compression connectors

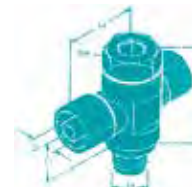

Nominal size ID PA tube (in mm)	Designation	D ₁	D ₂	L ₁ ~	L ₂ ~	L ₃ ~	SW	Material PAG-GF30* Product No.
6	ETS 6 x 1-R 1/8	6 x 1	R 1/8	14	21	30	13	0780 8902 001
	ETS 6 x 1-R 1/4	6 x 1	R 1/4	15	23	33.5	17	0780 8902 002
	ETS 6 x 1-M10 x 1	6 x 1	M10 x 1	14	21	30	13	0780 8902 003
8	ETS 8 x 1-R 1/8	8 x 1	R 1/8	15	23	33.5	17	0780 8902 021

* Glass fiber content

ET – T compression connectors

Nominal size ID PA tube (in mm)	Designation	D ₁	D ₂	L ₁ ~	L ₂ ~	Material PA6-GF30* Product No.
6	ET 6 x 1-R 1/8	6 x 1	R 1/8 con.	19	23	0780 8904 001
	ET 6 x 1-R 1/4	6 x 1	R 1/4 con.	23	23	0780 8904 002
	ET 6 x 1-M10 x 1	6 x 1	M10 x 1 con.	19	23	0780 8904 003
8	ET 8 x 1-R 1/8	8 x 1	R 1/8 con.	19	23	0780 8904 021
	ET 8 x 1-R 1/4	8 x 1	R 1/4 con.	23	23	0780 8904 022
	ET 8 x 1-M10 x 1	8 x 1	M10 x 1 con.	19	23	0780 8904 023

* Glass fiber content

EW/WV – Elbow compression connectors

Nominal size ID PA tube (in mm)	Designation	D ₁	D ₂	L ₁ ~	L ₂ ~	Material PA6-GF30* Product No.
6	EW 6 x 1 - R 1/8	6 x 1	R 1/8 con.	19	23	0780 8905 001
	EW 6 x 1 - R 1/4	6 x 1	R 1/4 con.	23	23	0780 8905 002
	EW 6 x 1 - M10 x 1	6 x 1	M10 x 1 con.	19	23	0780 8905 003
8	EW 8 x 1 - R 1/8	8 x 1	R 1/8 con.	19	23	0780 8905 021
	EW 8 x 1 - R 1/4	8 x 1	R 1/4 con.	23	23	0780 8905 022
	EW 8 x 1 - M10 x 1	8 x 1	M10 x 1 con.	19	23	0780 8905 023
	WV 8 x 1	8 x 1	8 x 1	23	23	0781 8900 011

* Glass fiber content

VT/VTR – Equal T and reducing T compression connectors



Nominal size ID PA tube (in mm)	Designation	D ₁	D ₂	L ₁ ~	L ₂ ~	Material PA6-GF30* Product No.
N/A	VT 6 x 1	6 x 1	6 x 1	23	23	0781 8900 001
	VT 8 x 1	8 x 1	8 x 1	23	23	0781 8900 002
	VTR 6 x 1-8 x 1-6 x 1	6 x 1	8 x 1	23	23	0781 8900 021
	VTR 8 x 1-6 x 1-8 x 1	8 x 1	6 x 1	23	23	0781 8900 022

* Glass fiber content

VG/VGR – Straight/Reducing compression connectors

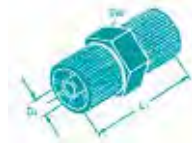

Nominal size ID PA tube (in mm)	Designation	D ₁	L ₁ ~	SW	Material PA6-GF30* Product No.
N/A	VG 6 x 1	6 x 1	31	17	0781 8901 003
	VG 8 x 1	8 x 1	31	17	0781 8901 002
	VGR 8 x 1 - 6 x 1	6 x 1	31	17	0781 8901 004

* Glass fiber content



NORMA

NORMACLAM TORRO

W2

www.normagroup.com

4-6,5 mm	18 g
10-12,5 mm	20 g
16-17,5 mm	25 g
20-22,5 mm	30 g
25-30,5 mm	35 g
30-32,5 mm	40 g

NORMAEXTRA® - Kits, Assortments, Displays, Tools and Accessories

A wide range of assortments, displays, dispensers and tools

NORMA assortments section offers the possibility of having several clamp diameters in one package. All the accessories and the tools mentioned in this chapter are proposed to enable simple and easy installation of the NORMA products.



NORMAFIX® NORMETTA® Mini repair kits



NORMAFIX® NORMETTA® MINI REPAIR KITS					
Width	Designation	Length in m	Number of closures	Closure type	W1 Product No.
5	MINI REPAIR KIT 8/5	8	25	NB-A5	0560 8520 003
9	MINI REPAIR KIT 8/9	8	25	NB-A9	0560 8520 001

NORMACLAMP® Quick lock Band-on-roll



NORMACLAMP® QUICK LOCK BAND-ON-ROLL					
Width	Designation	Length in m	Number of closures	W2 Product No.	W4 Product No.
9	BAND-ON-ROLL 3M	3	8	0815 7121 001	0815 7131 001
	BAND-ON-ROLL 5M	5	8	0815 7121 003	0815 7131 003
12	BAND-ON-ROLL 3M	3	6	0815 6007 002	
	BAND-ON-ROLL 5M	5	6	0815 6007 004	

NORMACLAMP® TORRO® Assortment type 120 pcs



NORMACLAMP® TORRO ASSORTMENT TYPE 120 PCS					
Width	Designation	Clamping range	Quantity	W1 Product No.	W4 Product No.
9	TORRO 8 - 16/9	8 - 16	40	0126 5005 012	0126 5005 014
	TORRO 12 - 22/9	12 - 22	25		
	TORRO 16 - 27/9	16 - 27	20		
	TORRO 20 - 32/9	20 - 32	15		
	TORRO 25 - 40/9	25 - 40	10		
	TORRO 35 - 50/9	35 - 50	10		
NA	FLEXIDRIVER	NA	1		

NORMACLAMP® COBRA kit type 500k



This workshop range is a clearly arranged collection of the most commonly used types of **NORMACLAMP®** COBRA hose clips in a practical plastic case (approx. 34x23x5 cm).

A workshop range comprises of 500 **NORMACLAMP®** COBRA hose clips made from stainless steel nickel chromium steel and with band widths of 7 mm and 8 mm as follows:

NORMACLAMP® COBRA KIT TYPE 500K				
Width	Designation	Diameter	Quantity	W4 Product No.
7	COBRA 7.5/7	7.5	30	0773 9000 500
	COBRA 8/7	8	25	
	COBRA 8.5/7	8.5	25	
	COBRA 9/7	9	25	
	COBRA 9.5/7	9.5	25	
	COBRA 10/7	10	25	
	COBRA 10.5/7	10.5	25	
	COBRA 11/7	11	25	
	COBRA 11.5/7	11.5	25	
8	COBRA 12/8	12	25	
	COBRA 13/8	13	30	
	COBRA 14/8	14	30	
	COBRA 15/8	15	30	
	COBRA 16/8	16	30	
	COBRA 17/8	17	30	
	COBRA 18/8	18	30	
	COBRA 19/8	19	30	
	COBRA 21/8	21	30	

NORMACLAMP® FBS Assortment



NEW!

NORMACLAMP® FBS ASSORTMENT

Designation	Quantity	PA 6 Product No.
FBS 14/12 SW	10 PCS	0112 7024 001
FBS 16/12 SW	10 PCS	
FBS 17/12 SW	10 PCS	
FBS 19/12 SW	10 PCS	
FBS 23/12 SW	10 PCS	
FBS 27/12 SW	5 PCS	
FBS 29/12 SW	5 PCS	
FBS 32/12 SW	5 PCS	
FBS 40/12 SW	5 PCS	
FBS 44/12 SW	5 PCS	

NORMAQUICK® PLAST® Assortment



NORMAPLAST® NORMA QUICK PLAST ASSORTMENT

Designation	Quantity	PA 6 Product No.
NQS NW 8-6 0°	3	0700 2011 000
NQS NW8-6 90°	3	
NQS NW10-8-0°	3	
NQS NW10-8-90°	3	
NQS NW1/4"-1/4"-0°	3	
NQS NW1/4"-1/4"-90°	3	
NQS NW5/16"-06-0°	3	
NQS NW5/16"-06-90°	3	
ADAPTER NQS 5/16"-6-0°	3	
NQS NW3/8"5/16-0°	3	
NQS NW3/8"-5/16-90°	3	
ADAPTER NQSNW3/8"-5/16"-0°	3	
GS 6	5	
TS 6	5	
GS 8	5	
TS 8	5	
GS 10	5	
TS 10	5	

NORMAEXTRA

NEW

**NORMAPLAST® Assortment
type 365 PA 6 and TORRO® W2**



NORMAPLAST® ASSORTMENT TYPE 365 PA 6 AND TORRO W2

Width	Designation	Diameter	Quantity	PA 6 W2 (TORRO) Product No.
NA	GS 4	4	50	0773 9000 365
	TS 4	4	50	
	YS 4	4	50	
	GS 6	6	25	
	TS 6	6	25	
	YS 6	6	25	
	GS 8	8	20	
	TS 8	8	10	
	YS 8	8	10	
	GRS 8 - 6	8	20	
7.5	TORRO 8 - 12/7.5	8 - 12	40	
	TORRO 10 - 16/7.5	10 - 16	40	

NORMACLAMP® TORRO® Dispenser



NORMACLAMP® TORRO DISPENSER				
Width	Designation	Clamping range	Quantity	W2 Product No.
7.5	TORRO 8 - 12/7.5	8 - 12	10	0126 9702 010
9	TORRO 8 - 16/9	8 - 16	10	
	TORRO 12 - 22/9	12 - 22	10	
	TORRO 16 - 27/9	16 - 27	10	
	TORRO 20 - 32/9	20 - 32	10	
	TORRO 25 - 40/9	25 - 40	10	
	TORRO 32 - 50/9	32 - 50	10	
	TORRO 40 - 60/9	40 - 60	10	
	TORRO 50 - 70/9	50 - 70	10	
	TORRO 60 - 80/9	60 - 80	10	

NORMACLAMP® TORRO® Drawer box



NORMACLAMP® TORRO DRAWER BOX				
Width	Designation	Clamping range	Quantity	W2 Product No.
9	TORRO 8 - 16/9	8 - 16	155	0126 9702 450
	TORRO 12 - 22/9	12 - 22	60	
	TORRO 16 - 27/9	16 - 27	100	
	TORRO 20 - 32/9	20 - 32	50	
	TORRO 25 - 40/9	25 - 40	50	
	TORRO 32 - 50/9	32 - 50	15	
	TORRO 50 - 70/9	50 - 70	20	

NORMACLAMP® TORRO® Pallet



NORMACLAMP® TORRO PALLET					
Width	Designation	Clamping range	Quantity	W1 Product No.	W4 Product No.
9	TORRO 8 - 16/9	8 - 16	40	0126 5006 012	0126 5006 015
	TORRO 12 - 22/9	12 - 22	25		
	TORRO 16 - 27/9	16 - 27	20		
	TORRO 20 - 32/9	20 - 32	15		
	TORRO 25 - 40/9	25 - 40	10		
	TORRO 35 - 50/9	35 - 50	10		
NA	FLEXIDRIVER	NA	1		

NORMACLAMP® Quick lock Band-on-roll dispenser



NORMACLAMP® QUICK LOCK BAND-ON-ROLL DISPENSER				
Width	Designation	Length in m	W2 Product No.	W4 Product No.
9	BAND-ON-ROLL 3M	3	0815 5007 015	0815 5007 014
	BAND-ON-ROLL 5M	5	0815 5007 017	0815 5007 016

NORMAEXTRA

NORMACLAMP® TORRO® Assembly fixture



NORMACLAMP® TORRO® ASSEMBLY FIXTURE

Designation	Product No.
TORRO ASSEMBLY FIXTURE	0126 9900 001

NORMACLAMP® COBRA Pneumatic pliers



These pneumatically assisted pliers are the ideal installation tool for industrial applications, allowing serial installation work involving large quantities to be handled with ease.

NORMACLAMP® COBRA PNEUMATIC PLIERS

Designation	Product No.
COBRA PNEUMATIC PLIERS	0110 8420 010

NORMACLAMP® FBS Pneumatic pliers

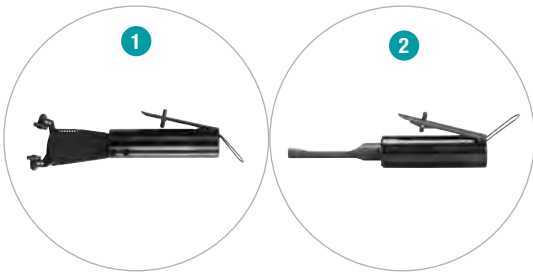

- 1 **Version S**
Suitable for “vertical” assembly operations where the clamp head is approached from above. Ideal for high volume series assembly.
- 2 **Version W**
Suitable for “horizontal” assembly operations where the clamp head is approached from the side. For high volume series assembly.

NORMACLAMP® FBS PNEUMATIC PLIERS TYPE S

Designation	Product No.
FBS PNEUMATIC PLIERS TYPE S	0115 0000 911*1
FBS PNEUMATIC PLIERS TYPE S	0115 0000 912*2

NORMACLAMP® FBS PNEUMATIC PLIERS TYPE W

Designation	Product No.
FBS PNEUMATIC PLIERS TYPE W	0115 0000 919*1
FBS PNEUMATIC PLIERS TYPE W	0115 0000 920*2

*1 jaws are opened before release
*2 jaws are closed before release

NORMACLAMP® FBS C Multi-release tool



For unlocking pre-opened FBS C, only our release tool is permitted.

NORMACLAMP® FBS C MULTI-RELEASE TOOL

Designation	Product No.
FBS C MULTI-RELEASE TOOL	0115 0000 936

NORMACONNECT® FGR
Mounting aid for REP E



NEW!

NORMACONNECT® FGR MOUNTING AID FOR REP E	
Designation	Product No.
FGR REP E MOUNTING AID	0572 0000 001

NORMAFIX® Cable tie pliers



1



2

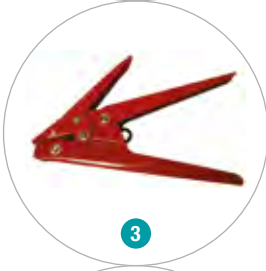

3

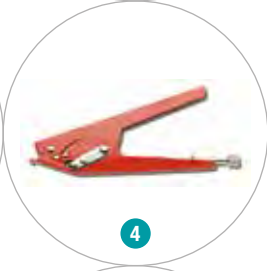

4



5



6

NEW!

1 NORMAFIX® CABLE TIE PLIERS FROM 2.2 TO 4.8 MM	
Designation	Product No.
PLIERS FOR NYLON CABLE TIE FROM 2.2 TO 4.8 MM - SEMI-AUTOMATIC	0860 1000 001

2 NORMAFIX® CABLE TIE PLIERS FROM 4.8 TO 7.8 MM	
Designation	Product No.
PLIERS FOR NYLON CABLE TIE FROM 4.8 TO 7.8 MM - SEMI-AUTOMATIC	0860 1000 004

3 NORMAFIX® CABLE TIE PLIERS FROM 3.6 TO 13 MM	
Designation	Product No.
PLIERS FOR NYLON CABLE TIE FROM 3.6 TO 13 MM - MANUAL	0860 1000 005

4 NORMAFIX® CABLE TIE PLIERS FROM 4.7 TO 13 MM	
Designation	Product No.
PLIERS FOR NYLON CABLE TIE FROM 4.7 TO 13 MM - MANUAL	0892 0000 003

5 NORMAFIX® PLIERS FOR STAINLESS STEEL BALL LOCKING CABLE TIES FROM 3.8 TO 9 MM	
Designation	Product No.
PLIERS FOR STAINLESS STEEL BALL LOCKING CABLE TIES FROM 3.8 TO 9 MM - SEMI-AUTOMATIC	0892 0000 001

6 NORMAFIX® PLIERS FOR STAINLESS STEEL BALL LOCKING CABLE TIES FROM 3.8 TO 9 MM	
Designation	Product No.
PLIERS FOR STAINLESS STEEL BALL LOCKING CABLE TIES FROM 3.8 TO 9 MM - MANUAL	0892 0000 002

NORMAFIX® NORMETTA®
Clamping and cutting tool



This high quality cast tool is recommended for professional work. Easy to use, it provides a tensile force of approximately 10,000 N (1000 KP).

NORMAFIX® NORMETTA CLAMPING AND CUTTING TOOL	
Designation	Product No.
CLAMPING AND CUTTING TOOL	0560 8555 001

NORMAEXTRA

NEW

NORMACLAMP® Earclip pliers



NORMACLAMP® EARCLIP PLIERS

Designation	Product No.
EARCLIP PLIERS END CLOSING	0819 0022 094
EARCLIP PLIERS SIDE CLOSING	0819 0022 095

NORMACLAMP® Earclip pliers for flat mounting



NORMACLAMP® EARCLIP PLIERS FOR FLAT MOUNTING

Designation	Product No.
EARCLIP PLIERS FOR FLAT MOUNTING	0819 0022 161

NORMACLAMP® COBRA Handheld pliers

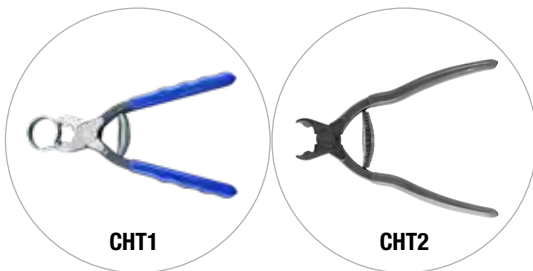

These handheld pliers enable precise installation and removal. The tips of the pliers' head enable a secure grip on the clip's tool gripping points. The integrated smooth-running spring element keeps the pliers open continuously, allowing you to work quickly and comfortably.

CHT 1 allows a connect and disconnect function.
CHT 2 only allows a connection function.

NORMACLAMP® COBRA CHT 1

Designation	Product No.
COBRA CHT 1	0110 8420 000

NORMACLAMP® COBRA CHT 2

Designation	Product No.
COBRA CHT 2	0110 8420 004

NORMACLAMP® FBS Handheld pliers

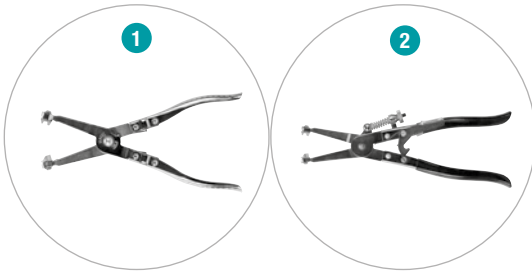

- 1 Type 1: for small nominal diameters (up to 40 mm).
- 2 Type 2: for all diameters, with integrated safety lever for fixing the pliers in position.

NORMACLAMP® FBS PLIERS

Designation	Product No.
FBS PLIERS	0115 0000 903

NORMACLAMP® FBS PLIERS WITH INTEGRATED SAFETY LEVER

Designation	Product No.
FBS PLIERS WITH INTEGRATED SAFETY LEVER	0115 0000 904

Pliers for the FBS R are available on request

NORMAFIX® RSGUV 1 / RSV 1 Handheld pliers



NEW!

For professional installation of RSGUV 1 / RSV 1 clips, two types of handheld pliers are available depending on the band width involved.

NORMAFIX® RSGUV 1 / RSV 1 PLIERS

Designation	Product No.
RSGUV 1 / RSV 1 PLIERS 15	0981 0000 151
RSGUV 1 / RSV 1 PLIERS 20	0981 0000 201

**NORMACLAMP® TORRO® Screwdriver
SW6, SW7, SW6/7**



NORMACLAMP® TORRO® SCREWDRIVER SW6, SW7, SW6/7

Designation	Product No.
SW6	0000 0000 899
SW7	0000 0000 898
SW6/7	0000 0000 894

NORMACLAMP® Tamperproof Screwdriver



NEW!

NORMACLAMP® TAMPERPROOF SCREWDRIVER

Designation	Product No.
TAMPERPROOF SCREWDRIVER	0126 9900 003

NORMACLAMP® Hi-torque T-screwdriver



NORMACLAMP® HI-TORQUE T-SCREWDRIVER

Designation	Product No.
T-SCREWDRIVER FOR HI-TORQUE CLAMP	0560 6600 001

**NORMAFIX® Tube clamp fittings
Hexagonal key**



NORMAFIX® HEXAGONAL KEY

Designation	Diameter in mm	Galvanized steel Product No.
HEXAGONAL KEY 26.9/33.7	26.9/33.7	0819 6332 001
HEXAGONAL KEY 42.4/48.3/60.3	42.4/48.3/60.3	0819 6332 002

NORMAFIX® Tube clamp fittings
Aluminum end cap



NORMAFIX® ALUMINIUM END CAP

Designation	Diameter in mm	Aluminum Product No.
ALUMINIUM END CAP 33.7	33.7	0819 6329 034
ALUMINIUM END CAP 42.4	42.4	0819 6329 042
ALUMINIUM END CAP 48.3	48.3	0819 6329 048

NORMAFIX® Tube clamp fittings
Plastic end cap



NORMAFIX® PLASTIC END CAP

Designation	Diameter in mm	Plastic Product No.
PLASTIC END CAP 33.7	33.7	0819 6330 034
PLASTIC END CAP 42.4	42.4	0819 6330 042
PLASTIC END CAP 48.3	48.3	0819 6330 048

NORMAFIX® Tube clamp fittings
Spare screws



NORMAFIX® SPARE SCREW

Designation	Diameter in mm	Stainless steel Product No.
SPARE SCREW 26.9/33.7	26.9/33.7	0819 6331 001
SPARE SCREW 42.4/48.3/60.3	42.4/48.3/60.3	0819 6331 002

NORMAFIX®
Lamppost protection tape



NORMAFIX® LAMPOST PROTECTION TAPE

Designation	Length in m	PVC Product No.
BLACK EPDM PROTECTION TAPE ROLL OF 10 METERS	10	0560 7640 010
WRAP & SEAL VULCANIZING STRETCHABLE TAPE TAPE - BLACK 2.4 METERS	2.4	0560 7640 002
WRAP & SEAL VULCANIZING STRETCHABLE TAPE TAPE - BLACK 4.8 METERS	4.8	0560 7640 004

NORMAFIX® Cable tie Wall plug bases for cable tie

For fixing cables and pipes to walls. Very easy installation for cable ties up to 9 mm width.



NORMAFIX® WALL PLUG BASES FOR CABLE TIES			
Designation	PA 6.6		
	White	Black	Grey
	Product No.	Product No.	Product No.
WALL PLUG BASES FOR CABLE TIES WITHOUT FINS 8 MM BASE	0860 0701 002	0860 0701 001	
WALL PLUG BASES FOR CABLE TIES WITH FINS 6 MM BASE	0860 0701 112	0860 0701 111	0860 0703 111
WALL PLUG BASES FOR CABLE TIES WITH FINS 8 MM BASE	0860 0701 102	0860 0701 101	0860 0703 101

NORMAFIX® Cable tie Mounting bases for cable tie

For fixing cables and pipes to walls. Very easy installation for cable ties up to 9 mm width.



NORMAFIX® MOUNTING BASES FOR CABLE TIES WITHOUT ADHESIVE									
Number of entrances	Designation	For cable ties band width	Dimensions (mm)					PA 6.6	
			A	B	C	F	H	White	Black
			Product No.	Product No.					
1	MOUNTING BASES FOR CABLE TIES WITHOUT ADHESIVE 3.6	3.6	19	19	4.2	4	5	0860 0811 001	0860 0812 001
	MOUNTING BASES FOR CABLE TIES WITHOUT ADHESIVE 4.8	4.8	27	27	4.2	6	7.4	0860 0811 002	0860 0812 002
2	MOUNTING BASES FOR CABLE TIES WITHOUT ADHESIVE 3.6	3.6	19	19	4.1	4	5	0860 0911 001	0860 0912 001
	MOUNTING BASES FOR CABLE TIES WITHOUT ADHESIVE 4.8	4.8	27	27	4.8	6	6.5	0860 0911 002	0860 0912 002

NORMAFIX® MOUNTING BASES FOR CABLE TIES WITH ADHESIVE									
Number of entrances	Designation	For cable ties band width	Dimensions (mm)					PA 6.6	
			A	B	C	F	H	White	Black
			Product No.	Product No.					
1	MOUNTING BASES FOR CABLE TIES WITH ADHESIVE 3.6	3.6	19	19	4.2	4	5	0860 0831 001	0860 0832 001
	MOUNTING BASES FOR CABLE TIES WITH ADHESIVE 4.8	4.8	27	27	4.2	6	7.4	0860 0831 002	0860 0832 002
2	MOUNTING BASES FOR CABLE TIES WITH ADHESIVE 3.6	3.6	19	19	4.1	4	5	0860 0931 001	0860 0932 001
	MOUNTING BASES FOR CABLE TIES WITH ADHESIVE 4.8	4.8	27	27	4.8	6	6.5	0860 0931 002	0860 0932 002



NOTES

A series of horizontal dotted lines for writing notes.

NORMA®

NORMACLAMP®

NORMACONNECT®

NORMAFIX®

NORMAPLAST®

are registered trademarks of NORMA Germany GmbH.

NORMA Group

Postfach 11 49 · D-63461 Maintal

Edisonstraße 4 · D-63477 Maintal

Tel: +49 (61 81) 4 03-0

Fax: +49 (61 81) 4 03-210

www.normagroup.com

info@normagroup.com



This catalogue supersedes all previous issues. No part of this publication may be reproduced without our prior written consent. In NORMA Group's policy of continual product improvements to meet user needs and technological developments, all models and sets listed in this folder (photographs, specifications, sizes and weights) may be upgraded or discontinued without notice and without any obligation on our part to modify tools or equipment sold previously. The recommendations for use and safety given in this folder do not replace accepted good practice or the safety related legal and regulatory provisions. References to standards implemented as of September 15th, 2019 are not contractually binding.

